

## Serie G38 >

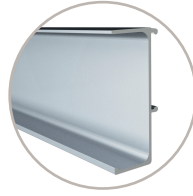
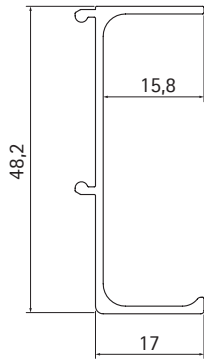

Code	mm	m	kg	m
80/G38.AL	4.200	42	18	42

Profilo gola orizzontale / verticale singola  
Horizontal gola system / single vertical

## Serie G39 >

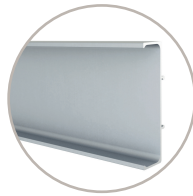
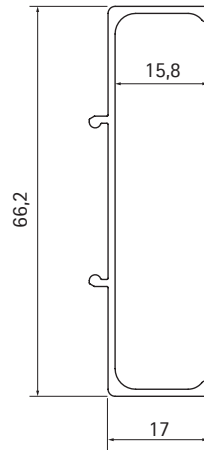

Code	mm	m	kg	m
80/G39.AL	4.200	42	18	42

Profilo gola orizzontale per cassetti / verticale doppia  
Horizontal gola system for drawers / double vertical

## Serie G43 >

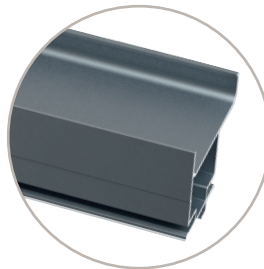
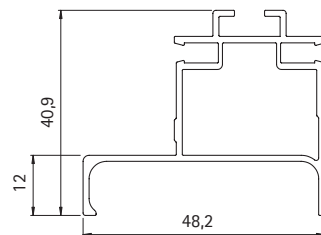

Code	mm	m	kg	m
80/G43.AL	4.700	37,6	23	37,6

Gola prof. 12 sottotop/terminale verticale per utilizzo con basette lineari  
12 mm deep gola for top/terminal vertical for linear base use

## Serie G44 >

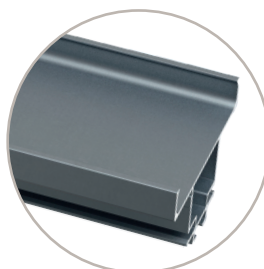
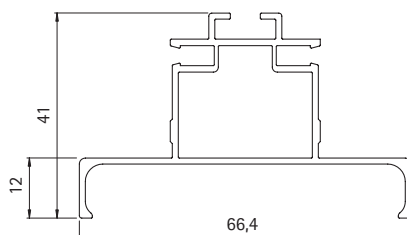

Code	mm	m	kg	m
80/G44.AL	4.700	37,6	26	37,6



Gola prof. 12 cassetto/centrale verticale per utilizzo con basette lineari  
12 mm deep gola for drawer/central vertical for linear base use

## Serie G38 - G39 >

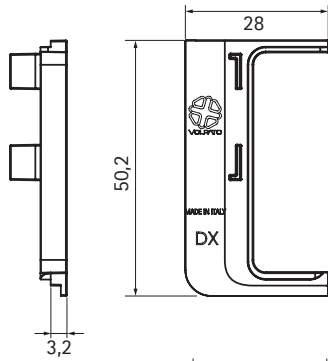
### Accessori Accessories



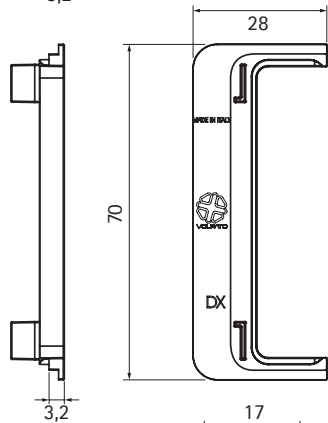

Set tappi terminali esterni  
External caps set

Code	 pcs	 kg	 pcs
81/G38.AT2	50	0,4	50



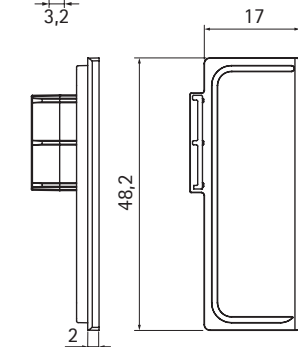

Set tappi terminali esterni  
External caps set

Code	 pcs	 kg	 pcs
81/G39.AT2	50	0,45	50



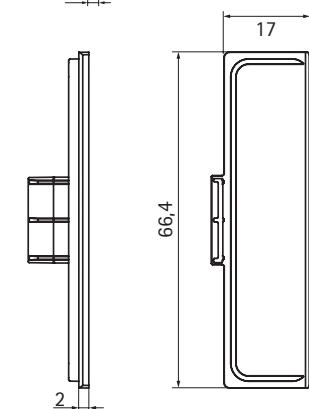

Set tappi terminali interni  
Set internal caps

Code	 pcs	 kg	 pcs
81/G38.AT3	50	0,3	50



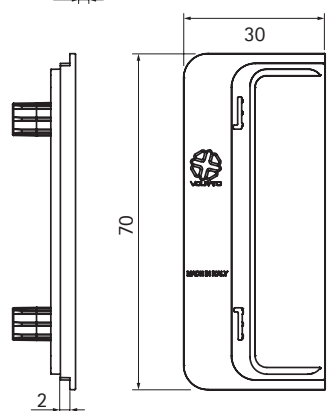

Set tappi terminali interni  
Set internal caps

Code	 pcs	 kg	 pcs
81/G39.AT3	50	0,4	50



Tappo terminale esterno lavastoviglie  
Dishwasher external caps

Code	 pcs	 kg	 pcs
81/G39.AT5	50	0,4	50