

Guida all'installazione | installation guide

> Step 1

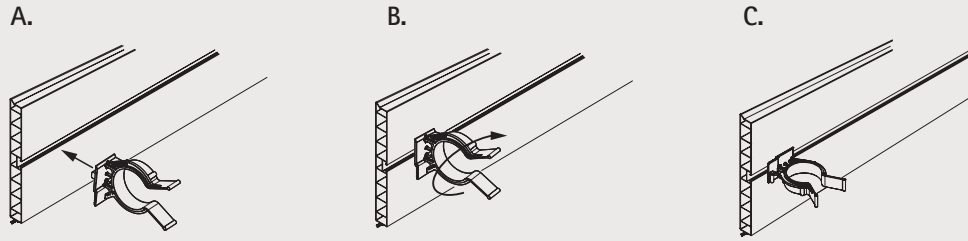

> Step 2

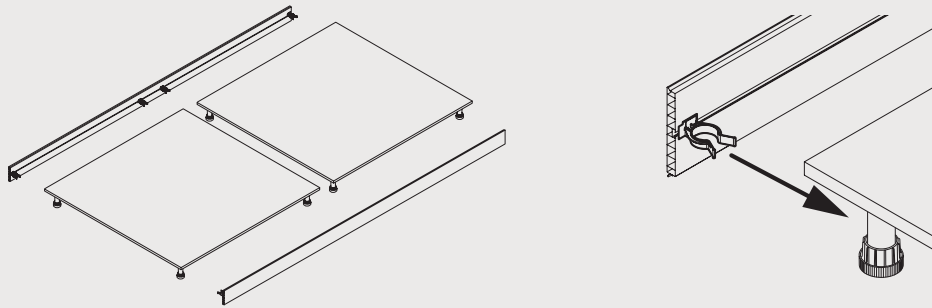

> Step 3



> Step 4

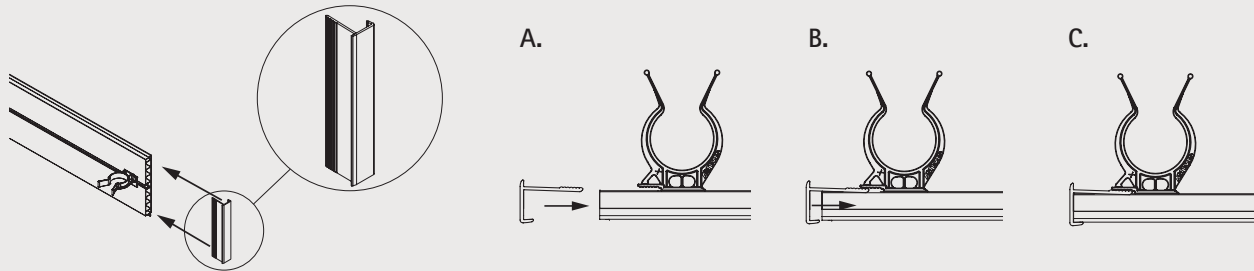

> Step 5

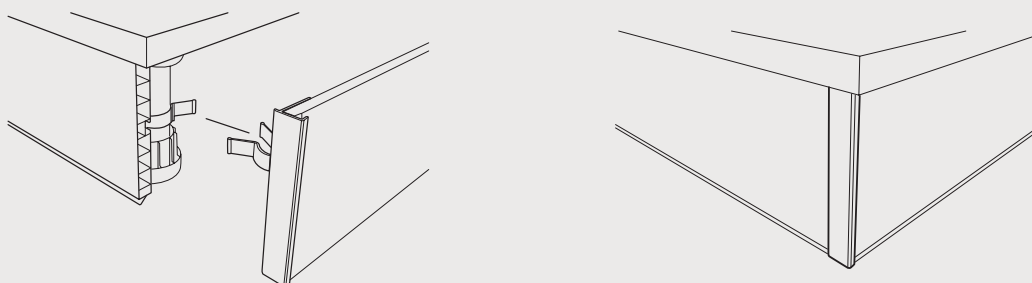

Serie 1R AL > Zoccoli in alluminio Aluminium plinths

Tipologia di altezze e profili disponibili Types of heights and profiles available

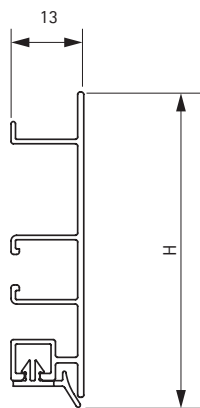

Profilo Serie 1R AL
Serie 1R AL profile



Profilo Serie 1R ALR
Serie 1R ALR profile



Code	mm	mm	m	kg	m
20/1R.400AL	60	4.000	60	18	180
20/1R.400ALR	60	4.000	48	26	144

Guarnizione a semi-scomparsa
Anodised, semi-hidden gasket

Pezzi speciali Special pieces



24/1R.AL
24/1R.AL.R



22/1R. AL
22/1R. AL.R



23/1R. AL
23/1R. AL.R

Accessori Accessories >

Serie 1R AL - 1R ALR



Angolo 90°
Corner 90°



Code	mm	pcs
21/29.5R	60	100



Angolo 135°
Corner 135°



Code	mm	pcs
21/29.3R	60	100

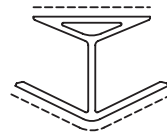

Multiangolo con snodo
Multicorner with joint



Code	mm	pcs
21/29DR.AL	60	100

Alluminio anodizzato
Anodized aluminum



Multiangolo con snodo
Multicorner with joint



Code	mm	pcs
21/29DR.AL	60	100

Alluminio rivestito
Coated aluminum



Angolo jolly
Jolly corner



Code	mm	pcs
21/19.HR	60	100

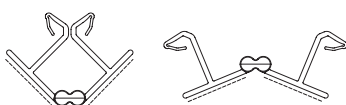

Giunzione
Joint



Code	mm	pcs
21/29.2R	60	100

