

### Guida all'installazione | installation guide

> Step 1

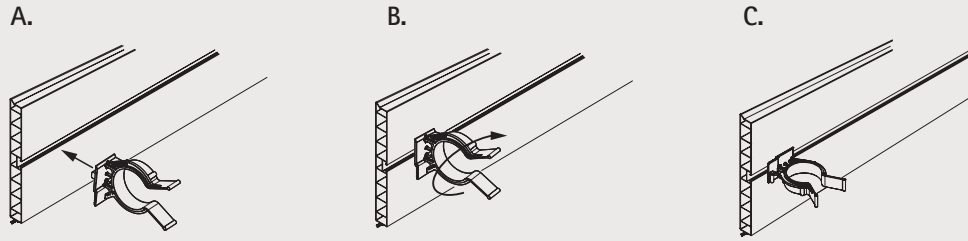

> Step 2

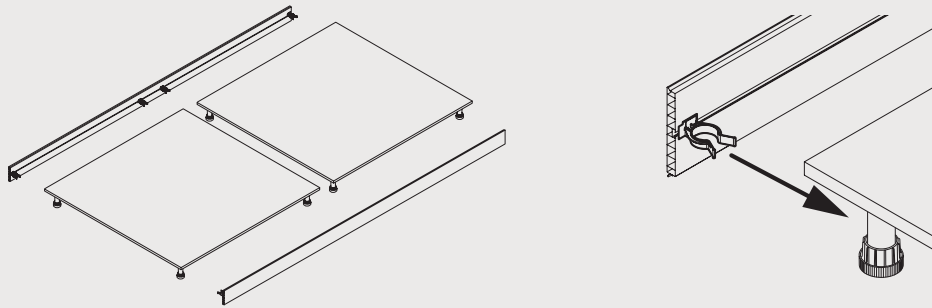

> Step 3



> Step 4

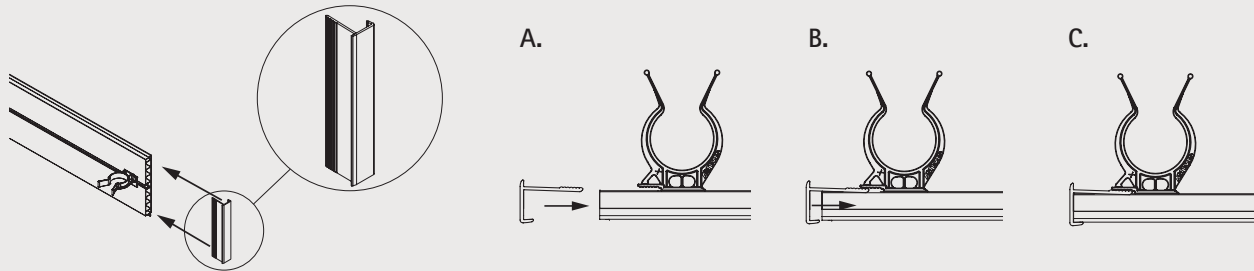

> Step 5

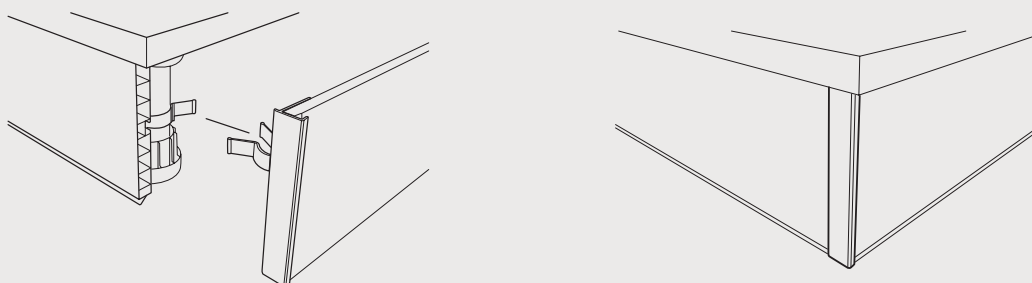

## Serie 10 MR > Zoccoli in alluminio Aluminium plinths

Tipologia di altezze e profili disponibili Types of heights and profiles available

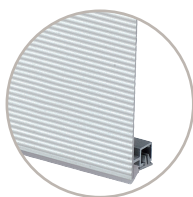
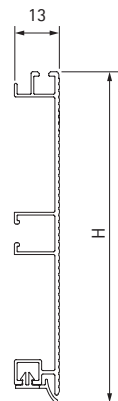

Millerighe anodizzato,  
guarnizione a semi-scomparsa  
Millerighe anodised,  
semi-hidden gasket



Code	mm	mm	m	kg	m
20/10.400MR	100	4.000	60	31	180
20/12.400MR	120	4.000	60	34	180
20/15.400MR	150	4.000	48	32	240
20/18.400MR	180	4.000	40	34	200

### Pezzi speciali Special pieces

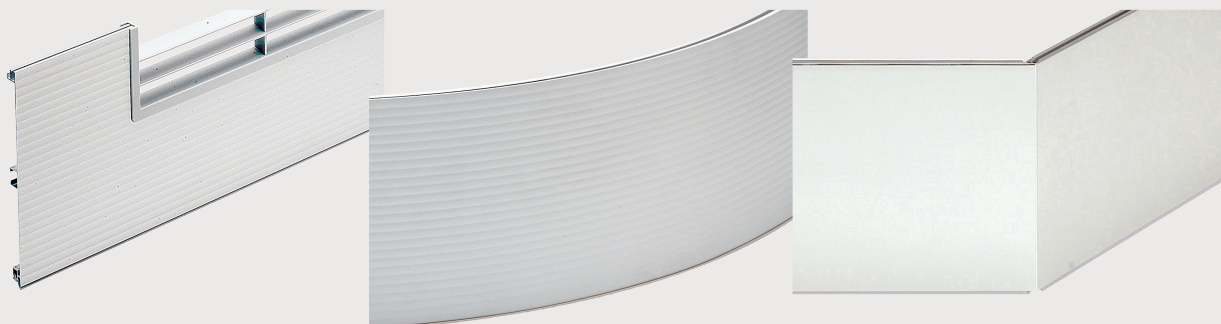

24/10.449.MR  
24/12.449.MR  
24/14.449.MR  
24/15.449.MR  
24/18.449.MR

22/10.MR  
22/12.MR  
22/14.MR  
22/15.MR  
22/18.MR

23/10. MR  
23/12. MR  
23/14. MR  
23/15. MR  
23/18.MR

## Accessori Accessories >

Serie 1T 10-12-15-16-18-1A AL  
10-12-14-15-18 CR  
10-12-15-18 MR

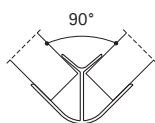

Angolo 90° A1  
Corner 90° A1

Code	mm	pcs
21/291T.AL	80	100
21/2910.AL	100	100
21/2912.AL	120	100
21/2914.AL	140	100
21/2915.AL	150	100
21/2916.AL	160	100
21/2918.AL	180	100
21/291A.AL	200	100

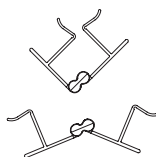

Multiangolo  
Multicorner

Code	mm	pcs
21/29DT.AL	80	100
21/29D0.AL	100	100
21/29D2.AL	120	100
21/29D4.AL	140	100
21/29D5.AL	150	100
21/29D6.AL	160	100
21/29D8.AL	180	100
21/29DA.AL	200	100

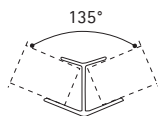

Angolo 135° AB  
Corner 135° AB

Code	mm	pcs
21/29BT.AL	80	100
21/29B0.AL	100	100
21/29B2.AL	120	100
21/29B4.AL	140	100
21/29B5.AL	150	100
21/29B6.AL	160	100
21/29B8.AL	180	100
21/29BA.AL	200	100

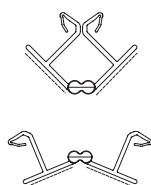

Angolo jolly  
Jolly corner

Code	mm	pcs
21/19HT	80	100
21/19H0	100	100
21/19H2	120	100
21/19H4	140	100
21/19H5	150	100
21/19H6	160	100
21/19H8	180	100
21/19HA	200	100