

Zoccoli in plastica rivestiti

Coated Plastic plinths

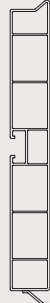

Serie 10
pag.64



Serie 20
pag.65

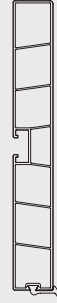

Serie 50
pag.68



Serie 80
pag.70

La Volpato Industrie è in grado di fornire un vasto assortimento di zoccoli, in tutte le altezze richieste. Sono realizzati in compound termoplastico rigido o in lega di alluminio e sono dotati di guarnizione realizzata in compound morbido.

Gli zoccoli in termoplastico sono rivestiti con le finiture richieste, i profili in lega di alluminio sono provvisti di una finitura anodizzata a scopo protettivo e decorativo. Inoltre sono completati da una serie di pezzi speciali personalizzati e da diverse serie di accessori angolo in grado di soddisfare tutte le esigenze di design del mobile.

Volpato Industrie produces a wide range of plinths, available in all heights required. Our plinths are produced in thermoplastic compound or in aluminum alloy always with a soft bottom gasket. Plastic plinths are wrapped with foils made by various materials, plinths in aluminum alloy have different finishes and are anodized for aesthetical and functional purposes. All plinth series can be integrated with special pieces tailor-made for the customer and all corners and connectors needed for furniture construction.

Guida all'installazione | installation guide

> Step 1

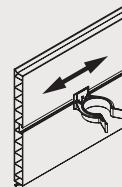
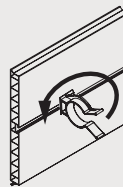
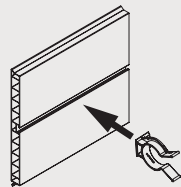

> Step 2

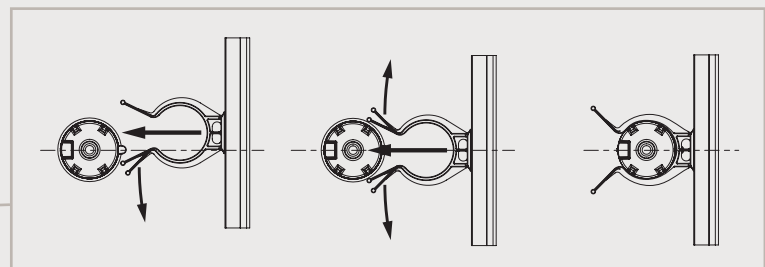
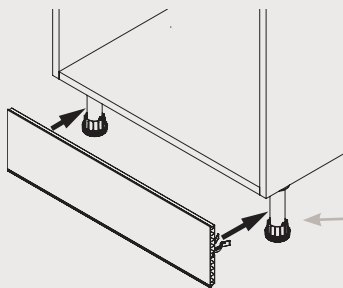

Serie 20 > Zoccoli in plastica rivestiti Plastic coated plinths

Tipologia di altezze e profili disponibili Types of heights and profiles available

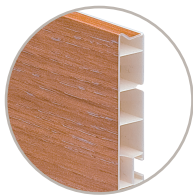
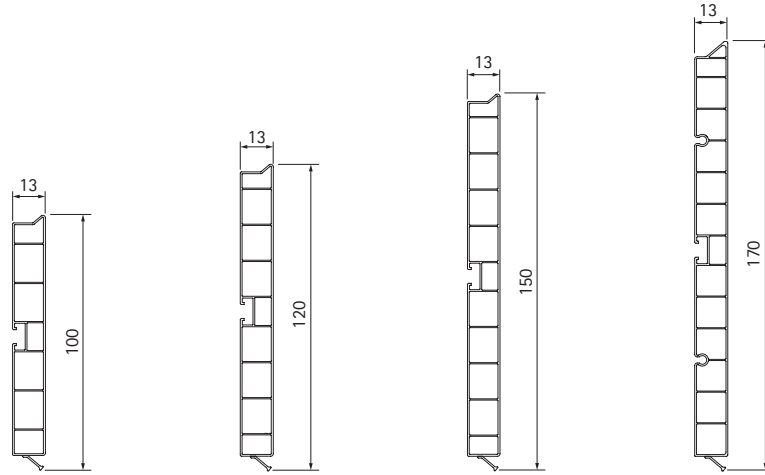

Profilo superiore
Serie 20/22/25/27
Serie 20/22/25/27/ profile



Code	mm	mm	m	kg	m
20/20.400	100	4.000	60	18	180
20/22.400	120	4.000	60	24	180
20/25.400	150	4.000	48	23	144
20/27.400	170	4.000	48	24	144

Finitura: rivestito.
Finish: coated.

Pezzi speciali Special pieces



24/20.449
24/22.449
24/25.449
24/27.449

22/20.
22/22.
22/25.
22/27.

23/20.
23/22.
23/25.
23/27.

Accessori Accessories >

Serie 1T-08-10-12-13-14-15
Serie 20-22-25-27

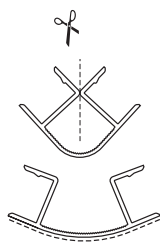

Multiangolo 90°
Multicorner 90°

Code	mm	pcs
21/195T	80	200
21/1950	100	200
21/1952	120	200
21/1953	130	200
21/1954	140	200
21/1955	150	200
21/1957	170	200

Adatto a realizzare angoli esterni con
apertura compresa tra 90° e 135°.
Suitable for external corners with spread
between 90° and 135°.

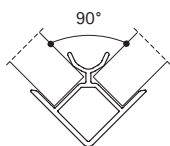

Code	mm	pcs
21/19FT	80	200
21/19F0	100	200
21/19F2	120	200
21/19F3	130	200
21/19F4	140	200
21/19F5	150	200
21/19F7	170	200

Angolo 90°
Corner 90°

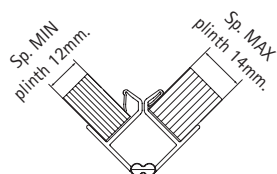

Code	mm	pcs
21/19.HT	80	100
21/19.H0	100	100
21/19.H2	120	100
21/19.H3	130	100
21/19.H4	140	100
21/19.H5	150	100
21/19.H7	170	100

Angolo Jolly
Jolly corner
Pag.62

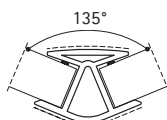

Code	mm	pcs
21/19GT	80	200
21/19G0	100	200
21/19G2	120	200
21/19G3	130	200
21/19G4	140	200
21/19G5	150	200
21/19G7	170	200

Angolo 135°
Corner 135°