



Living Top 30 kg

Slides for suspended panels
Sistemi di scorrimento per ante sospese



Living Top

30 kg

Adjustable sliding system for suspended panels with damped and standard stops.

Sistema di scorrevoli regolabili per ante sospese con fermi ammortizzati e standard.



The ideal solution that grants the highest aesthetic results

Living Top is an adjustable system with upper sliding, designed for wooden doors weighing up to 30 kg and with soft-closing option.

The system represents the best solution to realize applications with clean and linear aesthetic, thanks to flat-bottom with no lower profiles needed.

Living Top is extremely easy to install, thanks to sliding trolleys automatic fastening system.

Living Top is the ideal solution from Terno Scorrevoli dedicated to living spaces, offices and contract.

La soluzione ideale che garantisce un alto livello estetico

Living Top è un sistema regolabile a scorrimento superiore per ante in legno fino a 30 kg con fermi ammortizzati.

Il sistema rappresenta la soluzione ottimale per ottenere un'estetica pulita e lineare, grazie all'assenza di profili inferiori.

Living Top è estremamente semplice da installare, grazie ai sistemi automatici di aggancio degli scorrevoli.

Living Top è la soluzione ideale di Terno Scorrevoli per la zona giorno, l'ufficio o il settore contract.



Living Top 30 kg



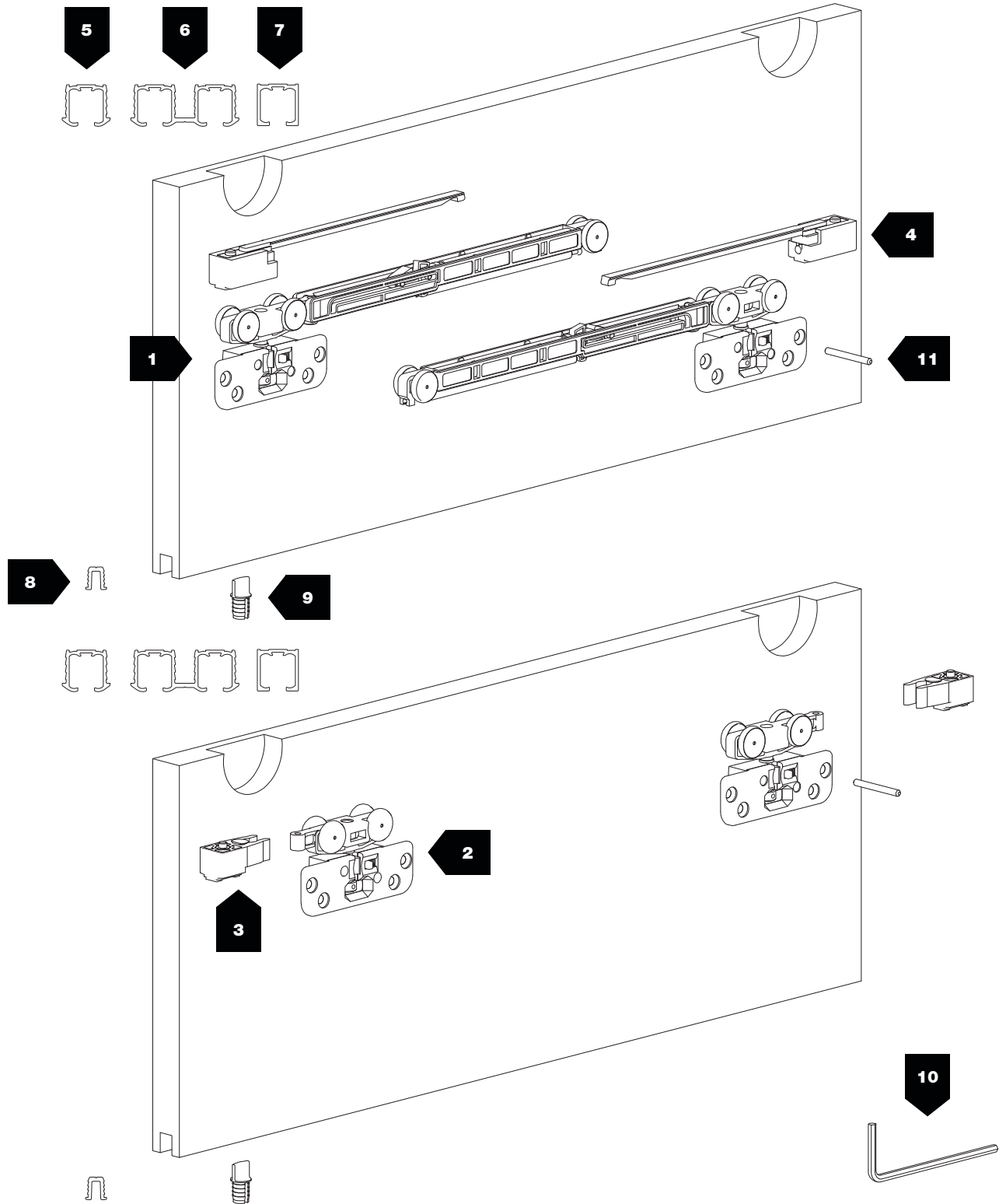



Slides for suspended panels
Sistemi di scorrimento per ante sospese

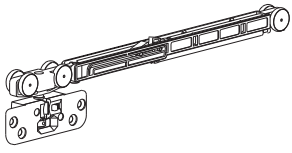
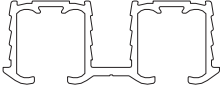
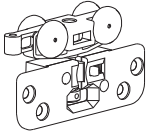
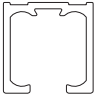
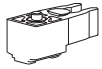

Min. 400 mm



Max 30 Kg

N°	Barcode		kg		N°	Barcode		kg	
1	2654		30		6	2652 8 00 0.02652 8 01 0.02652		30	
2	2656		30		7	2651 8 00 0.02651 8 01 0.02651		30	
3	2657		30		8	2170 8 00 0.02170 8 01 0.02170		30	
4	2655		30		9	2168		30	
5	2650 8 00 0.02650 8 01 0.02650		30		10	437		30	
					11	973		30	



Living Top 30 kg

Slides for suspended panels
Sistemi di scorrimento per ante sospese

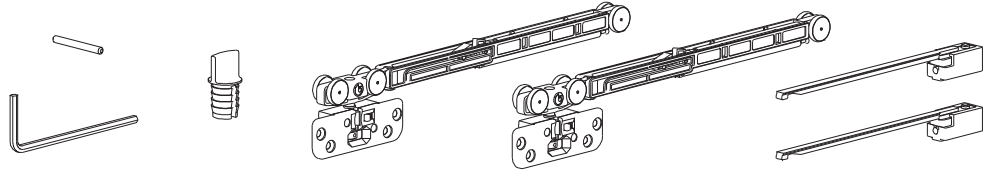
-  Kit for N.1 door
Kit per N.1 anta
-  N.2 Soft damper stoppers
N.2 Fermi ammortizzati



OLD CODE	NEW CODE		
2654/A/2	K.1252.2	30 kg	10x

-  Kit for N.1 door
Kit per N.1 anta
-  N.1 Soft damper stoppers
N.1 Fermi ammortizzati
-  N.1 Standard stoppers
N.1 Fermi standard

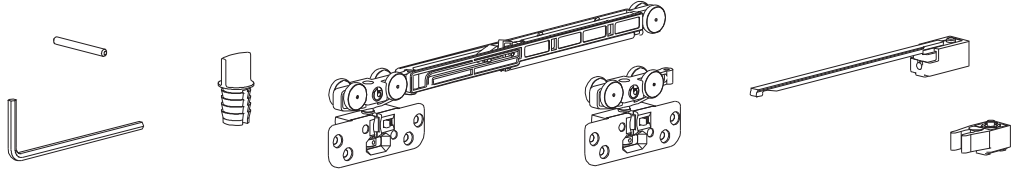

OLD CODE	NEW CODE		
2654/A/1	K.1252.3	30 kg	10x

-  Kit for N.1 door
Kit per N.1 anta
-  N.2 Standard stoppers
N.2 Fermi standard

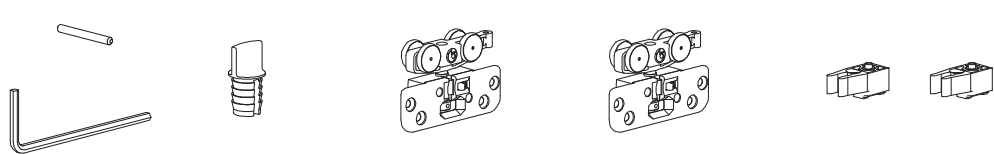

OLD CODE	NEW CODE		
2656/A	K.1252.1	30 kg	10x

MEASUREMENTS DESCRIPTION / DESCRIZIONE MISURE

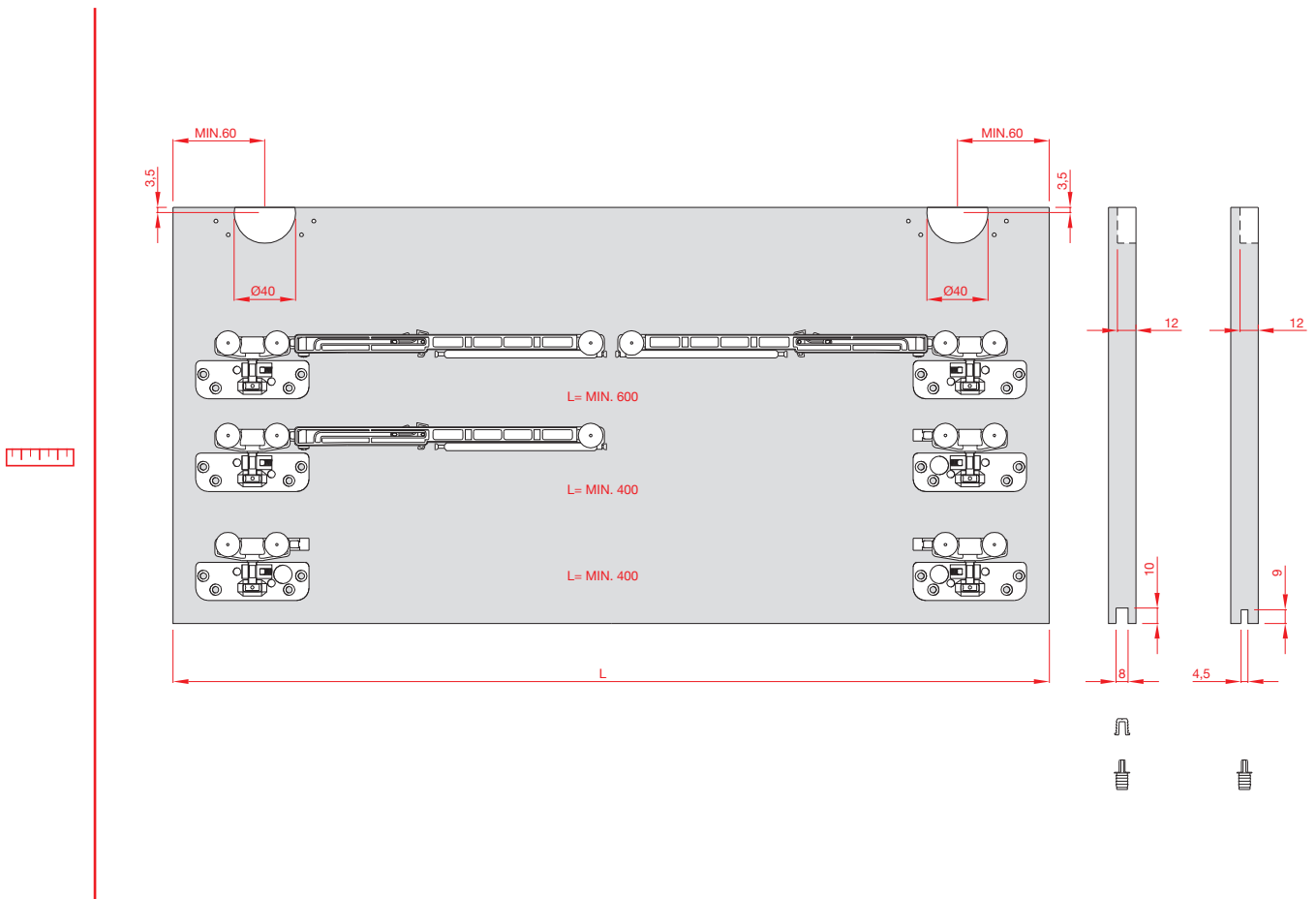

MEASUREMENTS DESCRIPTION / DESCRIZIONE MISURE

