



**terno<sup>®</sup> scorrevoli**  
MADE IN ITALY



# Zig Zag Wardrobe

Sliding systems for wardrobe folding doors  
Sistemi di scorrimento per ante a libro  
per armadi

[www.ternoscorrevoli.com/zig-zag-wardrobe](http://www.ternoscorrevoli.com/zig-zag-wardrobe)

# Zig Zag Wardrobe

**Zig Zag Wardrobe** is a sliding system designed for **cabinets with folding hinged doors**, single or multiple, weighing maximum 10 kg each pannel.

**Zig Zag Wardrobe** system allows a **lateral or central doors opening**, not requiring any on-sight accessory or profile installed on the bottom side, granting so a minimal design and an easy access to compartment.

**Zig Zag Wardrobe** è un sistema scorrevole per **armadi con ante a libro incernierate**, singole o multiple, progettato per portate fino ad un massimo di 10 kg per pannello.

L'installazione del sistema **Zig Zag Wardrobe** consente un'**apertura sia laterale che centrale**, garantendo un **design minimal e pulito** ed un accesso al vano senza ostacoli.





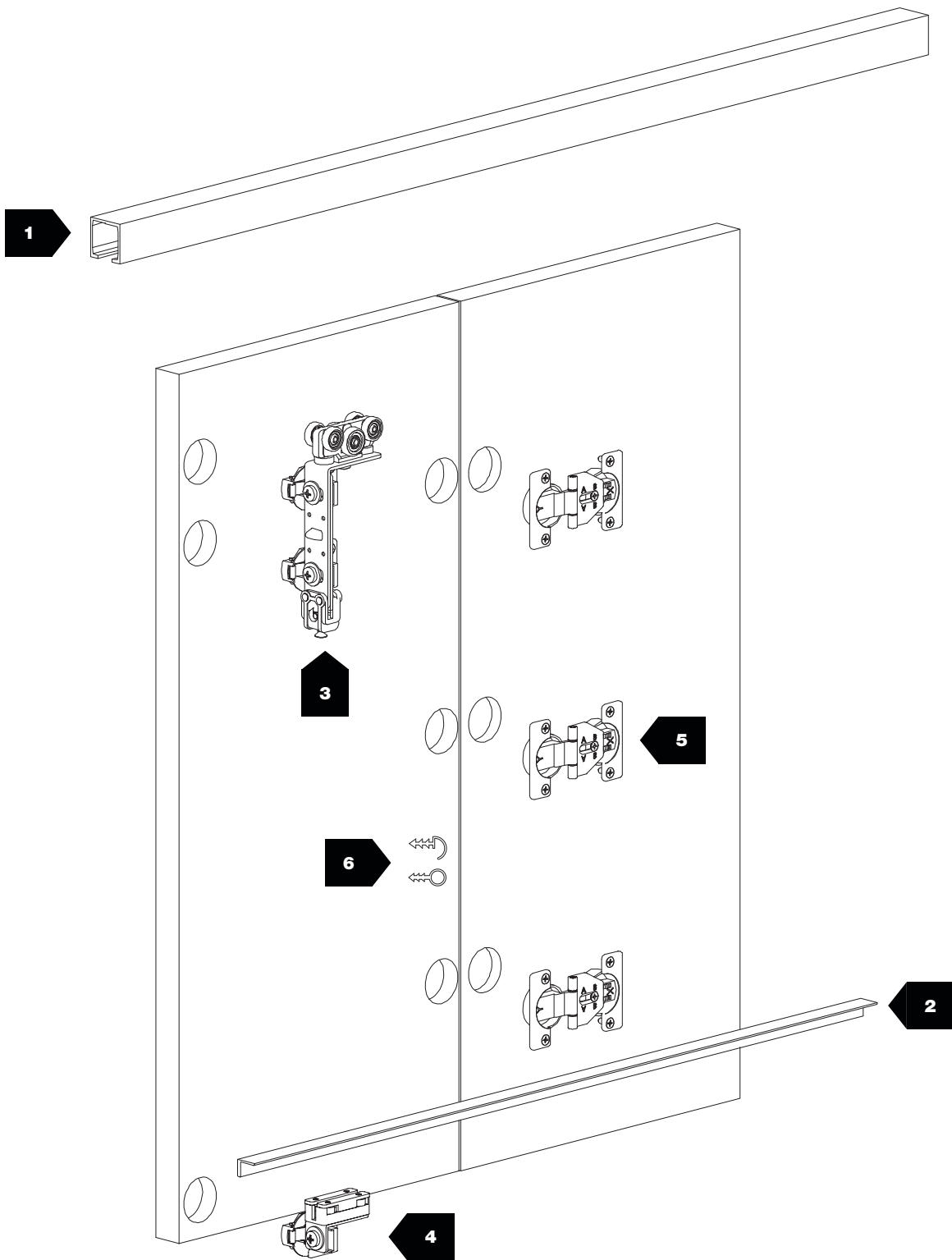

# Zig Zag Wardrobe

Sliding systems for wardrobe folding doors  
Sistemi di scorrimento per ante a libro per armadi



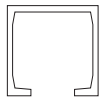
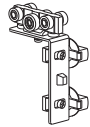
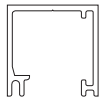
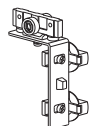

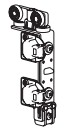
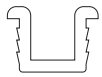
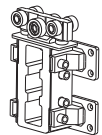
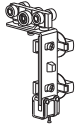
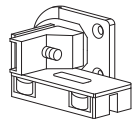
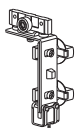
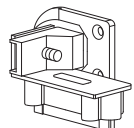

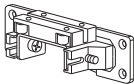
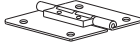
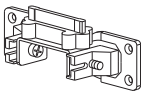

10 kg

| N° | Barcode                              |   | kg |   | N° | Barcode                   |   | kg |  |
|----|--------------------------------------|---|----|---|----|---------------------------|---|----|--|
| 1  | 1080<br>8 00 0.01080<br>8 01 0.01080 |    | 10 |   | 3  | 872<br>S.1321.3           |    | 10 |  |
|    | 1081<br>8 00 0.01081<br>8 01 0.01081 |    | 10 |   |    | 871/C.S.<br>S.871/C.S.-NK |    | 10 |  |
| 2  | 870<br>8 00 0.00870<br>8 01 0.00870  |   | 10 | ONLY<br>ART.875<br>ART.876                                      | 4  | 862<br>S.1321.1           |   | 10 |  |
|    | 730<br>8 01 0.00730                  |  | 10 | ONLY<br>ART.877<br>—<br>Plastic track<br>Binario in<br>plastica |    | 873<br>S.873-NK           |  | 10 |  |
| 3  | 869<br>S.1321.2                      |  | 10 |   | 4  | 876<br>S.876-NK           |  | 10 |  |
|    | 868/C.S.<br>S.868/C.S.-NK            |  | 10 |   |    | 875<br>S.875-NK           |  | 10 |  |

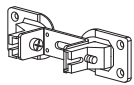
# Zig Zag Wardrobe

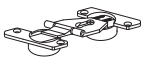
Sliding systems for wardrobe folding doors  
Sistemi di scorrimento per ante a libro per armadi

| N° | Barcode         | kg  | N° | Barcode             | kg  |   |    |
|----|-----------------|---|----|---------------------|---|---|----|
| 4  | 878<br>S.878-NK |    | 10 | 5                   | 883<br>S.883  |    | 10 |
|    | 877<br>S.877-NK |    | 10 |                     | 888<br>S.1311.1   |    | 10 |
|    | 874<br>S.874-NK |  | 10 |                     | 892<br>8 23 0.00892   |  | 10 |
| 5  | 879<br>S.1322.4 |  | 10 | 894<br>8 14 0.00894 |  | 10  |    |

| Tracks / Binari |   | ALUMINUM FINISHES CODES / CODICI FINITURE ALLUMINIO |                                     |  |
|-----------------|---|---|-------------------------------------|---|
| CODE / CODICE   |   | FINISH COLOR / COLORE FINITURA                      |                                     |   |
| 8 00 0.0 .....  |  | 00 G  | Raw / Mill Finish / Neutro / Grezzo | STANDARD  |
| 8 01 0.0 .....  |  | 01 A  | Anodized Silver / Argento           |   |
| 8 14 0.0 .....  |  | 14 N  | Anodized Black / Nero               |   |

| Tracks / Binari |   | PLASTIC FINISHES CODES / CODICI FINITURE PLASTICA |                           |  |
|-----------------|---|---|---------------------------|---|
| CODE / CODICE   |   | FINISH COLOR / COLORE FINITURA                    |                           |   |
| 8 01 0.0 .....  |  | 01 A  | Anodized Silver / Argento | STANDARD  |
| 8 14 0.0 .....  |  | 14 N  | Anodized Black / Nero     |   |
| 8 23 0.0 .....  |  | 23 GR   | Gray / Grigio             |   |

**SLIDE WITH TWO BEARINGS WITH HORIZONTAL AND VERTICAL ADJUSTMENT / SCORREVOLE A DUE CUSCINETTI CON REGOLAZIONE ORIZZONTALE E VERTICALE**

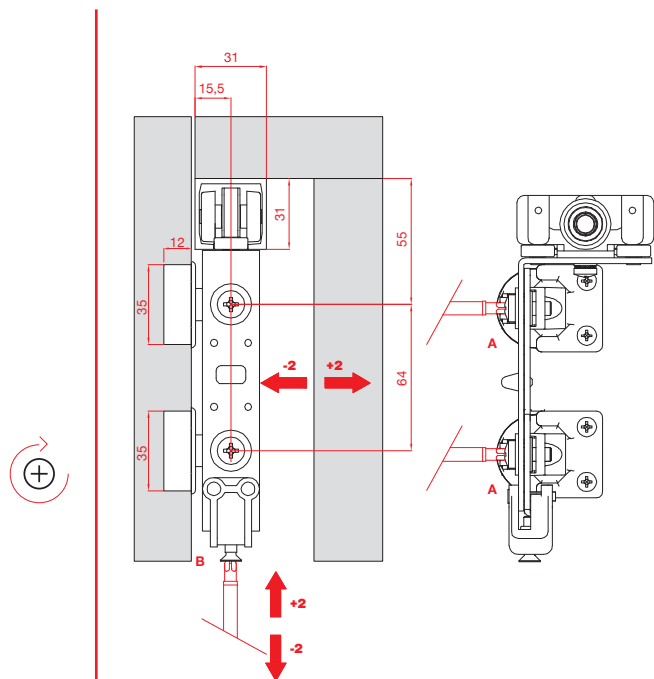

Use screws **A** for horizontal adjustment, lock them when finished. For vertical adjustment: loosen screws **A**, adjust screw **B**, lock screws **A**.  
Per la regolazione orizzontale: agire sulle viti **A**, regolare e bloccare. Per la regolazione verticale: allentare le viti **A**, agire con la vite **B**, infine bloccare le viti **A**.

**ART. 868/C.S.**  
**S.868/C.S.-NK**

**SLIDE WITH SIX BEARINGS WITH HORIZONTAL AND VERTICAL ADJUSTMENT / SCORREVOLE A SEI CUSCINETTI CON REGOLAZIONE ORIZZONTALE E VERTICALE**

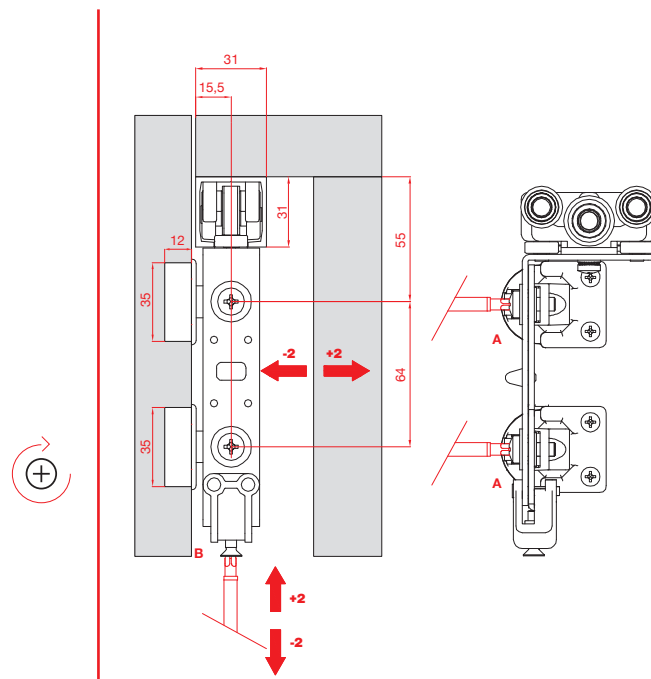

Use screws **A** for horizontal adjustment, lock them when finished. For vertical adjustment: loosen screws **A**, adjust screw **B**, lock screws **A**.  
Per la regolazione orizzontale: agire sulle viti **A**, regolare e bloccare. Per la regolazione verticale: allentare le viti **A**, agire con la vite **B**, infine bloccare le viti **A**.

**ART. 869**  
**S.1321.2**

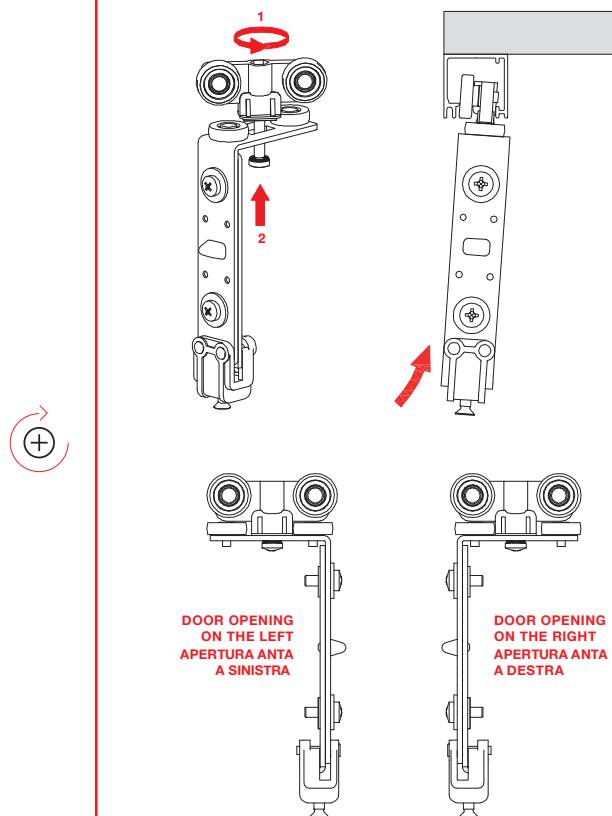

**DOOR OPENING ON THE LEFT**  
**APERTURA ANTA A SINISTRA**

**DOOR OPENING ON THE RIGHT**  
**APERTURA ANTA A DESTRA**

**ART. 862**  
**S.1321.1**

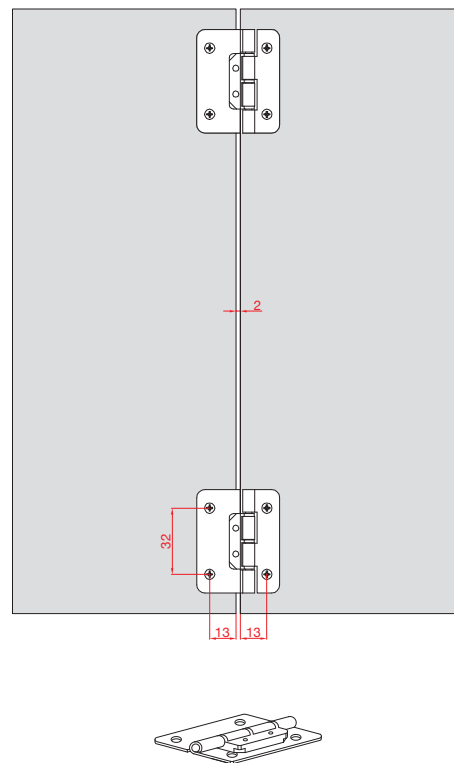

Hinge with moved axis that facilitates the closure of the door  
Cerniera con asse spostato che facilita una migliore chiusura

**ART. 888**  
**S.1311.1**

# Zig Zag Wardrobe

Sliding systems for wardrobe folding doors  
Sistemi di scorrimento per ante a libro per armadi

## SYSTEM FOR HINGED FOLDING DOOR SISTEMA PER ANTA A LIBRO INCERNIERATA



Biextended anti-dust profile  
Profilo biesteso parapolvere

**ART. 892**  
8 23 0.00892

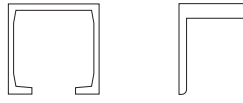

Aluminium track  
Binario in alluminio

**ART. 1080**  
8 00 0.01080  
8 01 0.01080

**ART. 870**  
8 00 0.00870  
8 01 0.00870

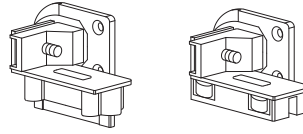

One-hinge slider  
Scorrevole con una cerniera

**ART. 875**  
S.875-NK

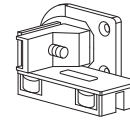

Adjustable slide with 6 bearings  
Scorrevole regolabile con 6 cuscinetti

**ART. 869**  
S.1321.2



Hinge  
Cerniera

**ART. 879**  
S.1322.4

**ART. 888**  
S.1311.1

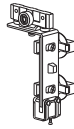

Adjustable slide with 2 bearings  
Scorrevole regolabile con 2 cuscinetti

**ART. 868/C.S.**  
S.868/C.S.-NK

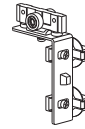

Slide with 2 bearings  
Scorrevole con 2 cuscinetti

**ART. 871/C.S.**  
S.871/C.S.-NK

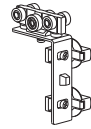

Slide with 6 bearings  
Scorrevole con 6 cuscinetti

**ART. 872**  
S.1321.3

## MEASUREMENTS DESCRIPTION / DESCRIZIONE MISURE

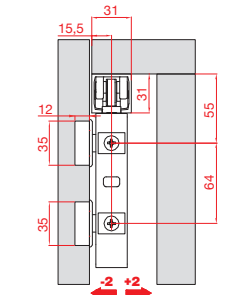
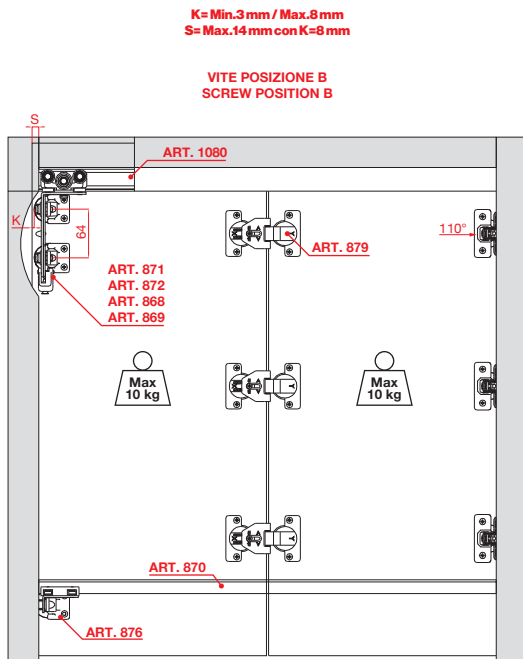

**ART. 871/C.S. (S.871/C.S.-NK)**  
**ART. 872 (S.1321.3)**

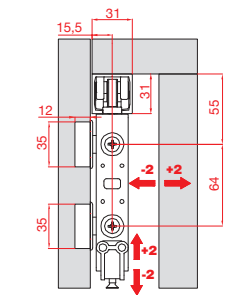

**ART. 868/C.S. (S.868/C.S.-NK)**  
**ART. 869 (S.1321.2)**

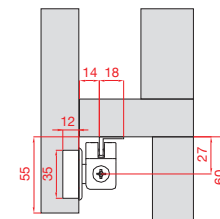

**ART. 876 (S.876-NK)**

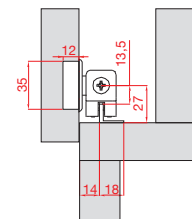

**ART. 875 (S.875-NK)**

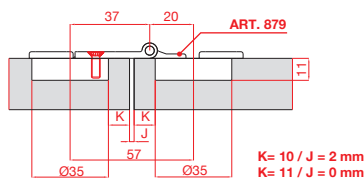





# Zig Zag Wardrobe

Sliding systems for wardrobe folding doors  
Sistemi di scorrimento per ante a libro per armadi

## SYSTEM FOR SINGLE FREE FOLDING DOORS SISTEMA PER ANTA A LIBRO SINGOLA LIBERA



Biextended anti-dust profile  
Profilo biestroso parapolvere

**ART. 892**  
8 23 0.00892

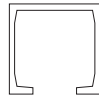

Aluminium track  
Binario in alluminio

**ART. 1080**  
8 00 0.01080  
8 01 0.01080



One-hinge slider  
Scorrevole con una cerniera

**ART. 870**  
8 00 0.00870  
8 01 0.00870

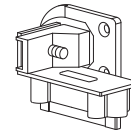

**ART. 875**  
S.875-NK

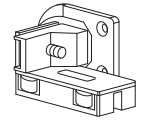

**ART. 876**  
S.876-NK

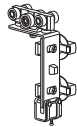

Adjustable slide with 6 bearings  
Scorrevole regolabile con 6 cuscinetti

**ART. 869**  
S.1321.2

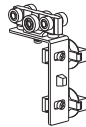

slide with 6 bearings  
Scorrevole con 6 cuscinetti

**ART. 872**  
S.1321.3

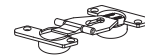

Hinge  
Cerniera

**ART. 879**  
S.1322.4

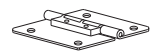

**ART. 883**  
S.883

## MEASUREMENTS DESCRIPTION / DESCRIZIONE MISURE

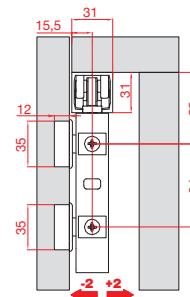
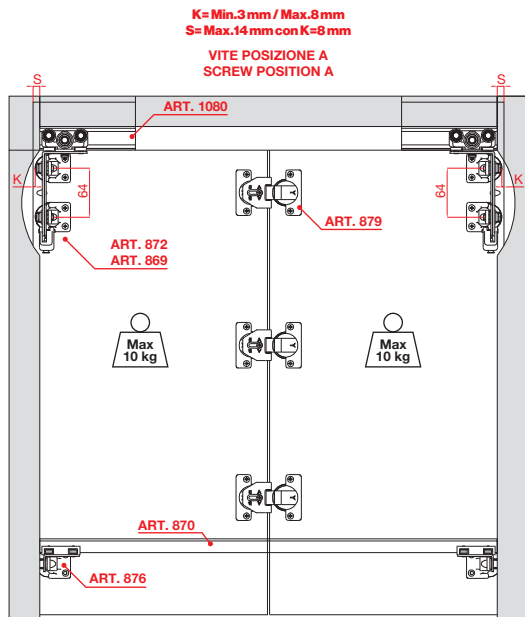

**ART. 872 (S.1321.3)**

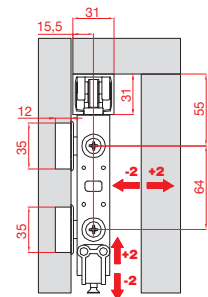

**ART. 869 (S.1321.2)**

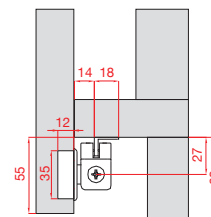

**ART. 876 (S.876-NK)**

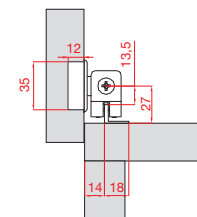

**ART. 875 (S.875-NK)**

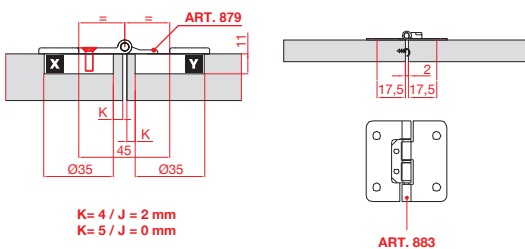

**ART. 883 (S.883)** can be used instead of **ART. 879 (S.1322.4)**.

Gli **ART. 883 (S.883)** si possono usare in alternativa agli **ART. 879 (S.1322.4)**.

**SYSTEM FOR SINGLE FREE FOLDING DOORS**  
**SISTEMA PER ANTA A LIBRO SINGOLA LIBERA**



Biextended anti-dust profile  
Profilo biestruo parapolvere

**ART. 892**  
8 23 0.00892

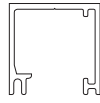

Aluminium track  
Binario in alluminio

**ART. 1081**  
8 00 0.01081  
8 01 0.01081

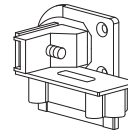

One-hinge slider  
Scorrevole con una cerniera

**ART. 875**  
S.875-NK

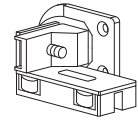

**ART. 876**  
S.876-NK



Plastic track  
Binario in plastica

**ART. 730**  
8 01 0.00730

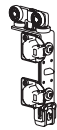

Adjustable slide with 6 bearings  
Scorrevole regolabile con 6 cuscinetti

**ART. 862**  
S.1321.1

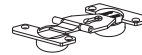

Hinge  
Cerniera

**ART. 879**  
S.1322.4

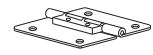

**ART. 883**  
S.883

**MEASUREMENTS DESCRIPTION / DESCRIZIONE MISURE**

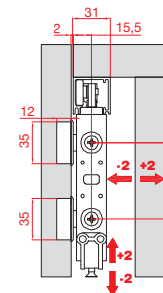
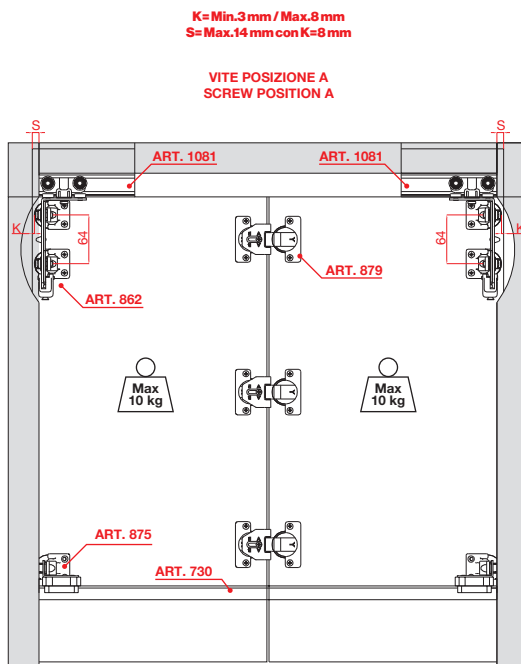

**ART. 862 ( S.1321.1 )**

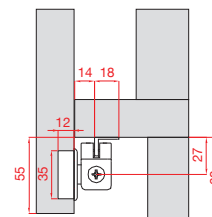

**ART. 876 ( S.876-NK )**

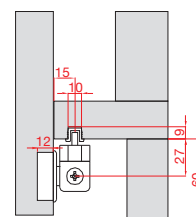

**ART. 875 ( S.875-NK )**

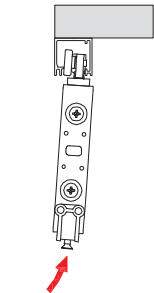

**ART. 883 ( S.883 )**

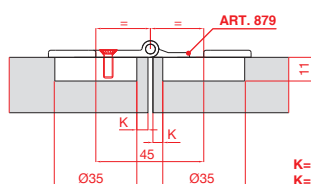

**K= 4 / J = 2 mm**  
**K= 5 / J = 0 mm**

**ART. 883 (S.883) can be used instead of ART. 879 (S.1322.4).**

Gli **ART. 883 (S.883)** si possono usare in alternativa agli **ART. 879 (S.1322.4)**.

**SYSTEM FOR MULTIPLE HINGED FOLDING DOORS**  
**SISTEMA PER ANTE A LIBRO MULTIPLE INCERNIERATE**



Biextended anti-dust profile  
Profilo biestruo parapolvere

**ART. 894**  
8 14 0.00894

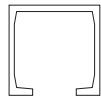

Aluminium track  
Binario in alluminio

**ART. 1080**  
8 00 0.01080  
8 01 0.01080



Aluminium track  
Binario in alluminio

**ART. 870**  
8 00 0.00870  
8 01 0.00870

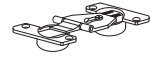

Hinge  
Cerniera

**ART. 879**  
S.1322.4

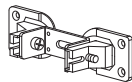

A two-hinged joint  
Giunzione con due cerniere

**ART. 874**  
S.874-NK

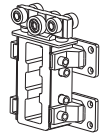

Four-hinge slider  
Scorrevole con quattro cerniere

**ART. 873**  
S.873-NK

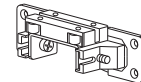

Double-hinge slider  
Scorrevole con due cerniere

**ART. 878**  
S.878-NK

**MEASUREMENTS DESCRIPTION / DESCRIZIONE MISURE**

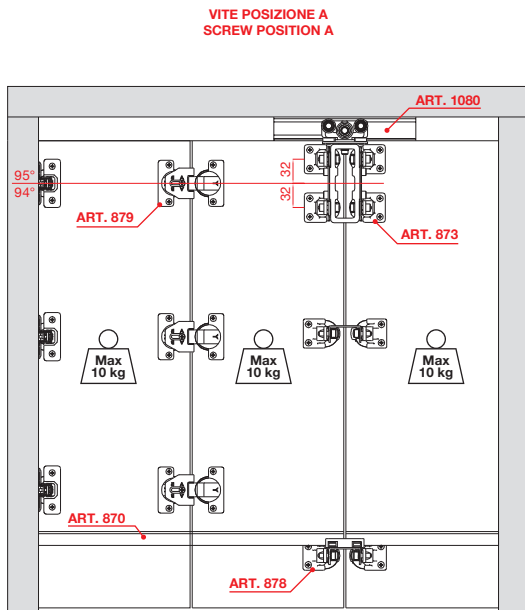

The weight of the doors must be supported mostly by the 94°-95° hinges.  
Il peso delle ante deve essere sostenuto maggiormente dalle cerniere 94°-95°.

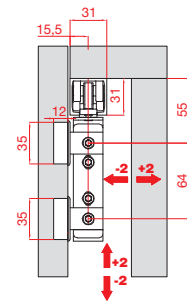

**ART. 873 (S.873-NK)**

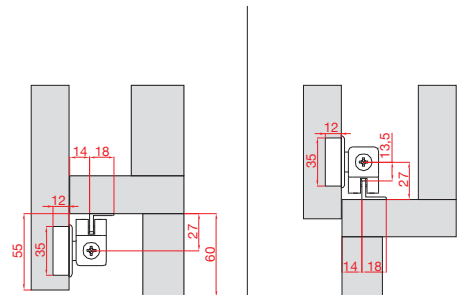

**ART. 878 (S.878-NK)**

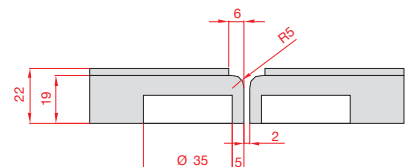
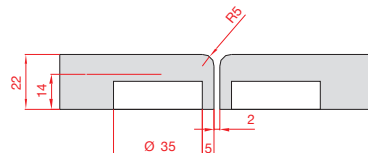
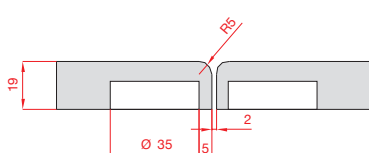

**ART. 873 (S.873-NK) / ART. 874 (S.874-NK) / ART. 878 (S.878-NK)**

## SYSTEM FOR MULTIPLE HINGED FOLDING DOORS SISTEMA PER ANTE A LIBRO MULTIPLE INCERNIERATE



Biextended anti-dust profile  
Profilo biestruo parapolvere

**ART. 894**  
**8 14 0.00894**

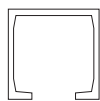

Aluminium track  
Binario in alluminio

**ART. 1080**  
**8 00 0.01080**  
**8 01 0.01080**



Plastic track  
Binario in plastica

**ART. 730**  
**8 01 0.00730**

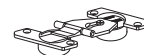

Hinge  
Cerniera

**ART. 879**  
**S.1322.4**

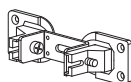

A two-hinged joint  
Giunzione con due cerniere

**ART. 874**  
**S.874-NK**

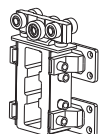

Four-hinge slider  
Scorrevole con quattro cerniere

**ART. 873**  
**S.873-NK**

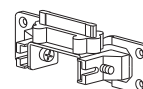

Double-hinge slider  
Scorrevole con due cerniere

**ART. 877**  
**S.877-NK**

## MEASUREMENTS DESCRIPTION / DESCRIZIONE MISURE

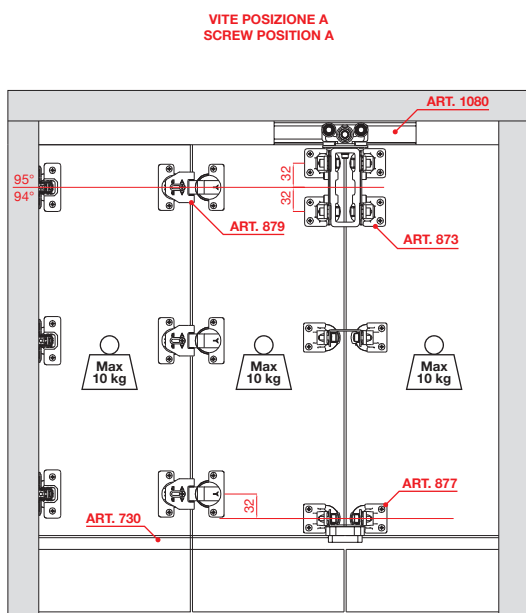

The weight of the doors must be supported mostly by the 94°-95° hinges.  
Il peso delle ante deve essere sostenuto maggiormente dalle cerniere 94°-95°.

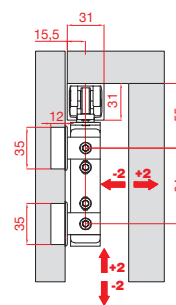

**ART. 873 (S.873-NK)**

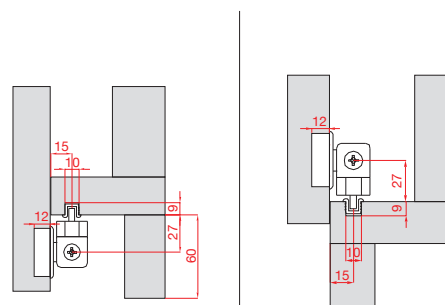

**ART. 877 (S.877-NK)**

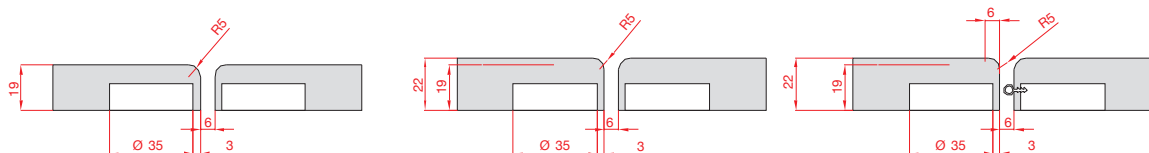

**ART. 873 (S.873-NK) / ART. 874 (S.874-NK) / ART. 877 (S.877-NK)**

## SYSTEM FOR MULTIPLE HINGED FOLDING DOORS SISTEMA PER ANTE A LIBRO MULTIPLE INCERNIERATE



Biextended anti-dust profile  
Profilo biestruo parapolvere

**ART. 894**  
8 14 0.00894

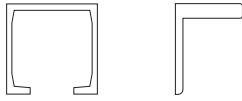

Aluminium track  
Binario in alluminio

**ART. 1080**      **ART. 870**  
8 00 0.01080      8 00 0.00870  
8 01 0.01080      8 01 0.00870

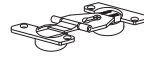

Hinge  
Cerniera

**ART. 879**  
S.1322.4

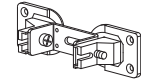

Joint with 2 hinges without spring  
Giunzione con 2 cerniere senza molla

**ART. 874**  
S.874-NK

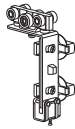

Adjustable slide with 6 bearings  
Scorrevole regolabile con 6 cuscinetti

**ART. 869**  
S.1321.2

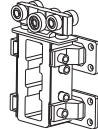

Four-hinge slider  
Scorrevole con 4 cerniere

**ART. 873**  
S.873-NK

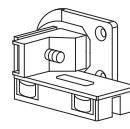

One-hinge slider  
Scorrevole con 1 cerniera

**ART. 876**  
S.876-NK

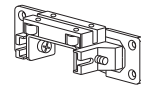

Double-hinge slider  
Scorrevole con 2 cerniere

**ART. 878**  
S.878-NK

## MEASUREMENTS DESCRIPTION / DESCRIZIONE MISURE

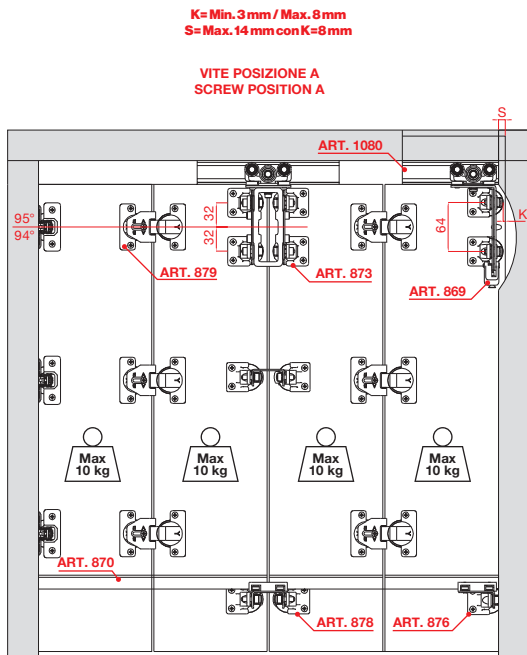

The weight of the doors must be supported mostly by the 94°-95° hinges .  
Il peso delle ante deve essere sostenuto maggiormente dalle cerniere 94°-95°.

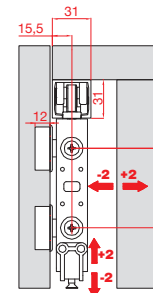
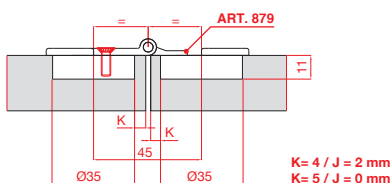

**ART. 869 ( S.1321.2 )**

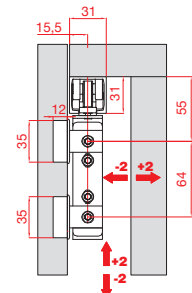

**ART. 873 ( S.873-NK )**

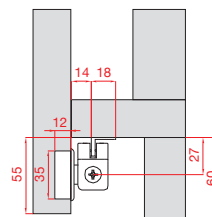

**ART. 876 ( S.876-NK )**

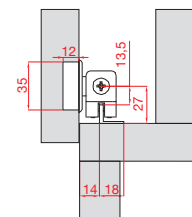

**ART. 878 ( S.878-NK )**

## SYSTEM FOR MULTIPLE HINGED FOLDING DOORS SISTEMA PER ANTE A LIBRO MULTIPLE INCERNIERATE



Biextended anti-dust profile  
Profilo biesteso parapolvere

**ART. 894**  
8 14 0.00894

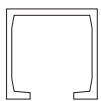

Aluminium track  
Binario in alluminio

**ART. 1080**  
8 00 0.01080  
8 01 0.01080



Plastic track  
Binario in plastica

**ART. 730**  
8 01 0.00730

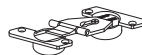

Hinge  
Cerniera

**ART. 879**  
S.1322.4

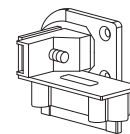

One-hinge slider  
Scivolante con 1 cerniera

**ART. 875**  
S.875-NK

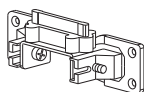

Double-hinge slider  
Scivolante con 2 cerniere

**ART. 877**  
S.877-NK

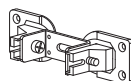

Joint with 2 hinges without spring  
Giunzione con 2 cerniere

**ART. 874**  
S.874-NK

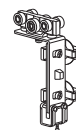

Adjustable slide with 6 bearings  
Scorrevole regolabile con 6 cuscinetti

**ART. 869**  
S.1321.2

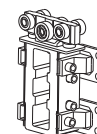

Four-hinge slider  
Scorrevole con 4 cerniere

**ART. 873**  
S.873-NK



## MEASUREMENTS DESCRIPTION / DESCRIZIONE MISURE

K= Min. 3 mm / Max. 8 mm  
S= Max. 14 mm con K= 8 mm

VITE POSIZIONE A  
SCREW POSITION A

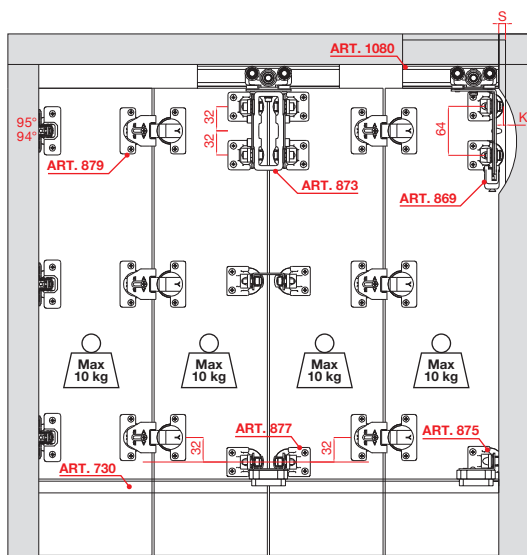

The weight of the doors must be supported mostly by the 94°-95° hinges.  
Il peso delle ante deve essere sostenuto Maggiormente dalle cerniere 94°-95°.

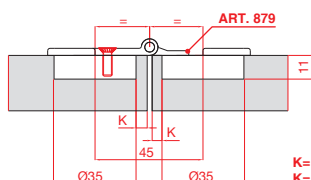

K= 4 / J = 2 mm  
K= 5 / J = 0 mm

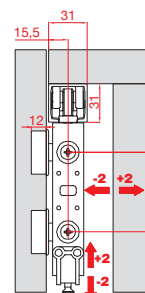

**ART. 869 (S.1321.2)**

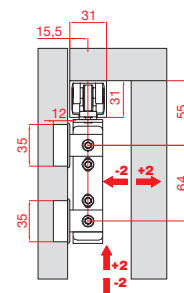

**ART. 873 (S.873-NK)**

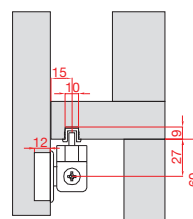

**ART. 875 (S.875-NK)**

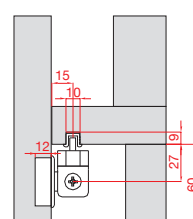

**ART. 877 (S.877-NK)**

# Zig Zag Wardrobe

Sliding systems for wardrobe folding doors  
Sistemi di scorrimento per ante a libro per armadi

## SYSTEM FOR MULTIPLE FOLDING DOORS SISTEMA PER ANTE A LIBRO MULTIPLE LIBERE



Biextended anti-dust profile  
Profilo biestruo parapolvere

**ART. 894**  
8 14 0.00894



Aluminium track  
Binario in alluminio

**ART. 1080**  
8 00 0.01080  
8 01 0.01080

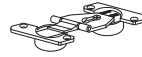

Hinge  
Cerniera

**ART. 879**  
S.1322.4

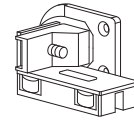

One-hinge slider  
Scivolante con 1 cerniera

**ART. 876**  
S.876-NK

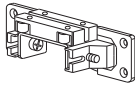

Double-hinge slider  
Scorrevole con 2 cerniere

**ART. 878**  
S.878-NK

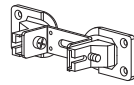

Joint with 2 hinges without spring  
Giunzione con 2 cerniere

**ART. 874**  
S.874-NK

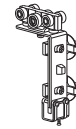

Adjustable slide with 6 bearings  
Scorrevole regolabile con 6 cuscinetti

**ART. 869**  
S.1321.2

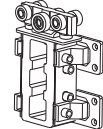

Four-hinge slider  
Scorrevole con 4 cerniere

**ART. 873**  
S.873-NK

## MEASUREMENTS DESCRIPTION / DESCRIZIONE MISURE

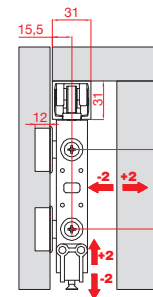
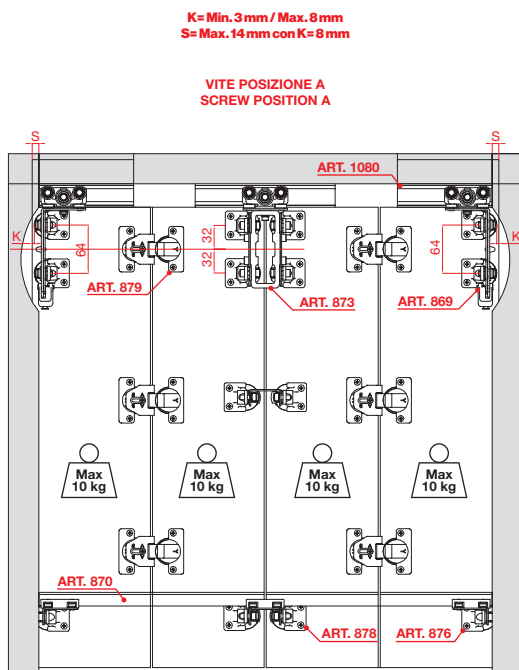

**ART. 869 (S.1321.2)**

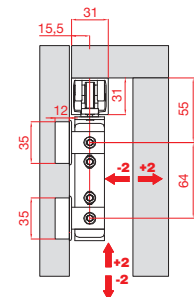

**ART. 873 (S.873-NK)**

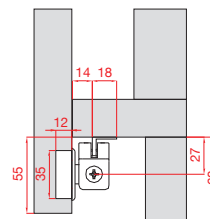

**ART. 876 (S.876-NK)**

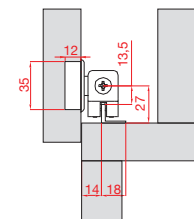

**ART. 878 (S.878-NK)**

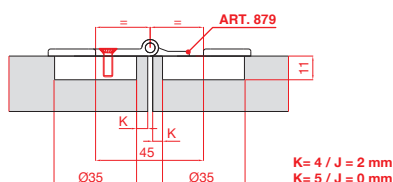



**SYSTEM FOR MULTIPLE FOLDING DOORS**  
**SISTEMA PER ANTE A LIBRO MULTIPLE LIBERE**



Biextended anti-dust profile  
 Profilo biesteso parapolvere

**ART. 894**  
**8 14 0.00894**

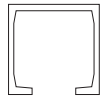

Aluminium track  
 Binario in alluminio

**ART. 1080**  
**8 00 0.01080**  
**8 01 0.01080**



Plastic track  
 Binario in plastica

**ART. 730**  
**8 01 0.00730**

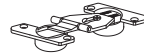

Hinge  
 Cerniera

**ART. 879**  
**S.1322.4**

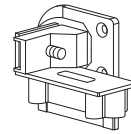

One-hinge slider  
 Scivolante con 1 cerniera

**ART. 875**  
**S.875-NK**

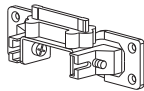

Double-hinge slider  
 Scivolante con 2 cerniere

**ART. 877**  
**S.877-NK**

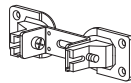

Joint with 2 hinges without spring  
 Giunzione con 2 cerniere

**ART. 874**  
**S.874-NK**

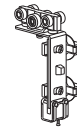

Adjustable slide with 6 bearings  
 Scorrevole regolabile con 6 cuscinetti

**ART. 869**  
**S.1321.2**

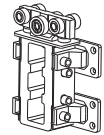

Four-hinge slider  
 Scorrevole con 4 cerniere

**ART. 873**  
**S.873-NK**

**MEASUREMENTS DESCRIPTION / DESCRIZIONE MISURE**

**K= Min. 3 mm / Max. 8 mm**  
**S= Max. 14 mm con K= 8 mm**

**VITE POSIZIONE A**  
**SCREW POSITION A**

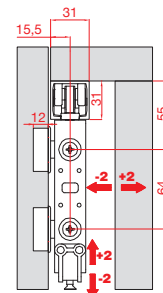
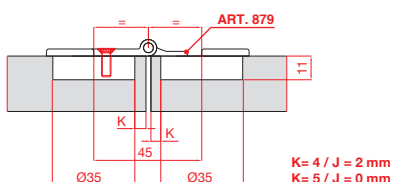
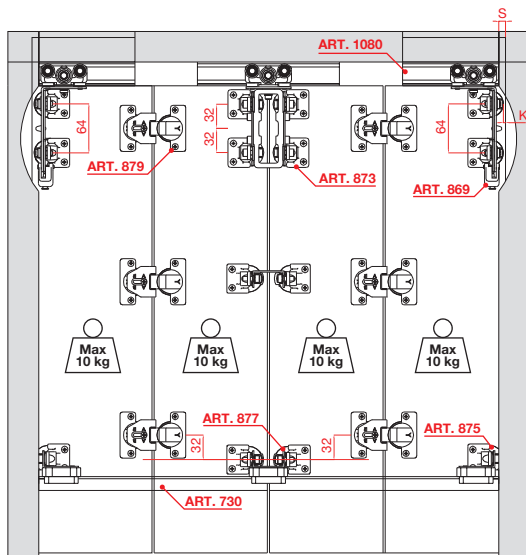

**ART. 869 ( S.1321.2 )**

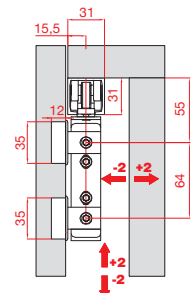

**ART. 873 ( S.873-NK )**

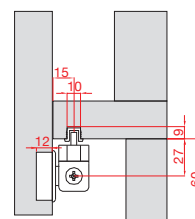

**ART. 875 ( S.875-NK )**

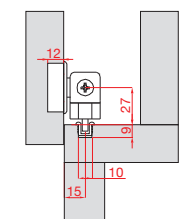

**ART. 877 ( S.877-NK )**



## **Terno Scorrevoli S.p.A.**

**Via Ravenna, 4 - 20814 Varedo (MB) ITALY**  
**Phone +39 0362 543001 - Fax +39 0362 582290**

**[terno@ternoscorrevoli.com](mailto:terno@ternoscorrevoli.com)**  
**[www.ternoscorrevoli.com](http://www.ternoscorrevoli.com)**