



Premier Accessories

Complementary accessories dedicated to wardrobes with external doors: straightening rods, handles and backer board joints
Accessori complementari per armadi con anta esterna: raddrizzanti, maniglioni e giunzioni per schienali



Aluminium handles / Maniglioni

MEASUREMENTS DESCRIPTION / DESCRIZIONE MISURE

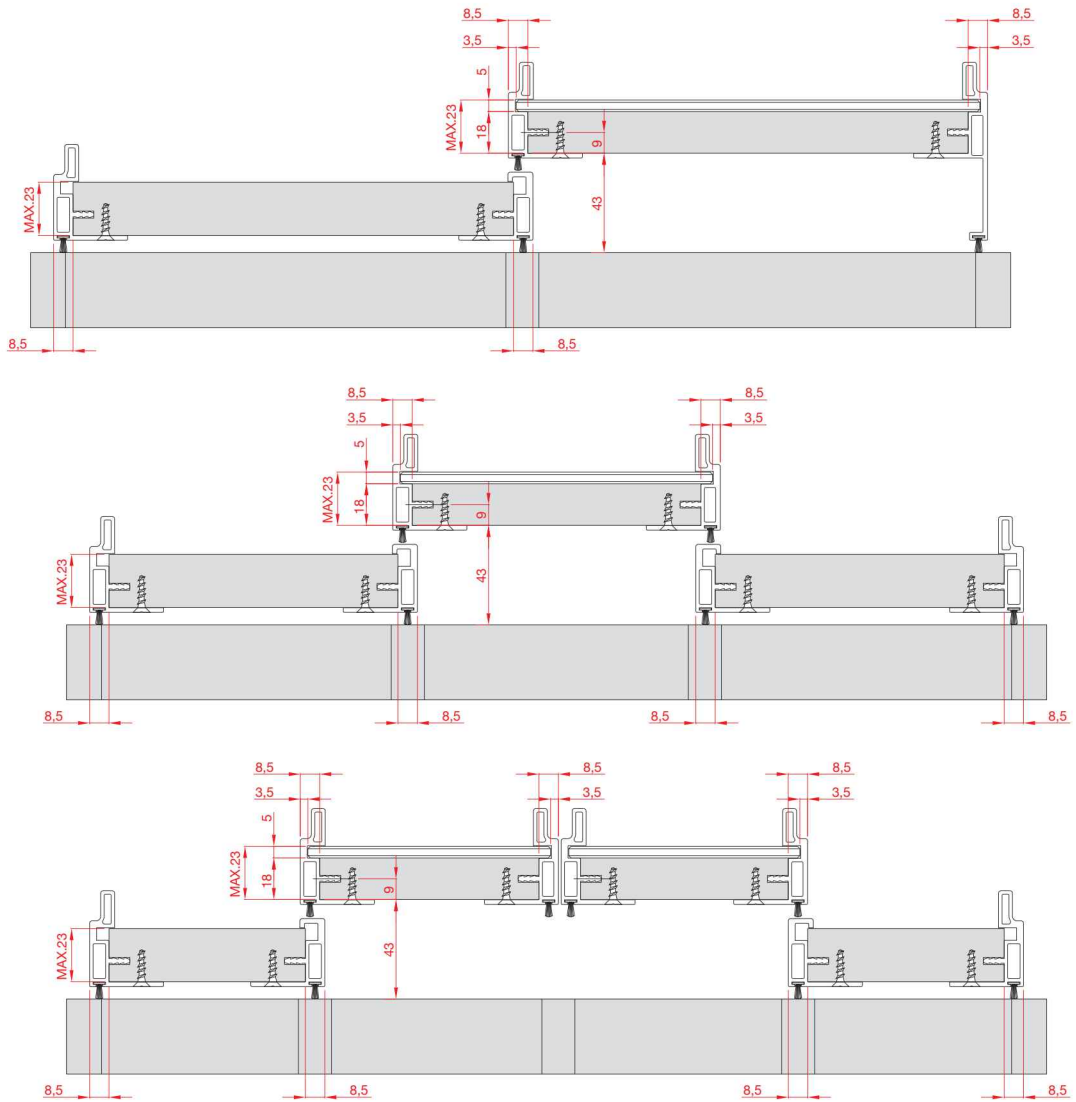

USE WITH 28 mm SLIDER KIT / UTILIZZARE CON KIT SCORREVOLI DA 28 mm

MEASUREMENTS DESCRIPTION / DESCRIZIONE MISURE

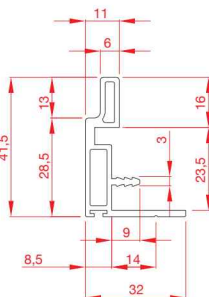

ART. 2212
8 02 2.02212

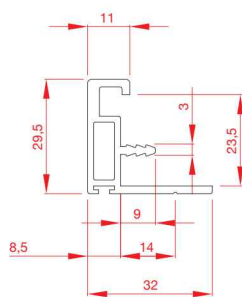

ART. 2210
8 02 2.02210

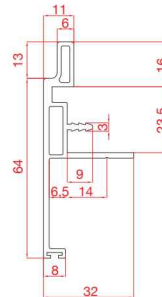



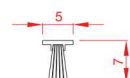



ART. 2214
8 02 2.02214

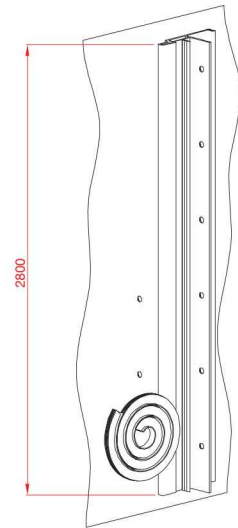
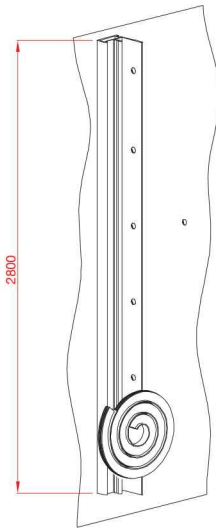
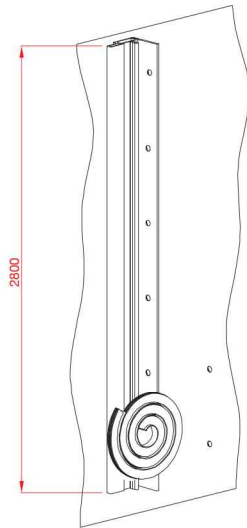

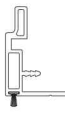
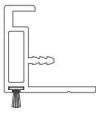
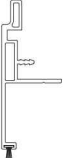
ART. 419
8 23 0.00419

Aluminium handles / Maniglioni



OLD CODE	NEW CODE	OLD CODE	NEW CODE	OLD CODE	NEW CODE
2222/AS/2800/FS	B.1141.3.02	2220/AS/2800/FS	B.1142.3.02	2224/AS/2800/FS	B.1143.3.02
 <p>ART. 2222 8 02 2 . 02222</p> <p>Handle for panel with dust brush Maniglia per pannello con spazzolino</p>		 <p>ART. 2220 8 02 2 . 02220</p> <p>Opposite handle for panel with dust brush Contromaniglia per pannello con spazzolino</p>		 <p>ART. 2224 8 02 2 . 02224</p> <p>Long handle for panel with dust brush Maniglia lunga per pannello con spazzolino</p>	
 <p>SCREW / VITI 3,5</p> <p>Use Ø3.5 wood screws Utilizzare viti per legno Ø3,5</p>		 <p>SCREW / VITI 3,5</p> <p>Use Ø3.5 wood screws Utilizzare viti per legno Ø3,5</p>		 <p>SCREW / VITI 3,5</p> <p>Use Ø3.5 wood screws Utilizzare viti per legno Ø3,5</p>	
 <p>ART. 419 8 23 0 . 00419</p> <p>Anti dust brush H=7 mm base 5 mm Spazzolino antipolvere H=7 mm base 5 mm</p>		 <p>ART. 419 8 23 0 . 00419</p> <p>Anti dust brush H=7 mm base 5 mm Spazzolino antipolvere H=7 mm base 5 mm</p>		 <p>ART. 419 8 23 0 . 00419</p> <p>Anti dust brush H=7 mm base 5 mm Spazzolino antipolvere H=7 mm base 5 mm</p>	

KIT COMPOSITION / COMPOSIZIONE KIT

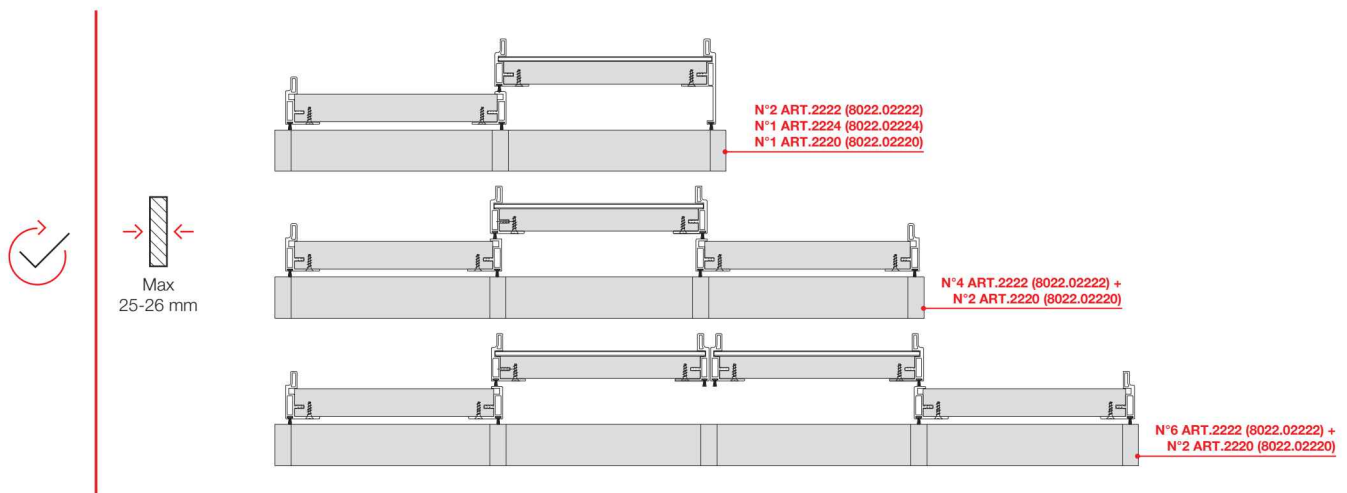

Tracks / Binari

ALUMINUM FINISHES CODES / CODICI FINITURE ALLUMINIO



CODE / CODICE	FINISH COLOR / COLORE FINITURA	STANDARD
8 02 0.0	02 AS Brushed Anodized Silver / Argento Spazzolato	STANDARD

Tracks / Binari

PLASTIC FINISHES CODES / CODICI FINITURE PLASTICA



CODE / CODICE	FINISH COLOR / COLORE FINITURA	STANDARD
8 23 0.0	23 GR Gray / Grigio	STANDARD