

Scheda tecnica del prodotto



Reggitubo centrale Equ

Reggitubi per tubi e di armadi

Specificazioni

L		Cod.	Finitura
30	500	8120325	Verniciato alluminio

Schema

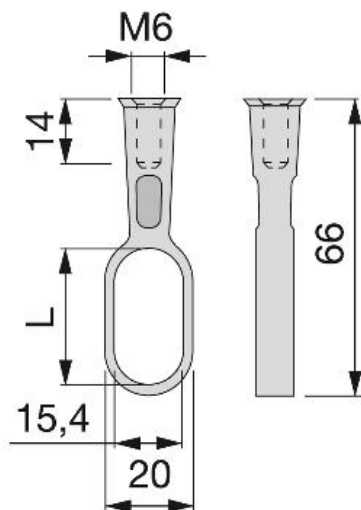

Prodotti fondamentali



Base Equ per reggitubo centrale



	Cod.	Finitura
500	8120425	Verniciato alluminio



Tubo alluminio Silk



		Cod.	Finitura
2,35 m	10	6072162	Anodizzato opaco
m	-	6072262	Anodizzato opaco



Tubo alluminio



		Cod.	Finitura
2,4 m	10	6220362	Anodizzato opaco
4 m	10	6220262	Anodizzato opaco
m	-	6219162	Anodizzato opaco

Tubo in acciaio



Altezza			Cod.	Finitura
30	2,4 m	10	7009411	Cromato brillo
30	3 m	10	7009911	Cromato brillo
30	m	-	8079011	Cromato brillo