

Sistemi di montaggio, viti e bussole / Sistemi di assemblaggio per mobili / Eccentrico T15 Ø15 / Tirante snodato

Scheda tecnica del prodotto



Tirante snodato

Eccentrico T15 Ø15

Specificazioni

	Cod.	Finitura
500	8044505	Zincato bianco

Schema

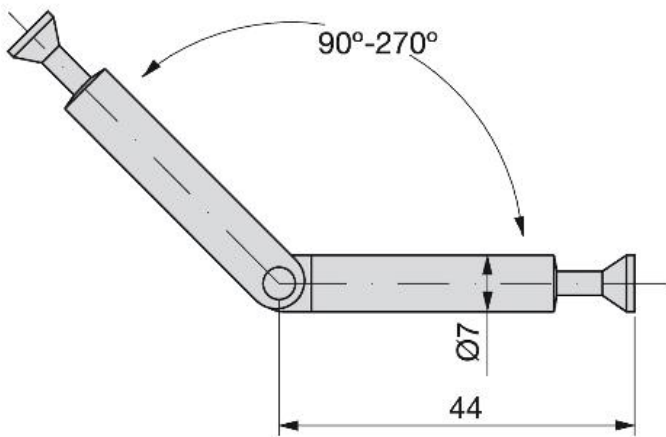

Informazioni

Fabbricato in acciaio tornito.

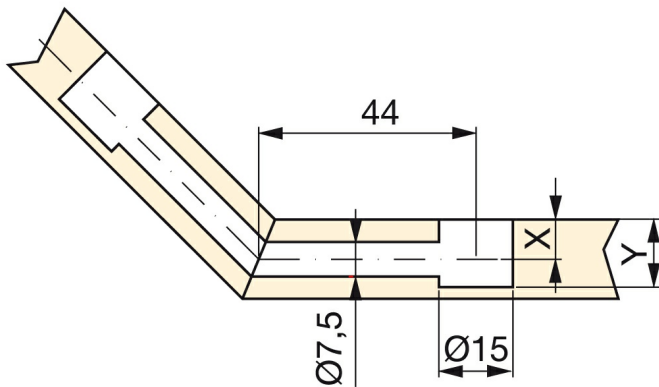

Montaggio



Prodotti fondamentali



Eccentrico



X	Y			Cod.	Finitura
6,5	11	13	2500	8005401	Zama grezza



Eccentrico rinforzato



X	Y			Cod.	Finitura
9,5	14	19	2500	8206905	Zincato bianco
9,5	14	19	2500	8206901	Zama grezza
12,5	17,5	25	1250	8006605	Zincato bianco

Eccentrico rinforzato con bordo



X	Y			Cod.	Finitura
9	14	18	1250	8007007	Nichelato
9	14	18	1250	8007005	Zincato bianco
12,5	17,5	25	1250	8006707	Nichelato

Tiranti ad anelli



A	Z	F		Cod.	Finitura
23	8	ITA 6MA	2500	5139805	Zincato bianco
23	9	Ø6	2500	5140005	Zincato bianco
27	8	ITA 6MA	2500	5139905	Zincato bianco
33	8	ITA 6MA	2500	5137705	Zincato bianco
33	11	Ø6	2500	5137605	Zincato bianco

Tirante pieno



A	Z	F		Cod.	Finitura
33	8	ITA 6MA	2500	5137905	Zincato bianco
33	11	Ø6	2500	5137805	Zincato bianco

Tirante con plastica



A	F	Z		Cod.	Finitura
33	11	Ø6	2500	5141305	Zincato bianco

Tirante Fit Ø8 ad espansione



A		Cod.	Finitura
21.6	2500	5912805	Zincato bianco
31.6	2500	5912905	Zincato bianco

Tirante doppio



A		Cod.	Finitura
16	500	5114505	Zincato bianco
19	500	5114605	Zincato bianco

Copriforo per vite a cono



	Cod.	Finitura
1250	9040717	Plastica nera
1250	9040716	Plastica noce
1250	9040715	Plastica bianca