



Scheda tecnica del prodotto



Boccia

Montaggio System Ø14

Specificazioni

X	Y	F			Cod.	Finitura
7	12	ITA 8MB	14	1000	8031205	Zincato bianco
8	14	ITA 8MB	16	1000	8010605	Zincato bianco
9	14.5	ITA 8MB	18	1000	4435105	Zincato bianco
9	14.5	ITA 8MB	18	1000	4435101	Zama grezza
9	14.5	ITA 8MA	18	1000	4417205	Zincato bianco
9	14.5	ITA 8MA	18	1000	4417201	Zama grezza
10	15.5	ITA 8MB	20	1000	8035005	Zincato bianco

Schema

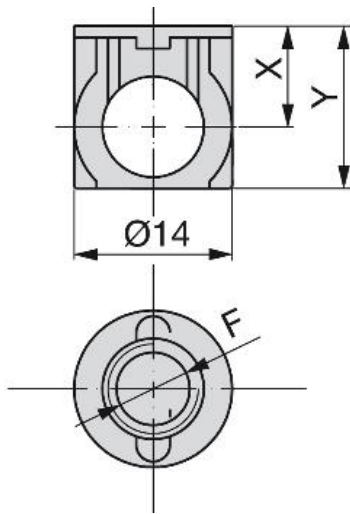

Montaggio

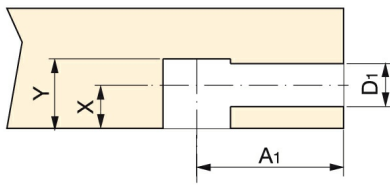
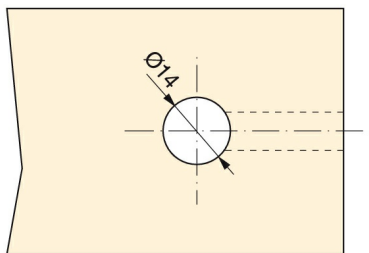

Tirante A	Fortura A ₁
18,5	20
20	21,5
28,5	30
30	31,1

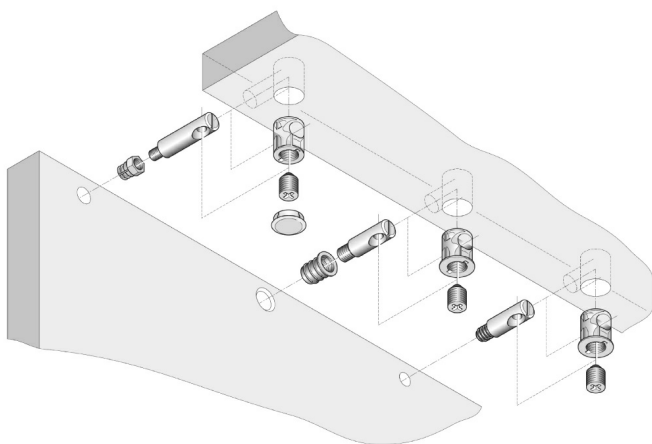

Tirante Ø	Fortura D ₁
7	Ø7,5
8	Ø8,5



Prodotti fondamentali



Boccola con collare



X	Y	F			Cod.	Finitura
9	14.5	ITA 8MB	18	1000	4434905	Zincato bianco
9	14.5	ITA 8MA	18	1000	4417005	Zincato bianco
12.5	18	ITA 8MA	25	1000	8008705	Zincato bianco



Viti a cono



X	F			Cod.	Finitura
8.5	ITA 8MB	14-16-18	1000	8146105	Zincato bianco
8.5	ITA 8MA	18	1000	8146205	Zincato bianco
10	ITA 8MB	20	1000	8111805	Zincato bianco
10	ITA 8MA	22	1000	8111905	Zincato bianco
12	ITA 8MA	25	1000	8112105	Zincato bianco

Viti a cono



X	F			Cod.	Finitura
10	ITA 8MA	18	1000	8069005	Zincato bianco

Tiranti



A	B	Z	Ø	F		Cod.	Finitura
18,5	26	9	7	bussola-m6	1000	8013005	Zincato bianco
20	27	9	7	bussola-m6	1000	8012905	Zincato bianco
28,5	36	9	7	bussola-m6	1000	8012805	Zincato bianco
30	36	9	7	bussola-m6	1000	8012705	Zincato bianco

Tirante doppio



	Cod.	Finitura
500	8410805	Zincato bianco

Copriforo per vite a cono



	Cod.	Finitura
1000	9071915	Plastica bianca

Copriforo per foro



	Cod.	Finitura
1000	9010715	Plastica bianca

Tirante ad angolo 90°



	Cod.	Finitura
250	8011705	Zincato bianco