

Accessori per cucina e il bagno / Piedini da cucina / Piede bone / Base con montaggio a vite

Scheda tecnica del prodotto



Base con montaggio a vite

Piede bone

CATAS®

Specificazioni

	Cod.	Finitura
200	3912117	Plastica nera

Schema

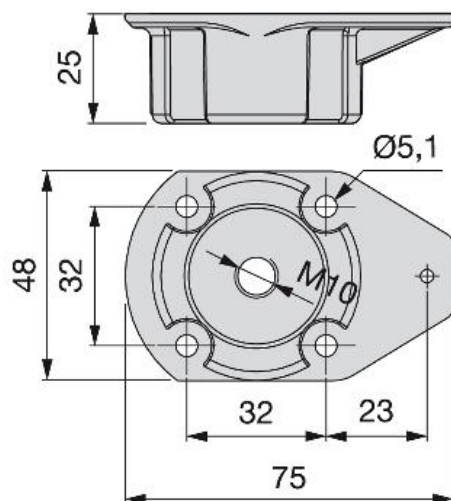

Informazioni

Piedino per moduli base da cucina.

Compatibile con zoccoli in alluminio e in legno mediante montaggio a vite o con fresata.

Confezionato a 4 pezzi in scatole da 200 pezzi.

Usare viti da Ø4 o Ø4,5 mm.

Prodotti fondamentali

Piede bone 60-80



Altezza Zoccolo	H		Cod.	Finitura
60	56 - 66	200	3911317	Plastica nera
80	74 - 84	200	3911417	Plastica nera



Piede bone 100-180



Altezza Zoccolo	H		Cod.	Finitura
100 - 120	98 - 140	200	3911817	Plastica nera
120 - 150	118 - 160	200	3911917	Plastica nera
150 - 165 - 180	148 - 190	200	3912017	Plastica nera

Base a montaggio diretto



	Ø		Cod.	Finitura
12	12.5	200	3912217	Plastica nera
13	13.5	200	3913217	Plastica nera
15	15.5	200	3913117	Plastica nera
16	16.5	200	3912417	Plastica nera

Pinza a montaggio diretto-vite



	Cod.	Finitura
200	3912917	Plastica nera

Pinza per zoccoli Line 2 e Plasline 2



	Cod.	Finitura
200	3913017	Plastica nera

Vite M10



	Cod.	Finitura
200	3912605	Zincato bianco