

MORSA+ MORSAADUE+



CERNIERE AD AGGANCIAMENTO RAPIDO
CON CONTROPIASTRE PREMONTATE

Solide
Veloci da montare
Resistenti

AV SAVIO



MORSA+ / MORSADUE+

Particolare della nuova contropiastra con l'innovativa dentellatura d'ancoraggio brevettata.

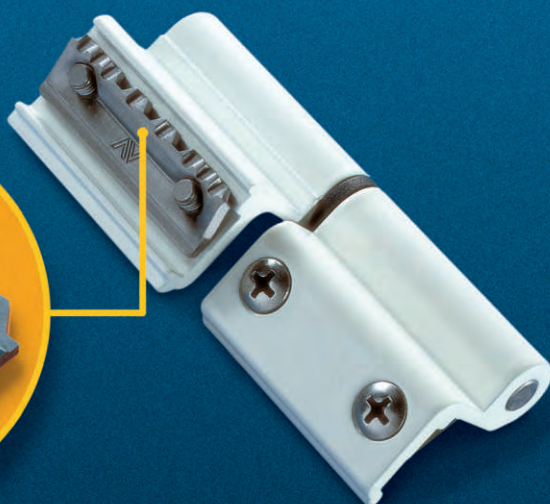
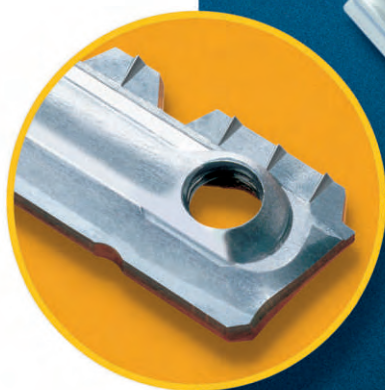

Per tenere a distanza le imitazioni...
MORSA HA TIRATO FUORI I DENTI!

Grazie all'esclusiva dentellatura d'ancoraggio, nessun'altra cerniera può garantire la stessa tenuta allo scorrimento!

► **PRIMA C'ERA MORSA...**

12 anni fa Savio brevettava MORSA rivoluzionando forma e contenuti della cerniera per serramenti e creando un nuovo standard operativo nel mercato.

► **MORSA+ e MORSADUE+, LA NUOVA RIVOLUZIONE**

La contropiastra di MORSA+ e di MORSADUE+ è stata arricchita di una dentellatura d'ancoraggio brevettata per garantire un fissaggio senza eguali.

MORSA+ e MORSADUE+: l'innovazione di SAVIO nelle cerniere per finestre

SISTEMA DI FISSAGGIO INNOVATIVO

La dentellatura in rialzo della contropiastra nella zona di inserimento all'interno del profilo ne incide la superficie impedendone lo scorrimento verticale.

VASTA GAMMA

La vasta gamma permette l'applicazione della cerniera su tutti i principali profili e per tutte le condizioni applicative.

PORTATA

La resistenza della cerniera consente di ottenere portate elevate che partono dagli 80 Kg con 2 cerniere a 2 ali (MORSA+) ed arrivano fino a 100 Kg con 3 cerniere a 3 ali.

MATERIALI

L'utilizzo della contropiastra insieme a viti e perno in acciaio inox consente l'applicazione della cerniera anche in ambienti corrosivi quali zone di mare, zone industriali ecc.

La boccia in bisolfuro di molibdeno riduce l'attrito tra i vari elementi impedendo così il verificarsi di fastidiosi rumori.

Cerniera ad aggancio rapido per finestre e porte finestre MORSA+

Impronta del giravite piu' profonda per permettere un serraggio anche con avvitatori elettrici o pneumatici. La forma svasata della testa aumenta la superficie di contatto sulla cerniera.

I fori di fissaggio sono asolati permettendo una autoregolazione della contropiastra per adattarsi alle normali tolleranze degli estrusi, massimizzando cosi' la presa sul profilo; il diametro della cerniera di 14 mm e lo spessore maggiorato degli altri componenti consente la massima portata della categoria.

Perno in acciaio inox di diametro 7mm, che piantato, tramite una zigrinatura, elimina tutte le tolleranze di accoppiamento e irrigidisce la cerniera.

Boccola al bisolfuro di molibdeno che garantisce una lunga durata senza attriti. Appositi anelli di centraggio distribuiti sulla circonferenza garantiscono un fissaggio solido all'interno dell'ala della cerniera.

Contropiastra in acciaio inox di spessore 2,3 mm., premontata, e' dotata nella zona di ancoraggio di un profilo sagomato che aumenta del 30% la superficie di presa sul profilo, e che, arricchito da una dentellatura incide il profilo bloccandone il posizionamento.

La speciale forma della contropiastra permette, serrando le viti, di portarla in tensione garantendo cosi' un fissaggio nel tempo. Una speciale bugnatura permette di aumentare la superficie filettata, della contropiastra per migliorarne l'avvitamento.

Cerniere per finestre



Art.	Descrizione	Pz.	Finiture
1121	(brevettato) Cerniera a 2 ali in alluminio, boccola in nylon, perno, contropiastre e 4 viti TSC M5x10 premontate in acciaio inox 430.	50	C, F, U, NE, BL10, B.SA, ZE, HL, 1013, 1015, 1247, 6002, 6005, 8017, 8019, 9001, 9005, 9006, 9010, 9016, 9660, BR4, BR801, BW21, GR217, GR50, GR51, GR606, RD501, WT005, PVD H, PVD X, XSD
1121.1	Versione rinnovata con nuova contropiastra dentellata. Portata:2 cerniere Kg 80, 3 cerniere Kg 90.	50	C, F, U, NE, BL10, B.SA, ZE, HL, 1013, 1015, 1247, 6002, 6005, 7032, 8017, 8019, 9001, 9005, 9006, 9010, 9016, 9660, BR4, BR801, BW21, GR217, GR50, GR51, GR606, RD501, WT005, PVD H, PVD X, XSD
1121.2/.5 1121.10/.13/.79	(finiture XSD, PVD H, PVD X: conf. da 20 pz.)	50	C, F, U, NE, BL10, ZE, HL, 1013, 6005, 8017, 8019, 9001, 9005, 9010, BR801, GR217, GR606, RD501, WT005
1121.3/.4/.7		50	C, F, U, NE, BL10, ZE, HL, 1013, 6005, 8017, 8019, 9001, 9005, 9010, BR801, GR50, GR51, GR217, GR606, RD501, WT005
1121.6		50	C, F, U, NE, BL10, ZE, HL, 1013, 6005, 8017, 8019, 9001, 9005, 9010, BR801, BW21, GR217, GR50, GR51, GR606, RD501, WT005
1121.9		50	C, F, U, NE, BL10, ZE, HL, 1013, 6005, 7032, 8017, 8019, 9001, 9005, 9010, BR801, BW21, GR217, GR50, GR51, GR606, RD501, WT005
1121.11		50	C, F, U, NE, BL10, ZE, HL, 1013, 3003, 6005, 7032, 8017, 8019, 9001, 9005, 9006, 9010, 9660, BR4, BR801, BW21, GR217, GR50, GR51, GR606, RD501, WT005, PVD H, PVD X, XSD
1121.12		50	C, F, U, NE, BL10, ZE, HL, 1013, 6005, 8017, 8019, 9001, 9005, 9010, 9660, BR4, BR801, GR217, GR606, RD501, WT005, XSD
1121.78		50	C, F, U, NE, BL10, ZE, HL, 1013, 6005, 8017, 8019, 9005, 9010, BR801, GR51, GR606, WT005
1121 D	Come 1121 ma preassemblata destra	50	F, NE, BL10, B.SA, ZE, 1013, 9005, 9010
1121 S	Come 1121 ma preassemblata sinistra	50	F, NE, BL10, B.SA, ZE, 1013, 9005, 9010
1121.1 D	Come 1121.1 ma preassemblata destra	50	F, NE, BL10, ZE, 1013, 7035, 8019, 9005, 9010
1121.1 S	Come 1121.1 ma preassemblata sinistra	50	F, NE, BL10, ZE, 1013, 7035, 8019, 9005, 9010
1121.11 D	Come 1121.11 ma preassemblata destra	50	F, NE, BL10, ZE, 1013, 9005, 9010
1121.11 S	Come 1121.11 ma preassemblata sinistra	50	F, NE, BL10, ZE, 1013, 9005, 9010



Art.	Descrizione	Pz.	Finiture
1121.951	Attrezzo piant. perno x art. 1121-1123	4	



Art.	Descrizione	Pz.	Finiture
1121.952	Attrezzo di piantaggio boccole per art. 1115-1116-1121-1123	4	

Cerniere per finestre



Art.	Descrizione	Pz.	Finiture
1122	(brevettato) Cerniera a 3 ali in alluminio premontata, boccole in nylon, perni, contropiastre e 6 viti TSC M5x10 premontate in acciaio inox 430.		C, F, U, NE, B.SA, BL10, ZE, HL, 1013, 1015, 6002, 6005, 8017, 8019, 9001, 9005, 9010, 9016, 9660, BR801, BW21, GR217, GR606, RD501, WT005
1122.1	Versione rinnovata con nuova contropiastra dentellata.		C, F, U, NE, BL10, ZE, HL, 1013, 6002, 6005, 8017, 8019, 9001, 9005, 9010, 9016, 9660, BR801, BW21, GR217, GR606, RD501, WT005
1122.2/.3/.4/.5 1122.7/.9/.10 1122.12/.13	Portata: 2 cerniere Kg 90, 3 cerniere Kg 100.		C, F, U, NE, BL10, ZE, HL, 1013, 6005, 8017, 8019, 9001, 9005, 9010, BR801, GR217, GR606, RD501, WT005
1122.6			C, F, U, NE, BL10, BW21, ZE, HL, 1013, 6005, 8017, 8019, 9001, 9005, 9010, BR801, GR217, GR606, RD501, WT005
1122.11			C, F, U, NE, BL10, ZE, HL, 1013, 6005, 7032, 8017, 8019, 9001, 9005, 9010, 9660, BR801, BW21, GR217, GR606, RD501, WT005



Art.	Descrizione	Pz.	Finiture
1122.200	(brevettato) Cerniera a pettine in alluminio premontata, boccole in nylon, perno sfilabile premontato , contropiastre e 6 viti TS M5x9 premontate in acciaio inox 430.	20	C, F, U, NE, B.SA, BL10, BW21, ZE, HL, 1013, 1015, 6005, 8017, 8019, 9001, 9005, 9006, 9010, 9016, 9660, BR801, GR217, GR606, RD501, WT005, PVD H, PVD X, XSD
1122.201	Portata: 2 cerniere Kg 90, 3 cerniere Kg 100. (finiture XSD, PVD H, PVD X: conf. da 10 pz.)	20	C, F, U, NE, BL10, BW21, ZE, HL, 1013, 1015, 6005, 7032, 8017, 8019, 9001, 9005, 9006, 9010, 9016, 9660, BR801, GR217, GR606, RD501, WT005, PVD H, PVD X, XSD
1122.211		20	C, F, U, NE, BL10, ZE, HL, 1013, 6005, 7032, 8017, 8019, 9001, 9005, 9010, 9016, BR801, GR217, GR606, RD501, WT005, PVD H, PVD X, XSD



Art.	Descrizione	Pz.	Finiture
1123	(brevettato) Cerniera a 2 ali per terza anta in alluminio, boccola in nylon, perno, contropiastre e 4 viti TSC M5x10 premontate in acciaio inox 430.	50	C, F, U, NE, B.SA, BL10, BW21, ZE, HL, 1013, 1015, 6005, 7032, 8017, 8019, 9001, 9005, 9006, 9010, 9016, 9660, BR4, BR801, GR217, GR50, GR51, GR606, RD501, WT005, PVD H, PVD X, XSD
1123.3/.5 1123.10/.13	Versione rinnovata con nuova contropiastra dentellata.	50	C, F, U, NE, BL10, ZE, HL, 1013, 6005, 8017, 8019, 9001, 9005, 9010, BR801, GR217, GR606, RD501, WT005
1123.6	Portata: 2 cerniere Kg 80, 3 cerniere Kg 90.	50	C, F, U, NE, BL10, BW21, ZE, HL, 1013, 6005, 8017, 8019, 9001, 9005, 9010, BR801, GR217, GR50, GR51, GR606, RD501, WT005
1123.9	(finiture XSD, PVD H, PVD X: conf. da 20 pz.)	50	C, F, U, NE, BL10, ZE, HL, 1013, 6005, 7032, 8017, 8019, 9001, 9005, 9010, BR801, BW21, GR217, GR606, RD501, WT005
1123.11		50	C, F, U, NE, BL10, ZE, HL, 1013, 3003, 6005, 7032, 8017, 8019, 9001, 9005, 9010, 9660, BR801, BW21, GR217, GR50, GR51, GR606, RD501, WT005, PVD H, PVD X, XSD
1123 D	Come 1123 ma preassemblata destra	50	NE, ZE, HL, 1013, 7035, 8019, 9005, 9006, 9010, XSD
1123 S	Come 1123 ma preassemblata sinistra	50	NE, ZE, HL, 1013, 7035, 8019, 9005, 9006, 9010, XSD

Cerniere per finestre



Art.	Descrizione	Pz.	Finiture
1115	(brevettato) Cerniera a 2 ali in alluminio, 2 boccole in nylon, perno in acciaio zincato, contropiastre e 4 viti TSC M5x10 premontate in acciaio inox 430.	50	C, F, U, NE, BL10, B.SA, ZE, HL, 1013, 1015, 1247, 6005, 8017, 8019, 9001, 9005, 9010, 9016, BR801, GR217, GR50, GR51, GR606, RD501, WT005
1115.1	Portata: 2 cerniere Kg 60, 3 cerniere Kg 70.	50	C, F, U, NE, BL10, ZE, HL, 1013, 6005, 8017, 8019, 9001, 9005, 9010, 9016, 9660, BR801, GR217, GR50, GR51, GR606, RD501, WT005
1115.3/.9/.13 1115.15/.115	Versione rinnovata con Ø maggiorato (ad eccezione di 1115.3/.9) e nuova contropiastra dentellata.	50	C, F, U, NE, BL10, ZE, HL, 1013, 6005, 8017, 8019, 9001, 9005, 9010, BR801, GR217, GR606, RD501, WT005
1115.11		50	C, F, U, NE, BL10, ZE, HL, 1013, 6005, 8017, 8019, 9001, 9005, 9010, 9660, BR801, GR217, GR606, RD501, WT005
1115.12/.71/.73		50	C, F, U, NE, BL10, ZE, HL, 1013, 6005, 8017, 8019, 9001, 9005, 9010, BR801, GR217, GR50, GR51, GR606, RD501, WT005
1115.14		50	C, F, U, NE, BL10, ZE, HL, 1013, 6005, 8017, 8019, 9001, 9005, 9010, BR4, BR801, GR217, GR606, RD501, WT005
1115.74/.75/.81 1115./83/.95	Come 1115 ma con perno in inox.	50	C, F, U, NE, BL10, ZE, HL, 1013, 6005, 8017, 8019, 9001, 9005, 9010, BR801, GR217, GR606, RD501, WT005



Art.	Descrizione	Pz.	Finiture
1116.1	(brevettato) Cerniera a 2 ali in alluminio per terza anta, 2 boccole in nylon, perno in acciaio zincato, contropiastre e 4 viti TSC M5x10 premontate in acciaio inox 430. Portata: 2 cerniere Kg 60, 3 cerniere Kg 70.	50	C, F, U, NE, BL10, ZE, HL, 1013, 1015, 6005, 8017, 8019, 9001, 9005, 9010, 9016, BR801, GR217, GR50, GR606, RD501, WT005
1116.3/.9 1116.11/.13/.15	Versione rinnovata con Ø maggiorato (ad eccezione di 1116.3/.9) e nuova contropiastra dentellata.	50	C, F, U, NE, BL10, ZE, HL, 1013, 6005, 8017, 8019, 9001, 9005, 9010, BR801, GR217, GR606, RD501, WT005
1116.75	Come 1116.1 ma con perno in inox.	50	C, F, U, NE, BL10, ZE, HL, 1013, 6005, 8017, 8019, 9001, 9005, 9010, BR801, GR217, GR606, RD501, WT005

Legenda finiture

1013 = verniciato avorio RAL
 1015 = verniciato avorio scuro RAL
 1247 = verniciato marrone scuro
 3003 = verniciato rosso RAL
 6002 = verniciato verde fogliame RAL
 6005 = verniciato verde muschio RAL
 7032 = verniciato grigio siliceo RAL
 7035 = verniciato grigio luce RAL
 8017 = verniciato marrone RAL
 8019 = verniciato caffè RAL
 9001 = verniciato crema RAL
 9005 = verniciato nero RAL

9006 = argento RAL verniciato a liquido
 9010 = verniciato bianco RAL
 9016 = verniciato bianco segnaletica RAL
 9660 = argento verniciato a polvere
 B.SA = verniciato bianco satinato
 BL10 = verniciato nero opaco
 BR 4 = verniciato liquido bronzo
 C = grezzo
 HL = oro lucido
 F = argento anodizzato
 U = bronzo anodizzato
 NE = nero elettrocolore

ZE = caffè elettrocolore
 BR801 = marrone marezzato
 BW21 = verniciato bianco ghiaccio
 GR217 = grigio scuro marezzato
 GR50 = verde grinz
 GR51 = marrone grinz
 GR606 = verde marezzato
 RD501 = rosso marezzato
 WT005 = bianco gotico
 PVD H = trattato PVD oro lucido
 PVD X = trattato PVD inox satinato
 XSD = inox satinato

Gamma cerniere serie 1115

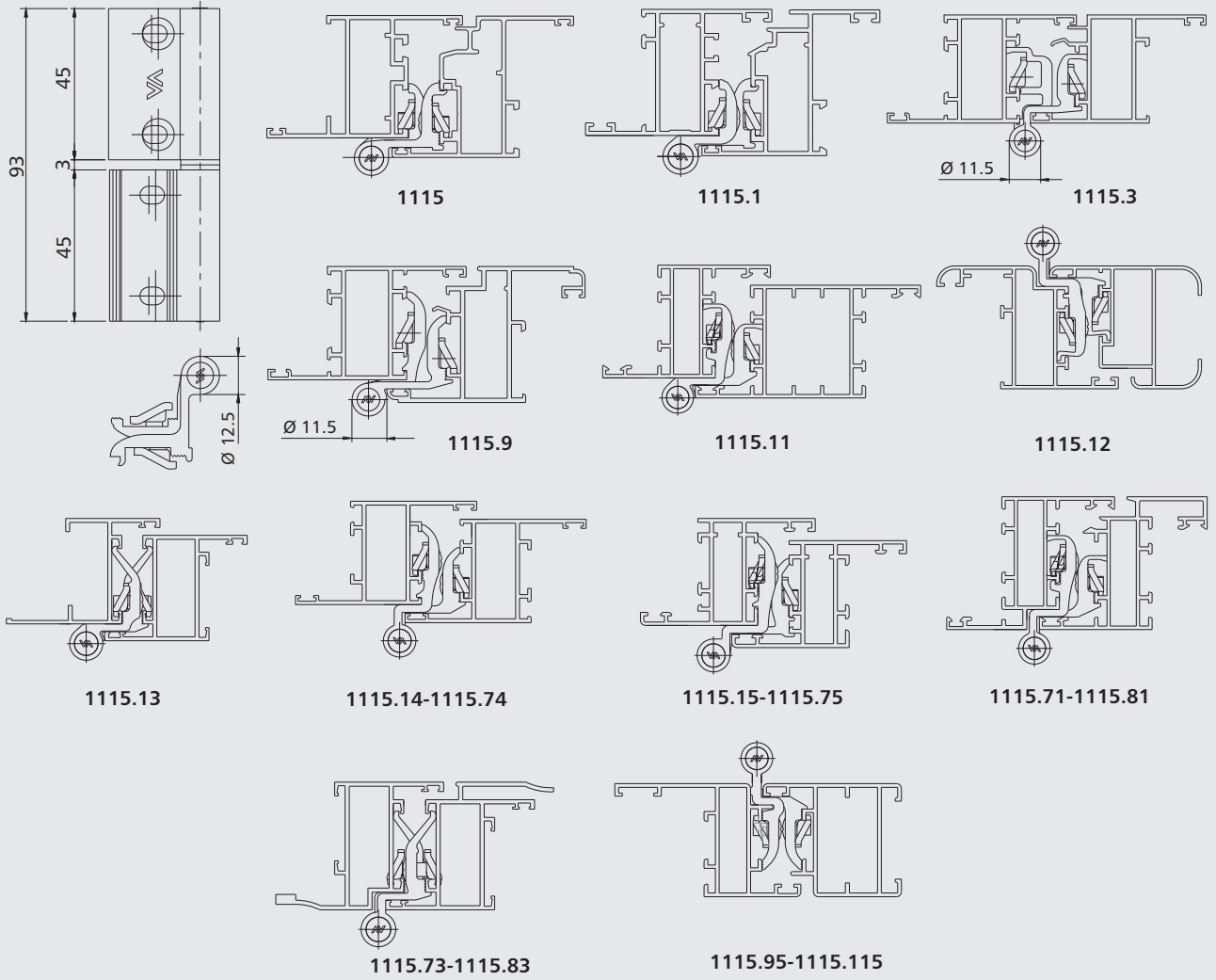

Gamma cerniere serie 1116

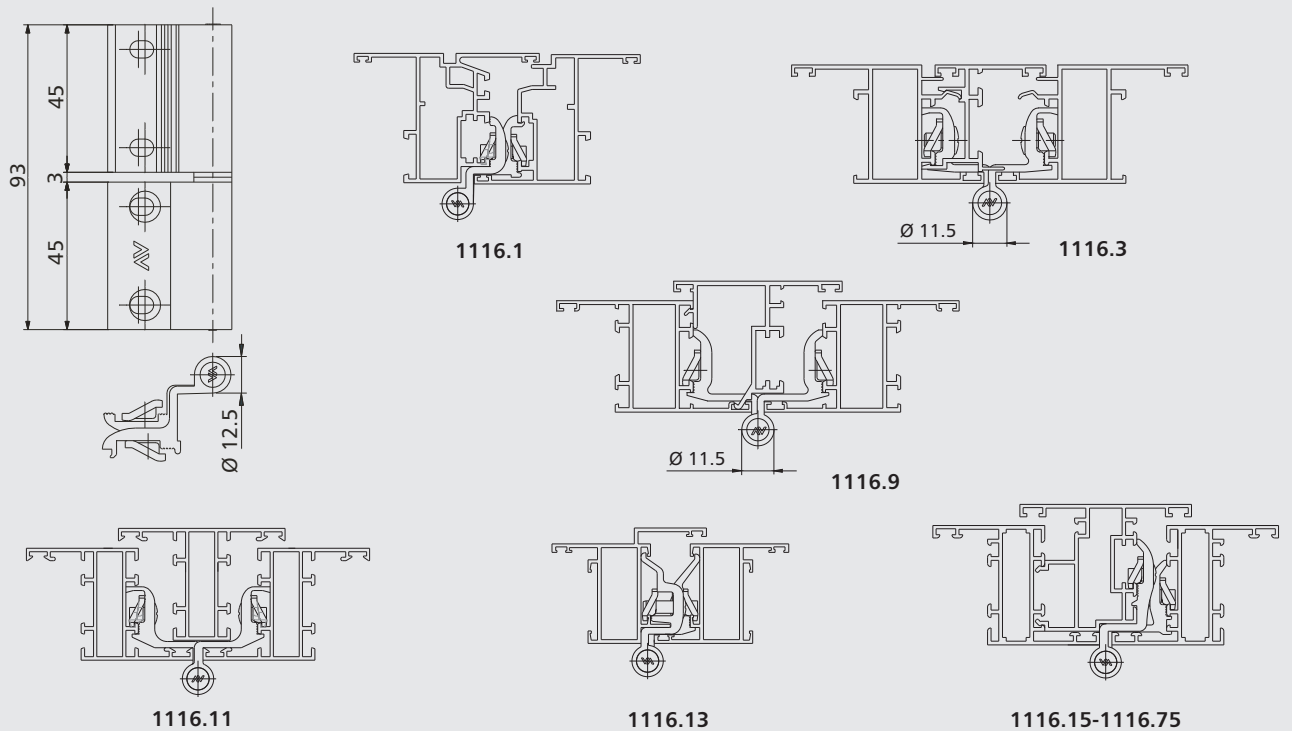

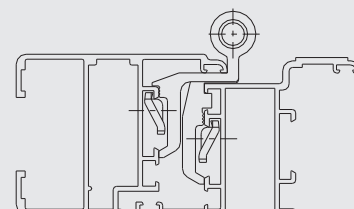
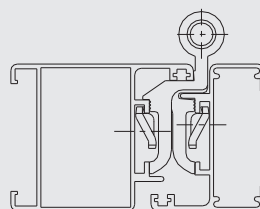
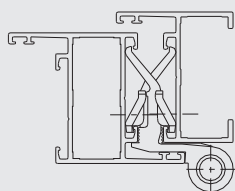
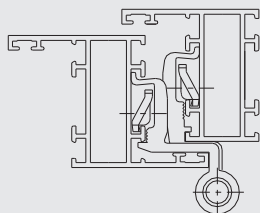
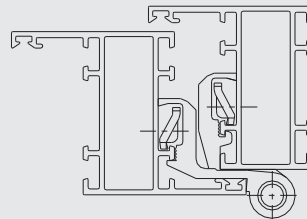
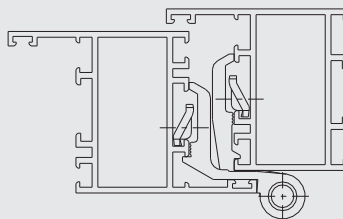
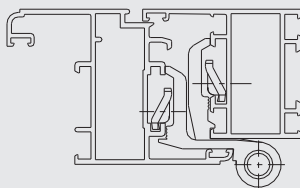
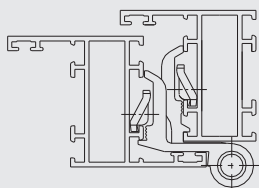
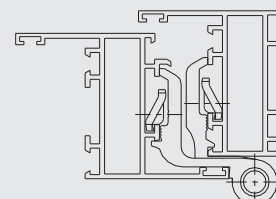
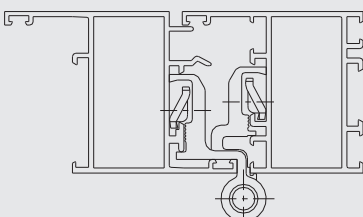
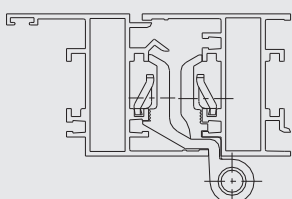
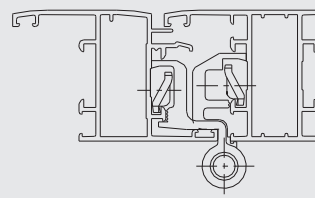
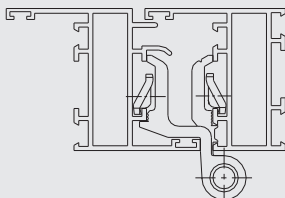
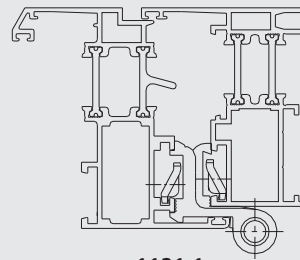
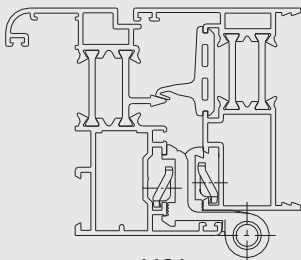
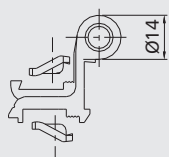
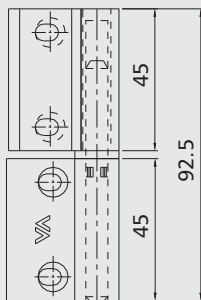

1121.951

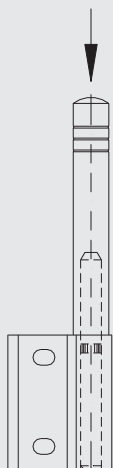

1121.952

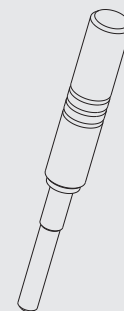
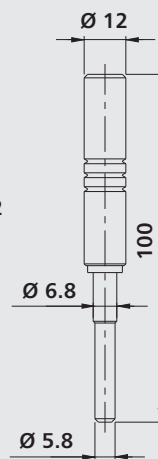

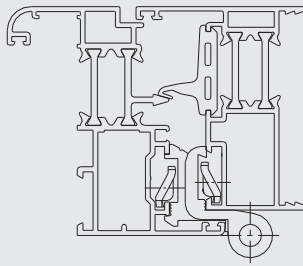
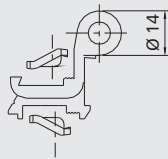
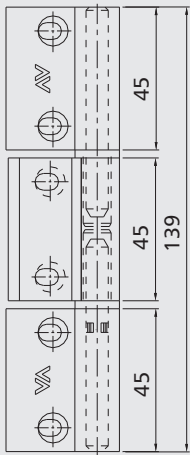

1122

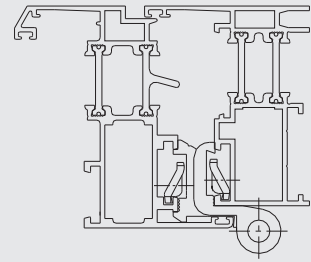

1122.1

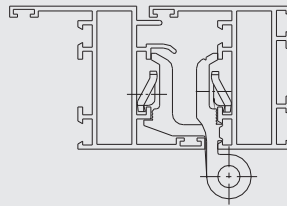

1122.2

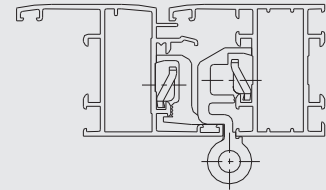

1122.3

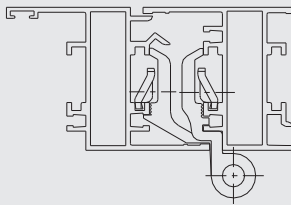

1122.4

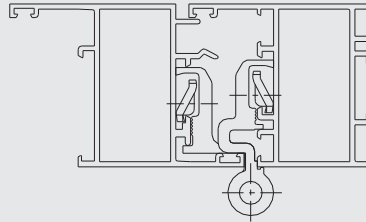

1122.5

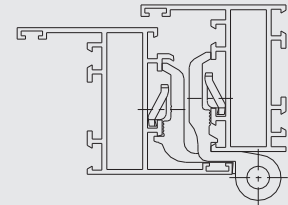

1122.6

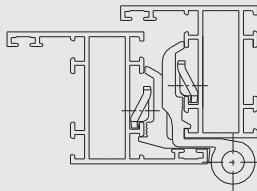

1122.7

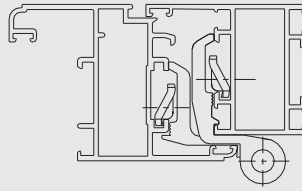

1122.9

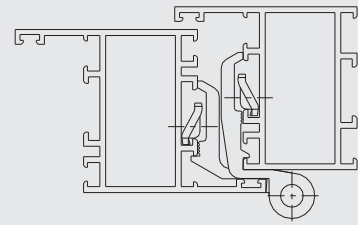

1122.10

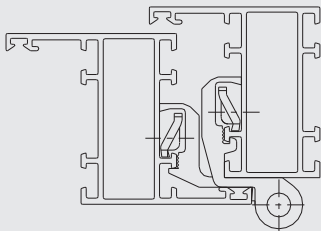

1122.11

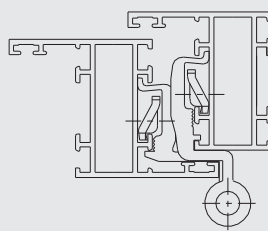

1122.12

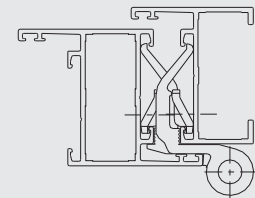

1122.13

Gamma cerniere a pettine

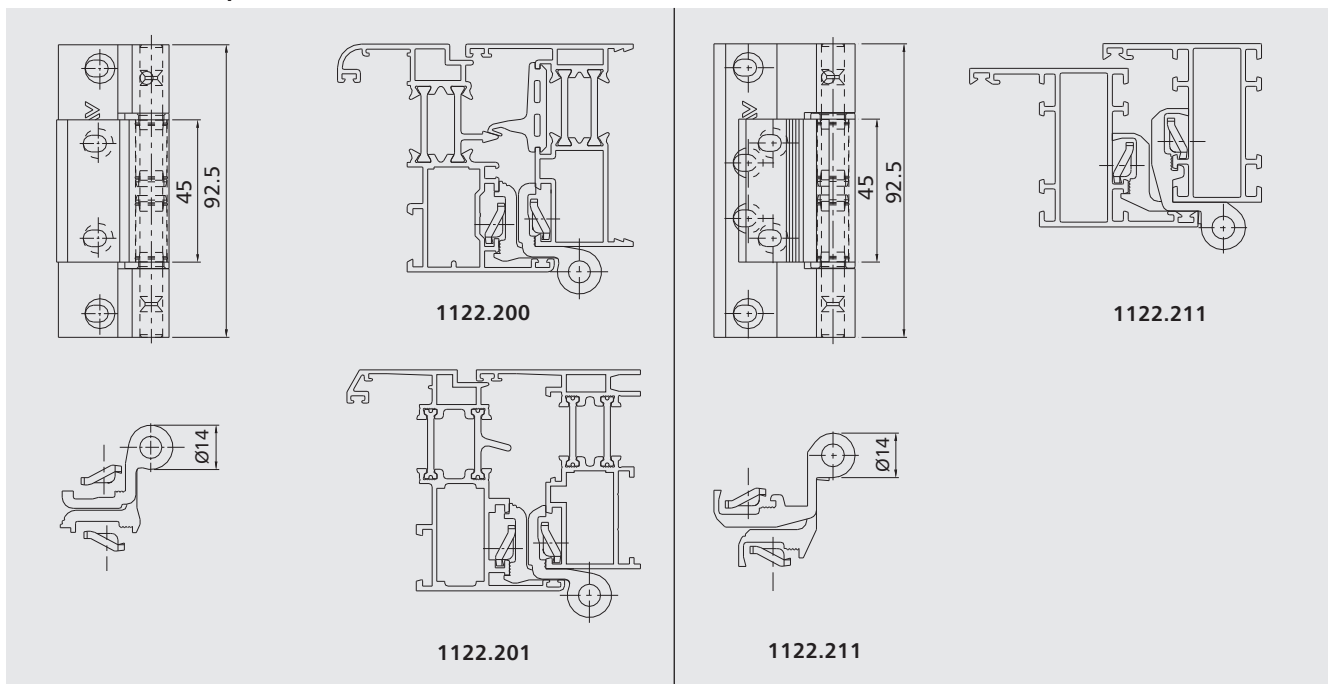

Gamma cerniere serie 1123



Tabella di adattabilità ai profili italiani

ESTRUSORE	PROFILO																											
		1115/1121/1121D/1121S/1122/1122.200	1115.1/1121.1/1122.1/1122.201	1115.11/1121.11/11D/11S/1122.11/1122.211/1123.11	1115.12/1121.12/1122.12	1115.13/1116.13	1115.14/74	1115.15/75-1116.15/75	1115.3/116.3/121.3/122.3/123.3	1115.7/81	1115.73/83	1115.9/116.9/121.9/122.9/123.9	1115.95/115	1116.1	1116.11	1121.2/1122.2	1121.4/1122.4	1121.5/1122.5/1123.5	1121.6/1122.6/1123.6	1121.7/1122.7	1121.10/1122.10/1123.10	1121.13/1122.13/1123.13	1121.78	1121.79	1123/1123D/1123S			
AL SYSTEM	GLOBAL 41																											
	GLOBAL 45																											
	GLOBAL 48																											
	GLOBAL 70 TT																											
ALCOA	R 40																											
	R 40 raggiato																											
	R 50																											
	R 50 TT																											
	R 50 TT barra cont.																											
	R 60 TT																											
	R 62 TT																											
R 72 TT																												
ALEXIA	ESEDRA GA 53																											
	ESEDRA GA 53 raggiato																											
	ESEDRA TT 63																											
	ESEDRA TT 75																											
ALL.CO	ALL.CO 5 complanare																											
	ALL.CO 5 sormonto																											
	ALL.CO 5 TT complanare																											
	ALL.CO 5 TT sormonto																											
	ALL.CO P 4 complanare																											
	ALL.CO P 4 sormonto																											
	ALL.CO P 4 sormonto raggiato																											
	EXPORT 40																											
	EXPORT 45																											
	EXPORT 45 persiana																											
	EXPORT 45 raggiato																											
	EXPORT 45 TT																											
	EXPORT 45 TT raggiato																											
	EXPORT 50																											
	EXPORT 50 TT																											
	K 40																											
	K 40 raggiato																											
	K 45T																											
	K 64T																											
	K 70T																											
NEW AGE																												
SICURBLIND 65 sormonto																												
ALMER	NC 50 l raggiato																											
ALUMEC	DS 45																											
	SYNTHESIS 45																											
	SYNTHESIS 57																											
	SYNTHESIS 60TT																											
ALUPEX	CRISTAL Porte																											
	EURO KEEPER 46/53																											
	GREEN 45 sormonto																											
	GREEN 45/52 SP.																											
	GREEN raggiato																											
	KEEPER 53/60																											
	KEEPER 53/60 raggiato																											
	KEEPER 61/68																											
POINT raggiato																												
POINT sormonto																												
BODEGA	BGA 50																											
	BGA 50 Arrotondato																											
	BGA 50 raggiato																											
	BT 60 TT																											
CLL	TECNO 50																											
	TECNO PERS. TC 12																											
	TECNO PERS. TC 40																											
	TECNO PERS. TC 45																											
	TECNO PERS. TC 50																											

ESTRUSORE	PROFILO																												
		1115/1121/1121D/1121S/1122/1122.200	1115.1/1121.1/1122.1/1122.201	1115.11/1121.11/11D/115/1122.11/1122.21/1123.11	1115.12/1121.12/1122.12	1115.13/1116.13	1115.14/74	1115.15/75-1116.15/75	1115.3/1116.3/1121.3/1122.3/1123.3	1115.71/81	1115.73/83	1115.9/1116.9/1121.9/1122.9/1123.9	1115.95/115	1116.1	1116.11	1121.2/1122.2	1121.4/1122.4	1121.5/1122.5/1123.5	1121.6/1122.6/1123.6	1121.7/1122.7	1121.10/1122.10/1123.10	1121.13/1122.13/1123.13	1121.78	1121.79	1123/1123D/1123S				
DEMAL	PRESTIGE 46																												
	PRESTIGE 48																												
EQUIPE	SERIE 8000		•																										
	SERIE 8000 Persiana																												
	SERIE 8000 raggiato																												
	SERIE 8000 TT		•																										
	SERIE 8000 TT raggiato																												
ETA	START 410		•																										
	START 410 PERSIANA		•																										
	START 410 raggiato																												
	START 470 TT		•																										
	START 470 TT raggiato																												
	START 510		•																										
	START 510 raggiato																												
	START 560 TT		•																										
	START 640 TT		•																										
	START 760 TT		•																										
FINAL	EXPORT 45		•																										
	EXPORT 45 raggiato																												
	EXPORT 45 T		•																										
	EXPORT 45 T raggiato																												
	EXPORT 50		•																										
EXPORT 50 T		•																											
HYDRO	BREAK PA 52		•																										
	BREAK PA 52 raggiato																												
	BREAK PA 62		•																										
	BREAK PA 63		•																										
	BREAK PA 70		•																										
	BREAK PA 70 S		•																										
	DOMAL 40				•																								
	DOMAL 40 raggiato																												
	DOMAL BRIGHT PA 70 S		•																										
	DOMAL BRIGHT PA 70 S raggiato																												
	DOMAL GELOSIA		•																										
	DOMAL INDOOR				•																								
	DOMAL STOPPER PG 63		•																										
	DOMAL SUNNY 40				•																								
	DOMAL SUNNY FIORENTINA				•																								
	DOMAL SUNNY PG																												
	DOMAL TWIN		•																										
	STOPPER PG		•																										
	STOPPER PG raggiato																												
STOPPER PG STYLE																													
IND.INVEST	ALPHA 445																												
	ALPHA 658 TT																												
	ALPHA GLOBO 45																												
	GOLD 400		•																										
	GOLD 400 raggiato																												
	GOLD 450		•																										
	GOLD 450 TT		•																										
	GOLD 490		•																										
	GOLD 500		•																										
	GOLD 500 raggiato																												
	GOLD 600		•																										
GOLDWING		•																											
ILLARY																													
KIKAU	K 80																												
	CLASSICA																												
METRA	FIRENZE																												
	METRALTECH		•																										
	NC 40 N sormonto				•																								
	NC 40 N sormonto raggiato				•																								
	NC 45 INT.		•																										
NC 45 INT. raggiato																													

Tabella di adattabilità ai profili italiani

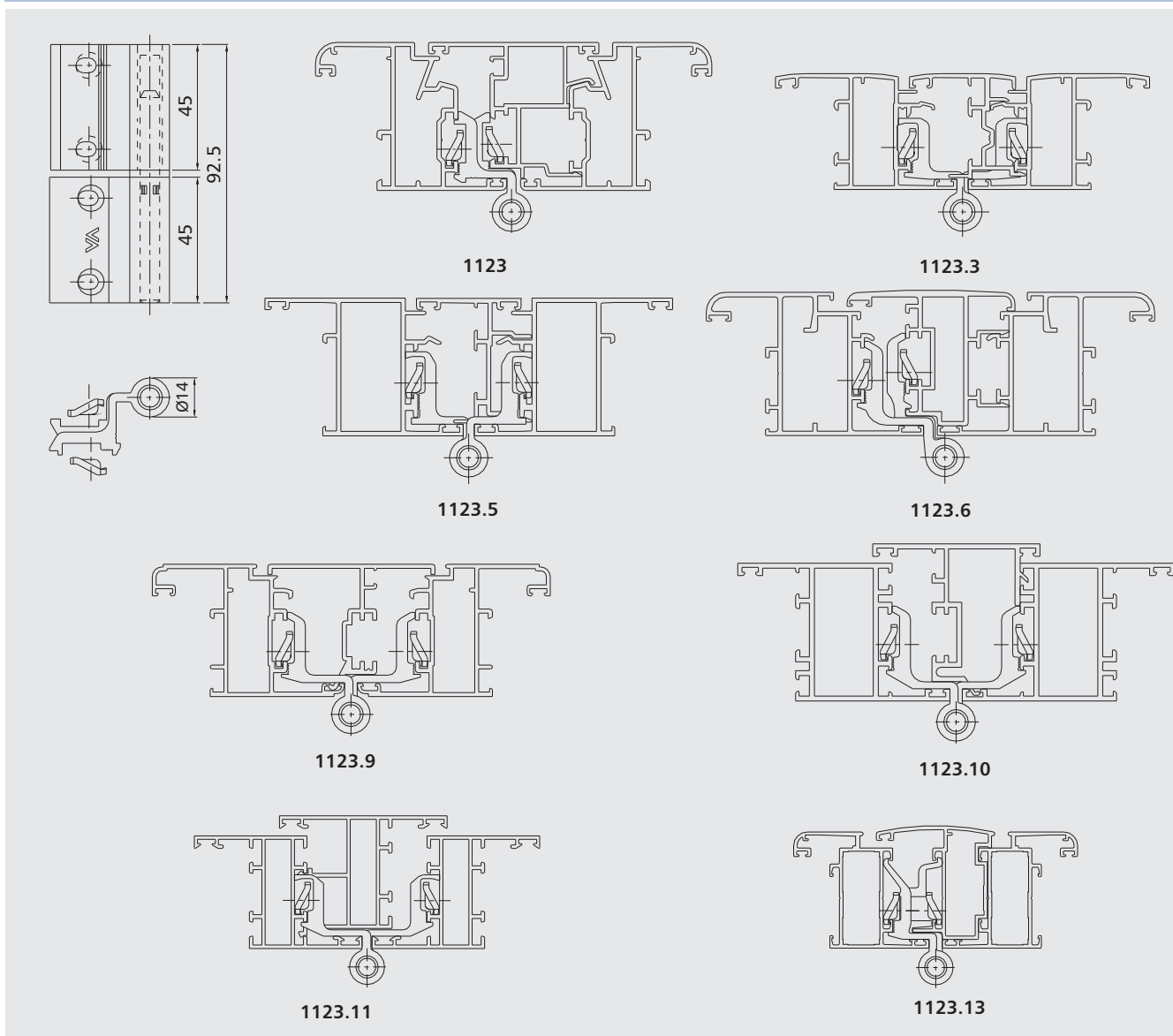
ESTRUSORE	PROFILO	Adattabilità ai profili italiani																										
		1115/1121/1121D/1121S/1122/1122.200	1115.1/1121.1/1122.1/1122.201	1115.11/1121.11/112D/115/1122.11/1122.211/1123.11	1115.12/1121.12/1122.12	1115.13/1116.13	1115.14/74	1115.15/75-1116.15/75	1115.3/1116.3/1121.3/1122.3/1123.3	1115.71/81	1115.73/83	1115.9/1116.9/1121.9/1122.9/1123.9	1115.95/115	1116.1	1116.11	1121.2/1122.2	1121.4/1122.4	1121.5/1122.5/1123.5	1121.6/1122.6/1123.6	1121.7/1122.7	1121.10/1122.10/1123.10	1121.13/1122.13/1123.13	1121.78	1121.79	1123/1123D/1123S			
METRA	NC 45 STH																											
	NC 50 I		•																									
	NC 50 I raggiato																											
	NC 50 STH																											
	NC 55 INT		•																									
	NC 65 STH		•																									
	NC 68 STH		•																									
	NC 68 STH.S		•																									
	NC 72 STH		•																									
	ORIENTABILE																											
	SCURETTO RUSTICO																											
SUPERBLINDO																												
TRIESTE																												
MEXALL	MX 50		•																									
	MX 70		•																									
MORELLI	MA 2000 TT		•																									
	MA 2000 TT raggiato																											
	MA 9600				•	•																						
	MA 9800																											
MA 9900				•	•																							
OCMA	SV 39		•																									
	SV 39/47 raggiato.																											
	SV 47/55		•																									
	SV TT55		•																									
	SV TT70		•																									
SV TT74		•																										
PASSERINI	EKIP 40 complanare																											
	EKIP 40 NUOVO complanare																											
	EKIP 40 NUOVO sormonto																											
	EKIP 40 sormonto																											
	EKIP 50 complanare																											
	EKIP 50 sormonto																											
	EKIP ev complanare																											
	EKIP ev sormonto																											
	EKIP THERMO 53																											
	MAASTRICHT 53		•																									
	MAASTRICHT LIGHT		•	•																								
	MAASTRICHT TH 60		•																									
	MAASTRICHT TH 68		•																									
VENICE TH16		•																										
PONZIO SUD	NEW TEC 50																											
	NEW TEC 50 CLASSIC																											
	NEW TEC 50 PERSIANE CON TELAIO																											
	NEW TEC 52 TT																											
	NEW TEC 52 TT CLASSIC																											
	NEW TEC 52 TT LIGHT																											
	NEW TEC 60 F																											
	NEW TEC 60 TT																											
	NEW TEC 68 TT																											
	WINDSTOP 45		•																									
	WINDSTOP 45 raggiato																											
	WINDSTOP 45 TT		•																									
	WINDSTOP 45 TT CLASSIC		•																									
	WINDSTOP 45 TT CLASSIC raggiato																											
	WINDSTOP 45 TT raggiato																											
	WINDSTOP 55 TT		•																									
	WINDSTOP 55 TT CLASSIC		•																									
	WINDSTOP 55 TT CLASSIC raggiato																											
	WINDSTOP 55 TT raggiato																											
	WINDSTOP 65 TT		•																									
WINDSTOP 65 TT CLASSIC		•																										
WINDSTOP 65 TT CLASSIC raggiato																												
WINDSTOP 65 TT raggiato																												

ESTRUSORE	PROFILO	PROFILATI
	1115/1121/1121D/11215/1122/1122.200	●
	1115.1/1121.1/1122.1/1122.201	
	1115.1/1121.11/11D/115/1122.11/1122.21/1123.11	
	1115.12/1121.12/1122.12	
	1115.13/1116.13	
	1115.14/74	
	1115.15/75-1116.15/75	
	1115.3/1116.3/1121.3/1122.3/1123.3	
	1115.71/81	
	1115.73/83	
	1115.9/1116.9/1121.9/1122.9/1123.9	
	1115.95/115	
	1116.1	●
	1116.11	
	1121.2/1122.2	
	1121.4/1122.4	
	1121.5/1122.5/1123.5	
	1121.6/1122.6/1123.6	
	1121.7/1122.7	
	1121.10/1122.10/1123.10	
	1121.13/1122.13/1123.13	
	1121.78	
	1121.79	
	1123/1123D/1123S	●
	EKU 40	●
	EKU 40 raggiato	
	EKU 53	●
	EKU 53 Persiana	●
	EKU 53 raggiato	
	EKU 53 TT	●
	EKU 53 TT raggiato	
	EKU 64 TT	●
	EKU 72 TT	●
	EKU KOMPACT	●
	PE 40	
	PE 40 raggiato	●
	PE 50	●
	PE 58 TT sormonto	●

La Savio S.p.A. si riserva la facoltà di modificare in qualsiasi momento e senza preavviso, le caratteristiche tecniche dei prodotti rappresentati nel presente catalogo.

Entra nel mondo SAVIO

www.savio.it

Cerca la qualità delle cerniere per finestre e porte finestre MORSAS+ e MORSADUE+ e di tutta la vasta produzione SAVIO sul sito istituzionale del gruppo. Scoprirai i vantaggi offerti da un portale aziendale in continua evoluzione per offrire i nuovi servizi agli operatori del mercato. Oltre alle informazioni a carattere istituzionale e le news sui prodotti, troverai una serie di servizi gratuiti mirati ai professionisti del settore, a tua disposizione semplicemente registrandoti e compilando l'apposito modulo online.

Così potrai ogni giorno e senza limiti d'orario:

- Consultare tutta la documentazione tecnica (cataloghi, brochure, istruzioni di montaggio, ecc.) e scaricarla in formato PDF
- Utilizzare il servizio di assistenza "Savio Web Assistance"
- Essere costantemente aggiornati via e-mail su tutte le novità del sito
- Conoscere in anteprima le offerte promozionali.



Aggiornarsi è facile: con www.savio.it basta un click!



- DIN EN ISO 14001
- Certified Management System
- DIN EN ISO 9001

Savio S.p.A. Via Torino, 25 (S.S. 25)
10050 Chiusa S. Michele (TO) Italy
Tel. +39.011.964.34.64 - Fax +39.011.964.34.74
www.savio.it - e-mail: savio@savio.it

SAVIO
Qualità e innovazione
per i serramenti