



PATENT PENDING

il movimento servetto va anche in orizzontale



made in Italy

MOTION-V

MOTION-V

design: **Ing.Emilio e Ezio Terragni**

In occasione del 40° anniversario del brevetto Servetto, l'azienda presenta un nuovo sistema brevettato di apertura e di chiusura applicabile ad ante di vario tipo, perfetta sintesi tra estetica e funzionalità.

Motion-V è un meccanismo rototraslante innovativo ed estremamente versatile, da utilizzare in qualsiasi ambiente.

Zum 40. Jubiläum des Patent Servetto, präsentiert die Firma ein neues patentiertes Öffnungs- und Schließungssystem, welches an verschiedenen Türen montiert werden kann, ein perfektes Zusammenspiel zwischen Ästhetik und Funktionalität.

Motion-V ist ein innovativer und extrem vielseitiger Schwenk-Mechanismus, einsetzbar in jedem Bereich.

Con ocasión del 40° aniversario de la patente de invención Servetto, la empresa presenta un nuevo sistema patentado de apertura y cierre aplicable a varios tipos de puertas, perfecta síntesis entre estética y funcionalidad.

Motion-V es un mecanismo de rototraslación innovador y muy versátil que se puede utilizar en cualquier ambiente.

On the occasion of the 40th anniversary of the patent Servetto, the company presents a new patented system of opening and closure applicable to different kind of doors, a perfect combination of esthetics and functionality.

Motion-V is an innovative and versatile rototranslating mechanism that can be used in every room.

A l'occasion du 40me anniversaire du brevet Servetto, la société présente un nouveau système d'ouverture et de fermeture breveté qui peut s'appliquer à des portes en tous genres; une parfaite synthèse entre esthétique et fonctionnalité.

Motion-V est un mécanisme pivotant/coulissant innovateur et multifonctionnel, à utiliser dans n'importe quelle ambiance.













Motion-V può essere installato all'anta dell'armadio o di altri contenitori con facilità e rapidità di installazione e non necessita di particolari regolazioni durante l'utilizzo. Può essere applicato indifferentemente al fianco destro o sinistro consentendo di scegliere la direzione di apertura dell'anta, in base alle proprie necessità. Permette una completa apertura del vano armadio, senza ostacoli.

Motion-V kann leicht und schnell an Schranktüren oder Wand installiert werden und braucht keine spezielle Regulierung während des Gebrauchs. Kann an der rechten oder linken Seitenwand montiert werden, ermöglicht somit die Wählbarkeit der Türöffnung nach persönlichem Bedarf. Ermöglicht die komplette Öffnung des Schrankes, ohne Behinderung.

Motion-V se instala fácilmente y rápidamente a la puerta del armario o de otros contenedores. El mecanismo no necesita de particulares ajustes durante su utilización. Se puede instalar tanto al lado derecho como al lado izquierdo del armario eligiendo la dirección de apertura de la puerta, según necesidad. Permite una apertura total del hueco sin obstáculos.

Motion-V can be easily and quickly installed to the wardrobe or to the closet doors and does not require particular adjustments in time. It can be applied to both the right and the left wardrobe side thus choosing the opening direction of the door as needed. It allows an easy and complete opening of the wardrobe without any obstacles.

Motion-V peut être fixé à la porte de l'armoire ou à d'autres supports d'une façon facile et rapide et ne demande pas de réglages particuliers pendant son usage. Il peut être fixé soit sur le côté droit et gauche en permettant de choisir la direction de l'ouverture de la porte, d'après ses propres exigences. Il permet une ouverture complète dans l'embrasure de l'armoire.



MOTION-V V1,V2,V3

Motion-V V1, V2, V3 è disponibile in tre dimensioni:

V1 per vani con dimensione da mm 780 a 880. Portata min. 15 max. 50 kg

V2 per vani con dimensione da mm 880 a 980. Portata min. 15 max. 50 kg

V3 per vani con dimensione da mm 980 a 1180. Portata min. 25 max. 40 kg

L'anta può essere di qualsiasi dimensione, evitando di superare la portata massima sopra indicata.

È realizzato in alluminio pressofuso nella finitura grigio (verniciato con polvere epossidica) oppure nella finitura cromo lucido.

Motion-V V1, V2, V3 ist verfügbar in drei Abmessungen:

V1 für Innenräume mit Abmessung von mm 780 bis 880. Tragkraft min. 15 max. 50 kg

V2 für Innenräume mit Abmessung von mm 880 bis 980. Tragkraft min. 15 max. 50 kg

V3 für Innenräume mit Abmessung von mm 980 bis 1180. Tragkraft min. 25 max. 40 kg

Die Tür kann jede Größe haben, darf aber die oben erwähnte Tragkraft nicht überschreiten.

Hergestellt aus Druckgussaluminium in der Ausführung grau (lackiert mit Epoxidharzpulver) oder in der Ausführung Chrom blank.

Motion-V V1, V2, V3 es disponible en tres medidas:

V1 para huecos con medidas de mm 780 a 880. Carga mín. 15 máx. 50 kg.

V2 para huecos con medidas de mm 880 a 980. Carga mín 15 máx. 50 kg.

V3 para huecos con medidas de mm 980 a 1180. Carga mín. 25 máx. 40 kg.

La puerta puede ser de cualquier dimensión, respetando las indicaciones de carga mínima y máxima.

Es realizado en aluminio fundido a presión en el acabado gris (pintado en polvo epoxi) o en el acabado cromo brillo.

Motion-V V1, V2, V3 is available in three dimensions:

V1 for inside wardrobe dimension from mm 780 to 880. Load capacity min.15 max. 50 kg.

V2 for inside wardrobe dimension from mm 880 to 980. Load capacity min. 15 max. 50 kg.

V3 for inside wardrobe dimension from mm 980 to 1180. Load capacity min. 25 max. 40 kg.

The door can be of any dimension, without exceeding the maximum load capacity.

It is made of die-cast aluminium in the finish grey (painted with epoxy powder) or in the finish bright chrome.

Motion-V V1, V2, V3 est disponible en trois dimensions:

V1 pour largeur interne de dimensions de 780 à 880 mm. Charge min.15 maxi 50 Kg.

V2 pour largeur interne de dimensions de 880 à 980 mm. Charge min. 15 maxi 50 kg.

V3 pour largeur interne de dimensions de 980 à 1180 mm. Charge min. 25 maxi 40 Kg.

La porte peut être de différentes dimensions tout en ne dépassant pas la charge maxi sus-indiquée.

Motion-V est réalisé en aluminium moulé sous pression en finition grise (vernie avec poudre epoxy) ou dans la finition chromé brillant.

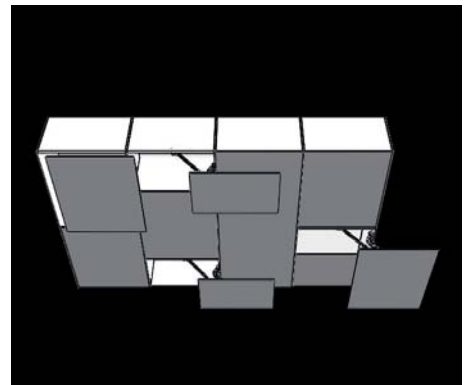
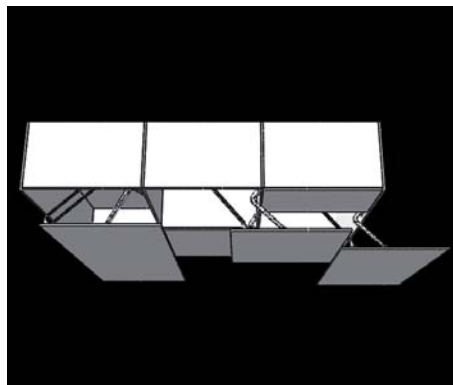
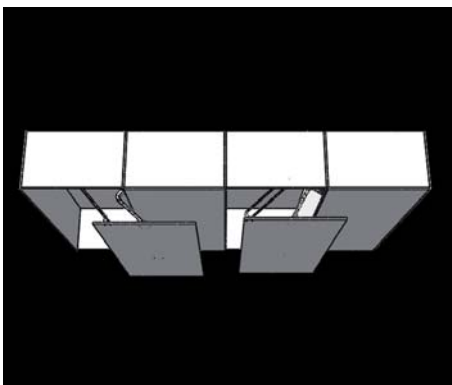
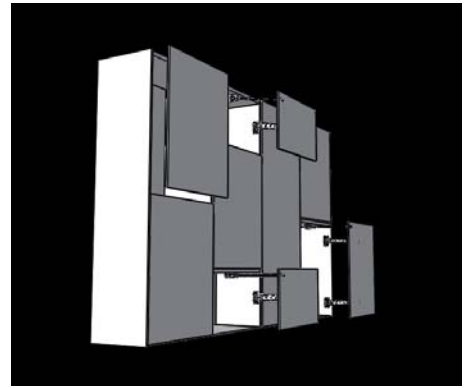
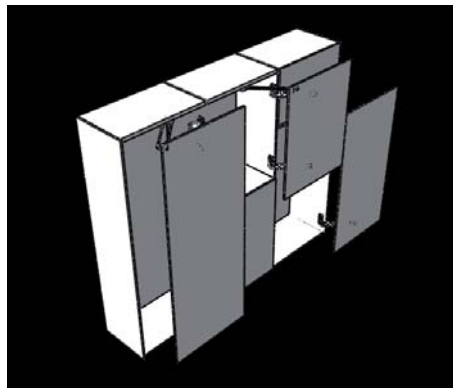
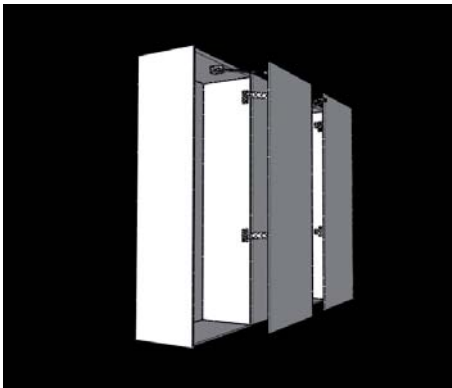
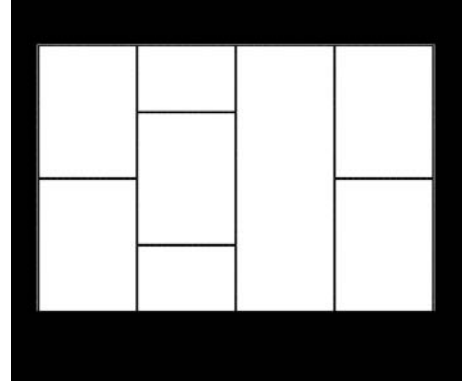
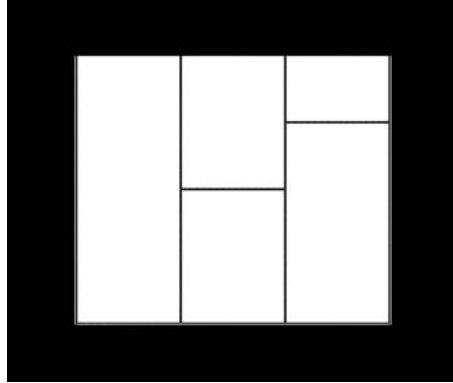
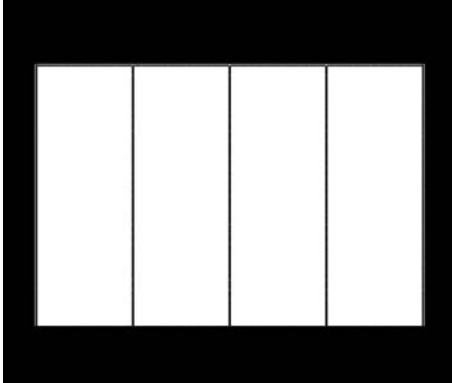

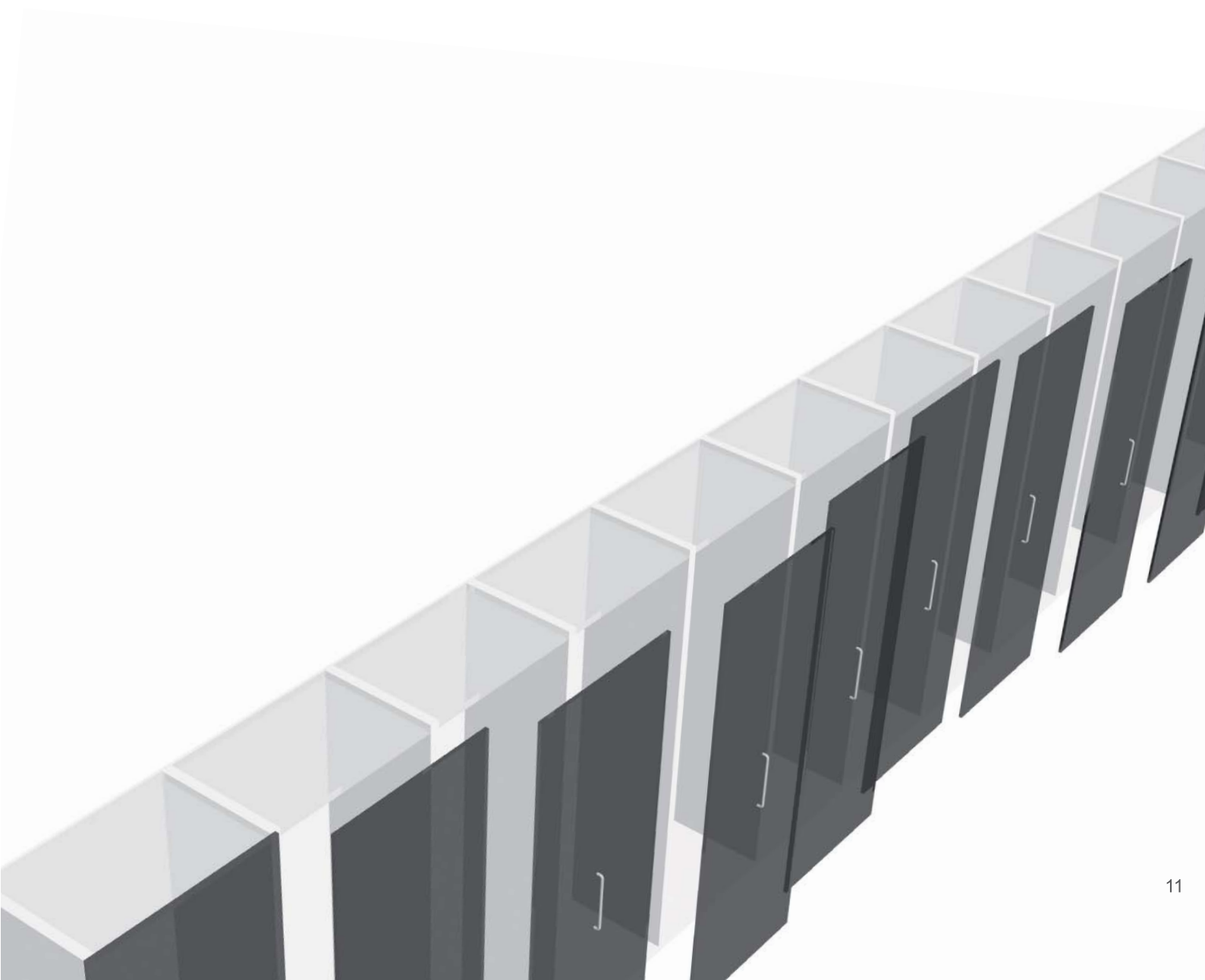

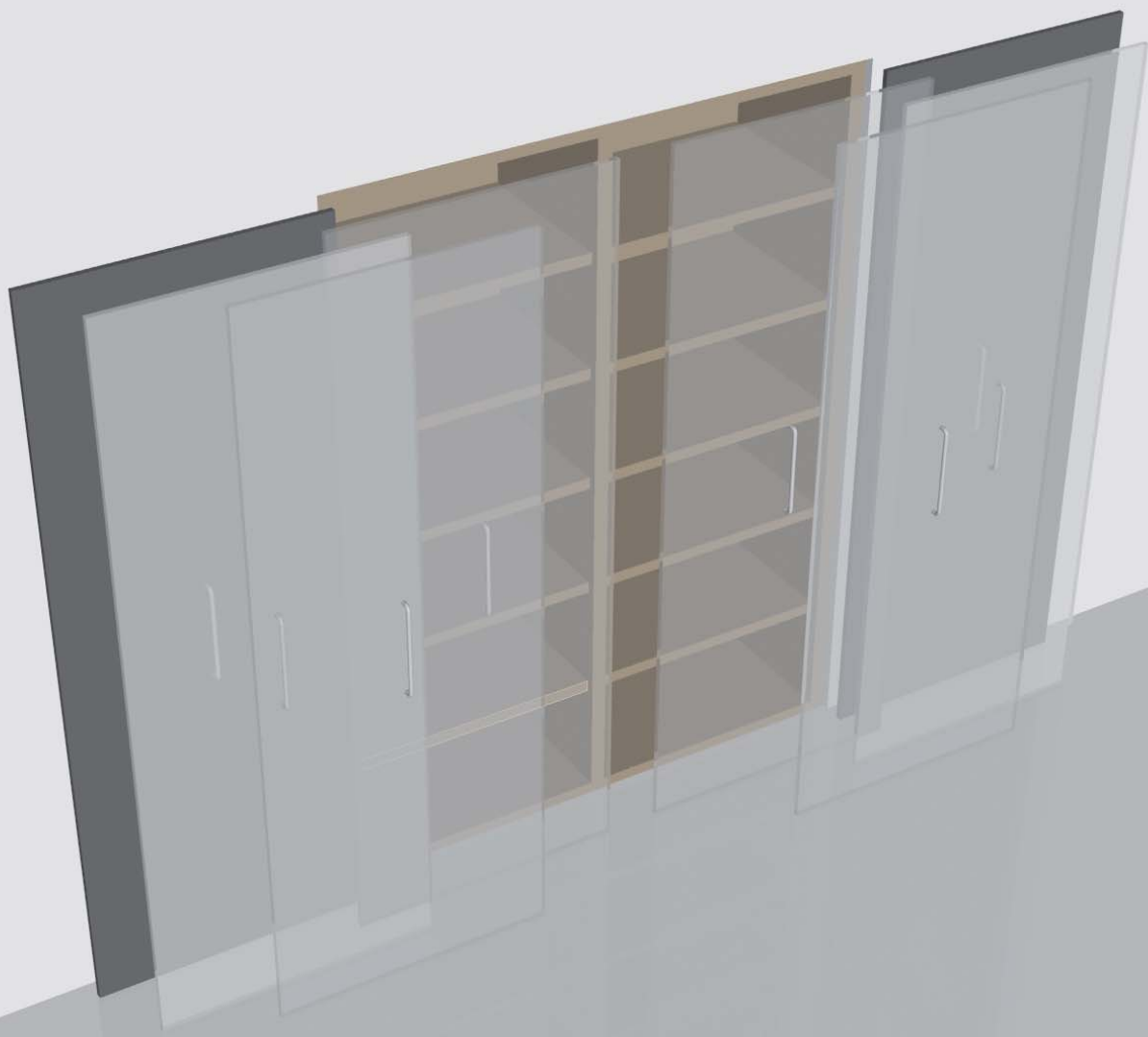

Versione MOTION-V V1 PER VANO DA MM 780 A 880
Modell MOTION-V V1 FÜR INNENRAUM VON MM 780 BIS 880
Modelo MOTION-V V1 PARA HUECOS DE MM 780 A 880
Model MOTION-V V1 FOR A WARDROBE OR A CLOSET INSIDE DIMENSION FROM MM 780 TO 880
Modèle MOTION-V V1 POUR LARGEUR INTERNE DE 780 A 880 MM

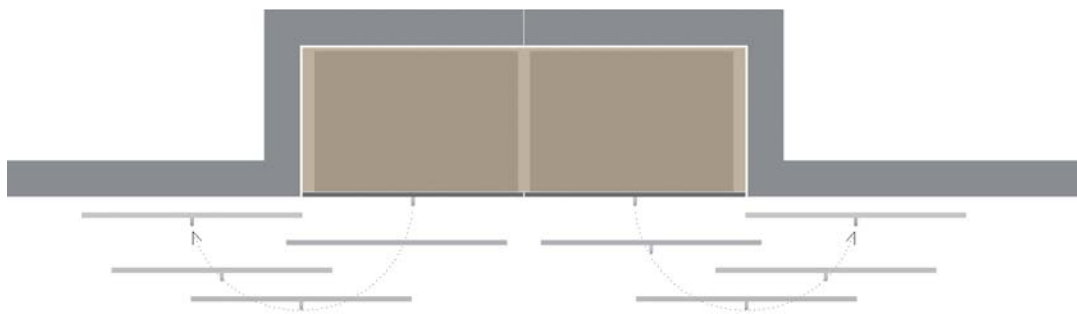

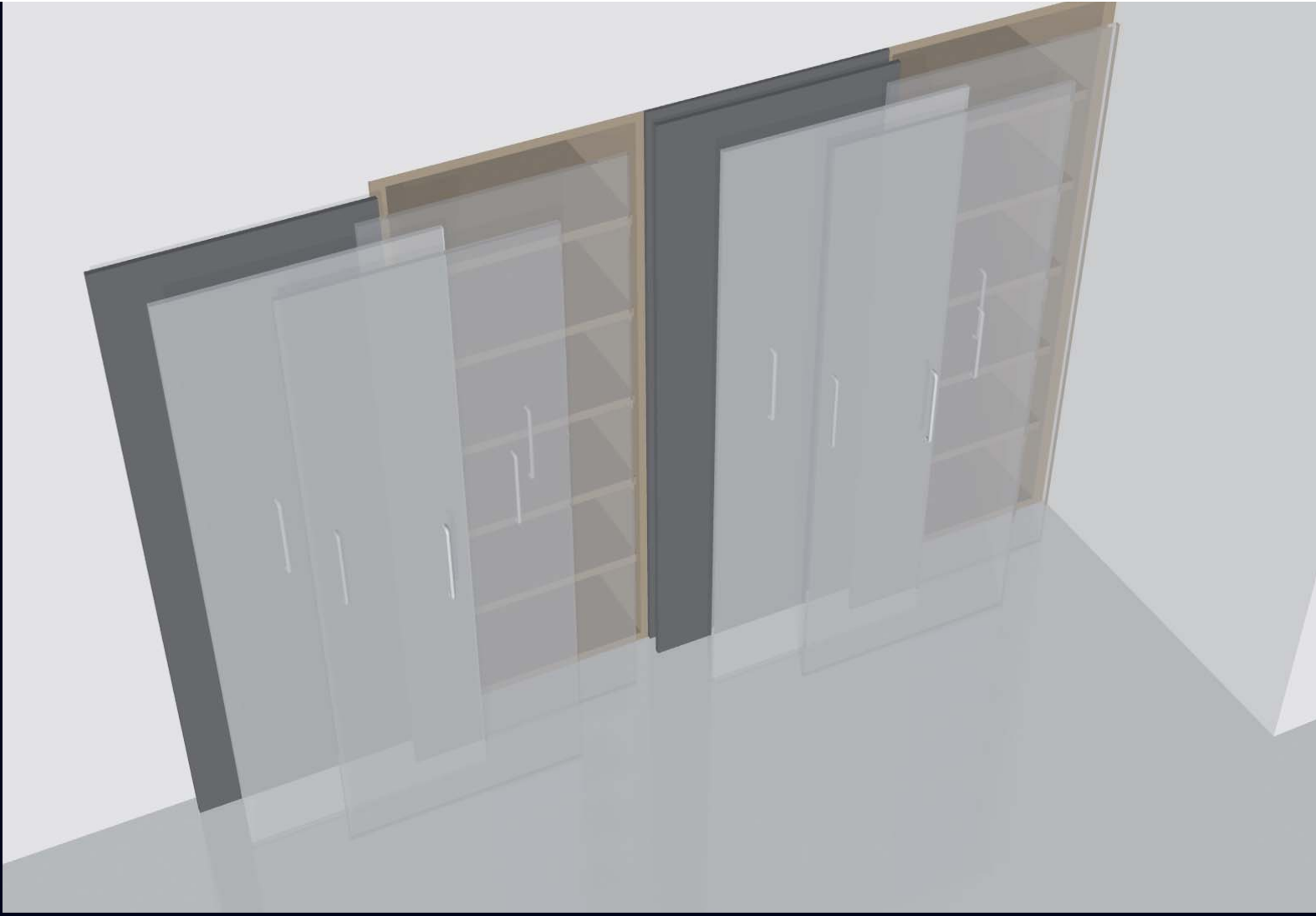

Versione MOTION-V V1 PER VANO DA MM 780 A 880
Modell MOTION-V V1 FÜR INNENRAUM VON MM 780 BIS 880
Modelo MOTION-V V1 PARA HUECOS DE MM 780 A 880
Model MOTION-V V1 FOR A WARDROBE OR A CLOSET INSIDE DIMENSION FROM MM 780 TO 880
Modèle MOTION-V V1 POUR LARGEUR INTERNE DE 780 A 880 MM

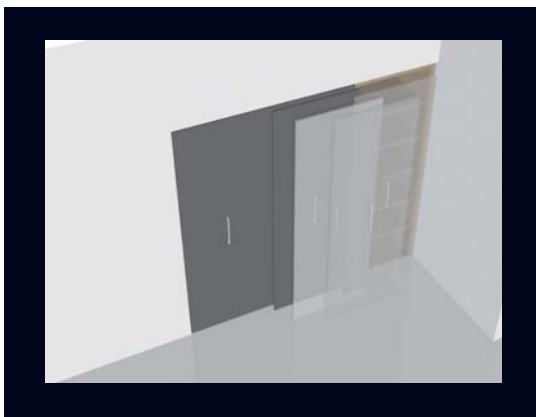
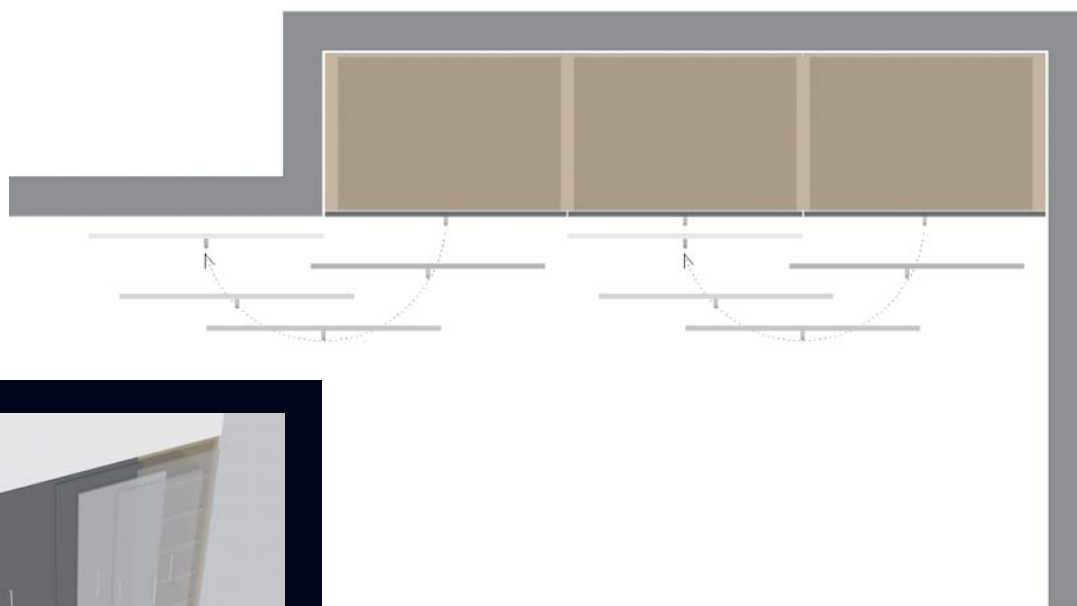

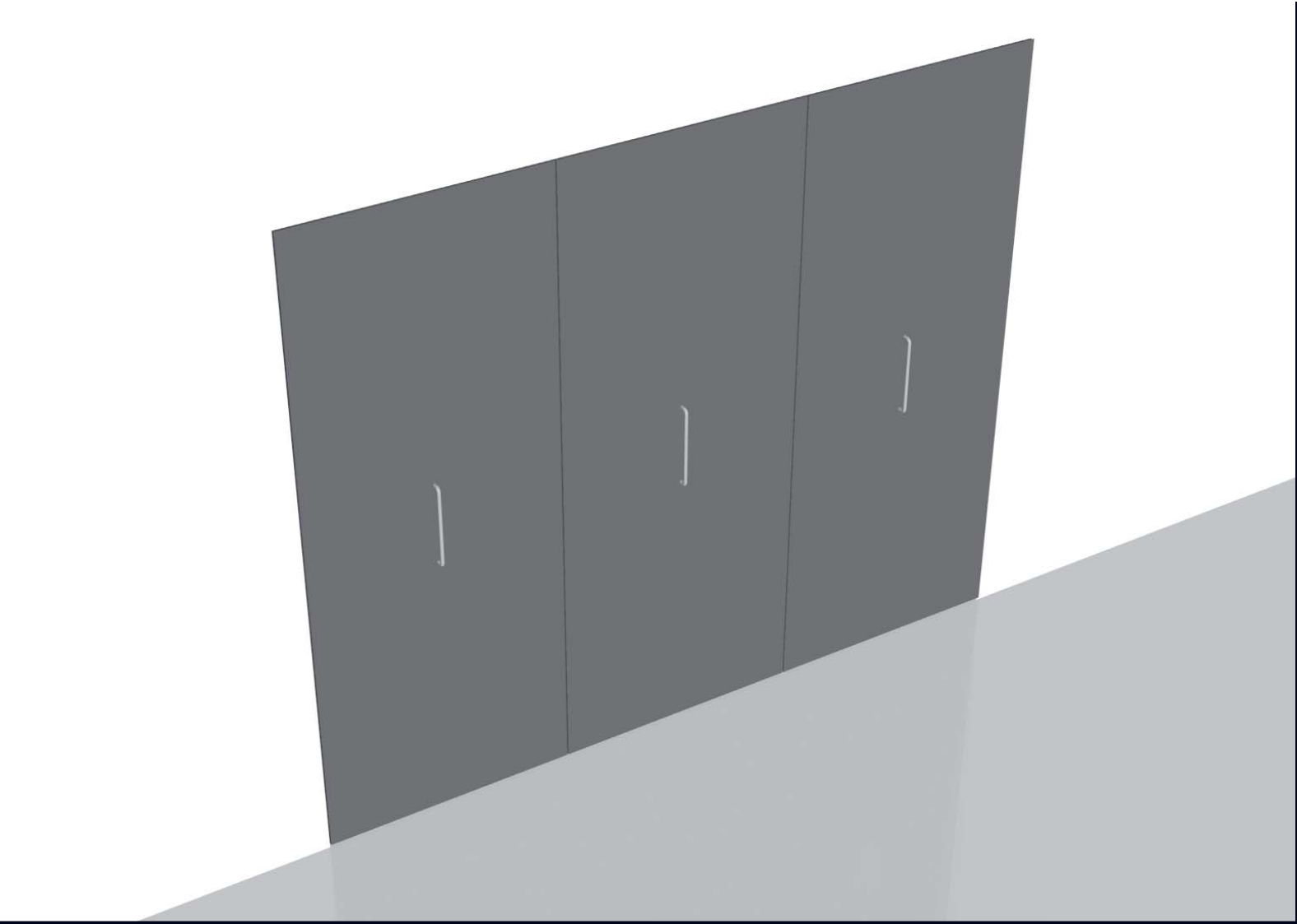

Versione MOTION-V V2 PER VANO DA MM 880 A 980
Modell MOTION-V V2 FÜR INNENRAUM VON MM 880 BIS 980
Modelo MOTION-V V2 PARA HUECOS DE MM 880 A 980
Model MOTION-V V2 FOR A WARDROBE OR A CLOSET INSIDE DIMENSION FROM MM 880 TO 980
Modèle MOTION-V V2 POUR LARGEUR INTERNE DE 880 A 980 MM



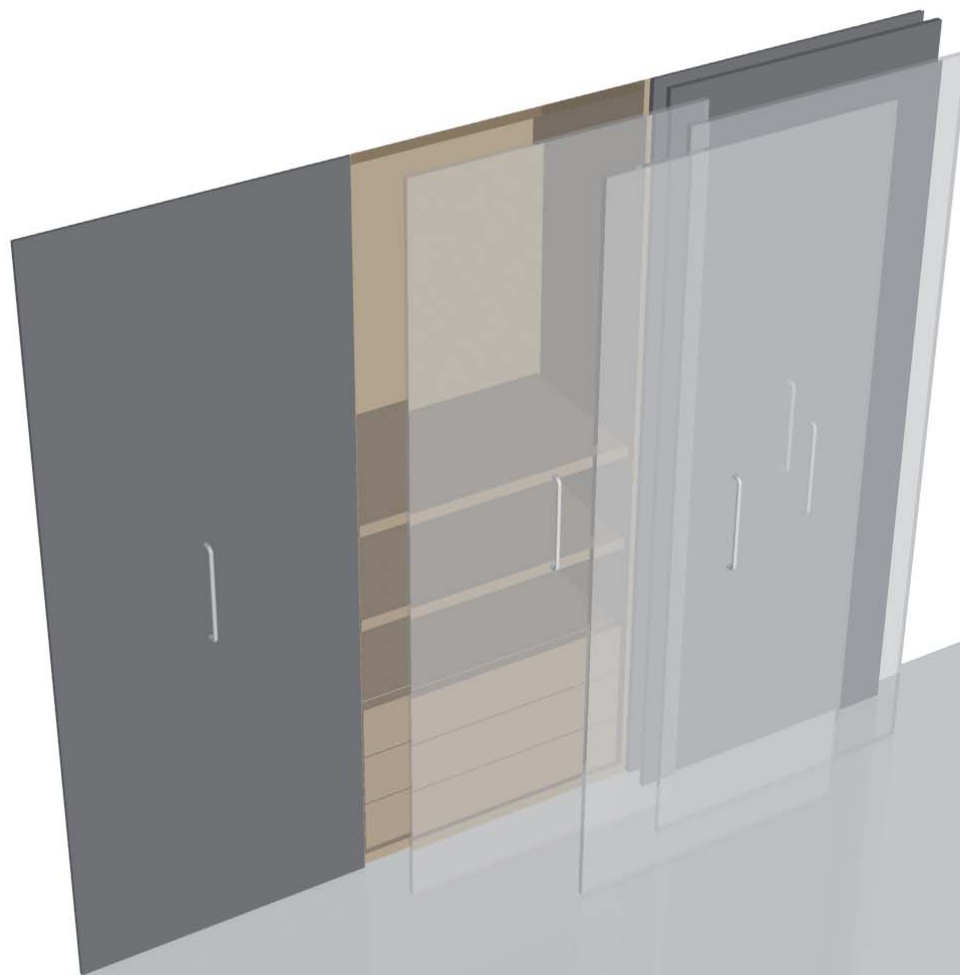

Versione MOTION-V V2 PER VANO DA MM 880 A 980
Modell MOTION-V V2 FÜR INNENRAUM VON MM 880 BIS 980
Modelo MOTION-V V2 PARA HUECOS DE MM 880 A 980
Model MOTION-V V2 FOR A WARDROBE OR A CLOSET INSIDE DIMENSION FROM MM 880 TO 980
Modèle MOTION-V V2 POUR LARGEUR INTERNE DE 880 A 980 MM

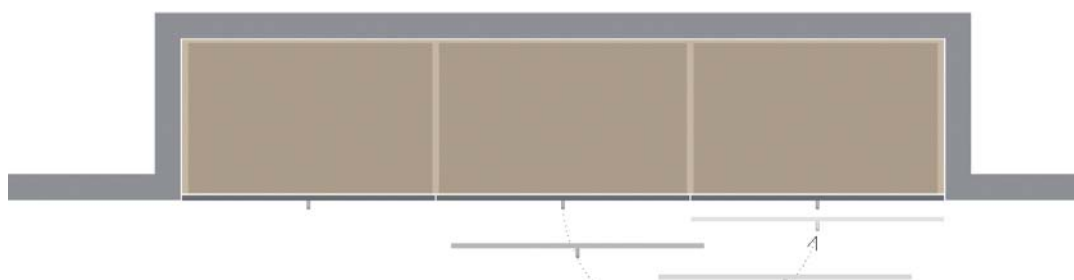

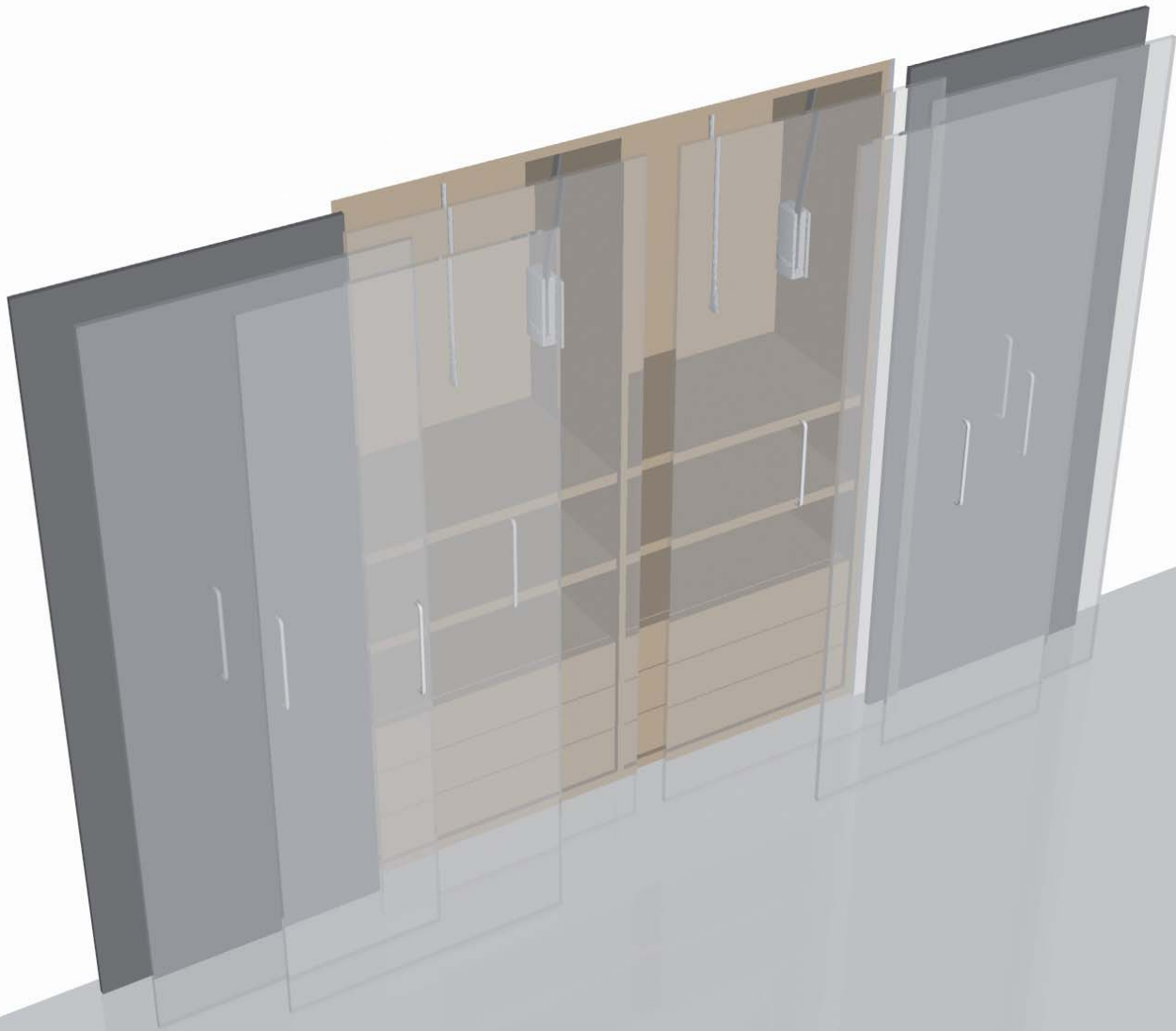

Versione MOTION-V V2 PER VANO DA MM 880 A 980
 Modell MOTION-V V2 FÜR INNENRAUM VON MM 880 BIS 980
 Modelo MOTION-V V2 PARA HUECOS DE MM 880 A 980
 Model MOTION-V V2 FOR A WARDROBE OR A CLOSET INSIDE DIMENSION FROM MM 880 TO 980
 Modèle MOTION-V V2 POUR LARGEUR INTERNE DE 880 A 980 MM

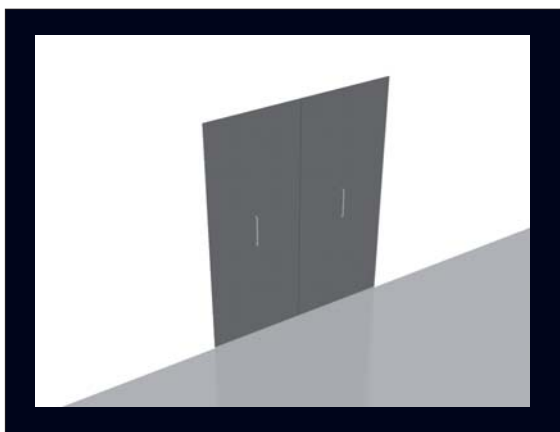
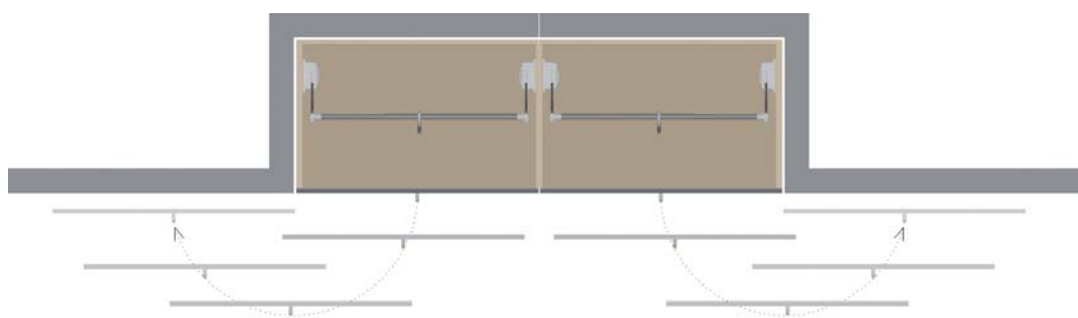

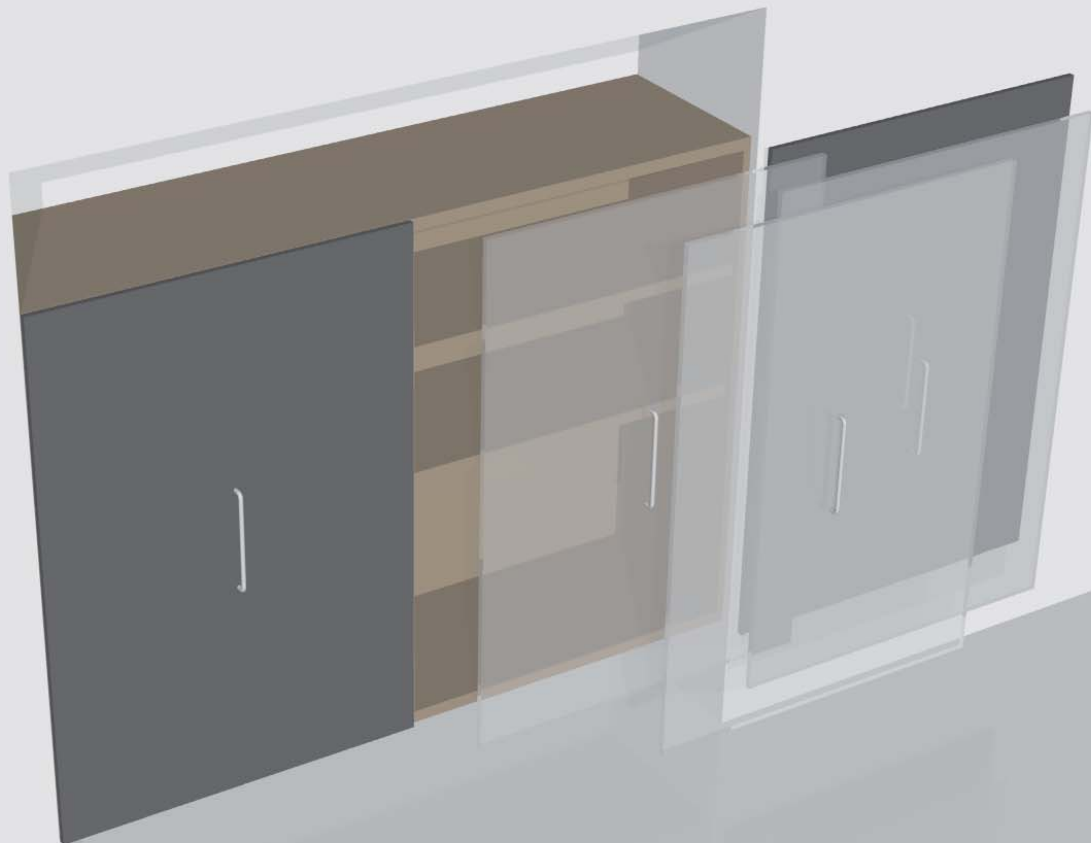

Versione MOTION-V V3 PER VANO DA MM 980 A 1180
Modell MOTION-V V3 FÜR INNENRAUM VON MM 980 BIS 1180
Modelo MOTION-V V3 PARA HUECOS DE MM 980 A 1180
Model MOTION-V V3 FOR A WARDROBE OR A CLOSET INSIDE DIMENSION FROM MM 980 TO 1180
Modèle MOTION-V V3 POUR LARGEUR INTERNE DE 980 A 1180 MM

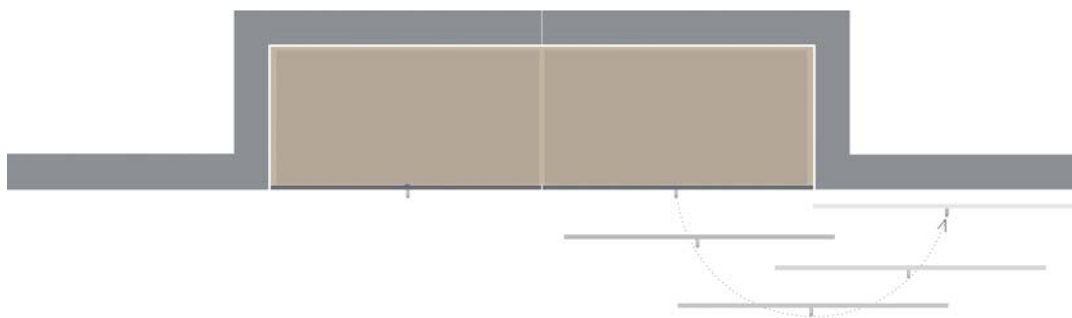

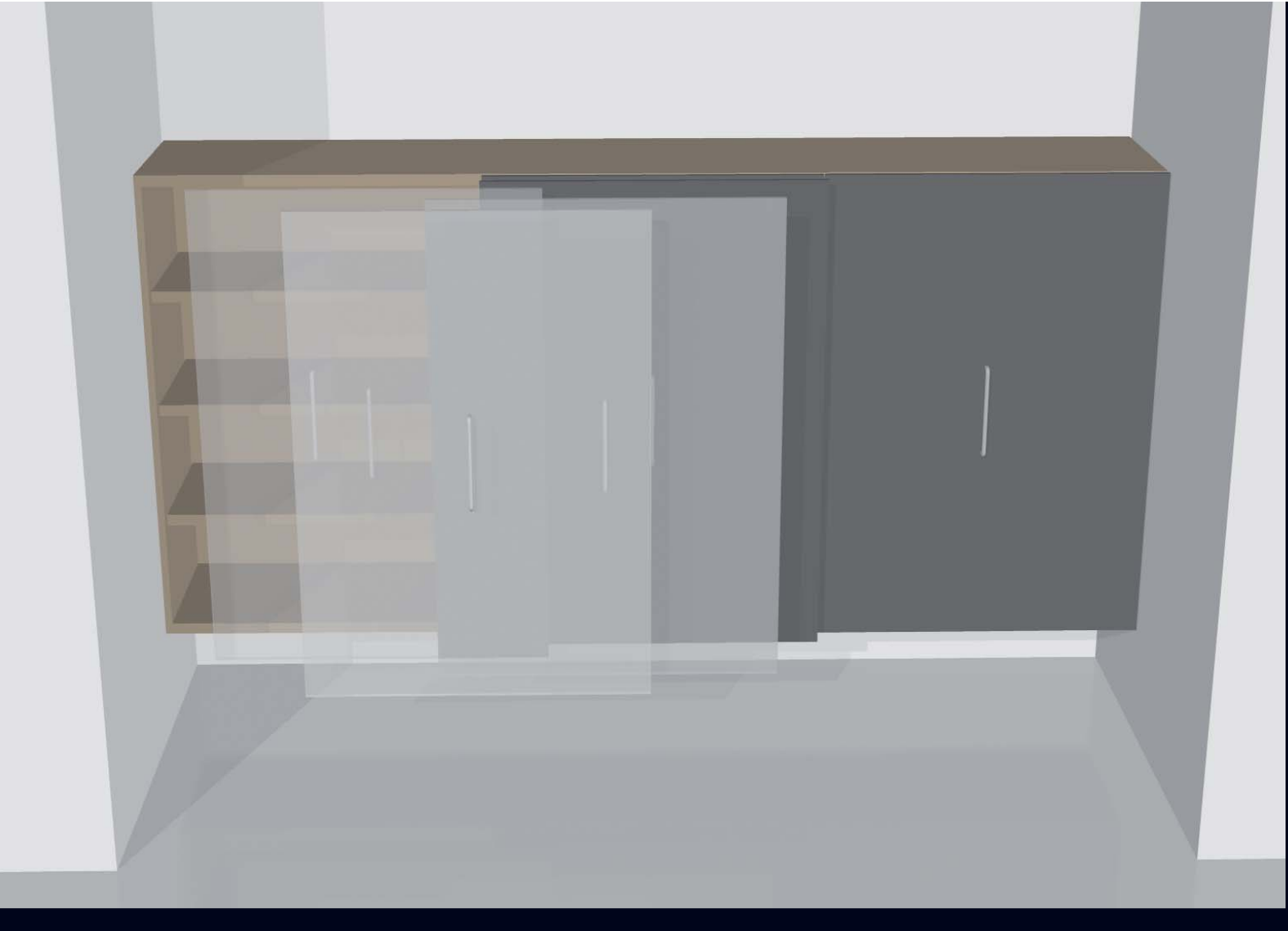

Versione MOTION-V V3 PER VANO DA MM 980 A 1180
Modell MOTION-V V3 FÜR INNENRAUM VON MM 980 BIS 1180
Modelo MOTION-V V3 PARA HUECOS DE MM 980 A 1180
Model MOTION-V V3 FOR A WARDROBE OR A CLOSET INSIDE DIMENSION FROM MM 980 TO 1180
Modèle MOTION-V V3 POUR LARGEUR INTERNE DE 980 A 1180 MM

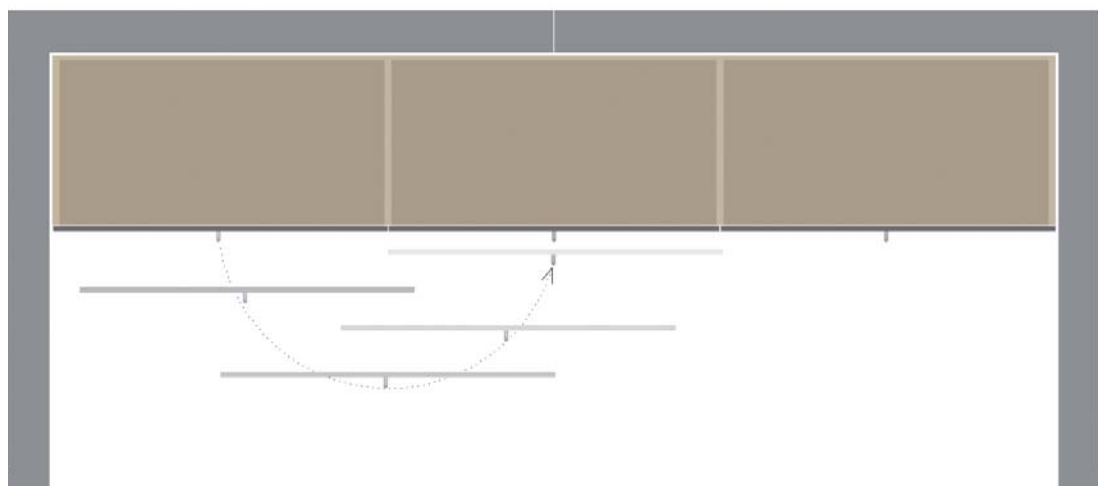









Accessori

Il meccanismo Motion-V V1, V2, V3 completa il coordinato della gamma di accessori della Servetto: appendiabiti saliscendi, doppio cassetto estraibile, portapantaloni estraibile ed estensibile, portascarpe estensibile Tac, portascarpe estraibile con 3 possibilità di posizionamento, appendiabiti Tirataka e accessori estraibili Self System (portacravatte, portacinture, portafoulard, cestello estraibile pieghevole 3 funzioni portacravatte/gonne/pantaloni).

Zubehörteile

Der Mechanismus Motion-V V1, V2, V3 vervollständigt die koordinierte Linie der Zubehörteile von Servetto: Garderobenlifte, herausziehbar doppeltes Schubladenelement, herausziehbarer und ausziehbarer Hosenhalter, ausziehbarer Schuhträger Tac, ausziehbarer Schuhträger mit 3 möglichen Positionen, Kleiderbügelhalter Tirataka und herausziehbare Zubehörteile Self System (Krawattenhalter, Gürtelhalter, Schalhalter, klappbarer 3 Funktionen Krawatten- Rock- und Hosenhalter).

Accesorios

El nuevo mecanismo Motion-V V1, V2, V3 se suma a la gama de accesorios de la Servetto: varios modelos de elevadores para armarios, doble cajon extraíble, pantalonero extraíble y extensible, zapatero extensible Tac, zapatero extraíble con tres posibles posiciones, colgador Tirataka y accesorios extraíbles Self System (corbatero, cuelga-cinturones, cuelga-pañuelos, corbatero/faldero/pantalonero extraíble y plegable).

Accessories

The mechanism Motion-V V1, V2, V3 complements the range of Servetto accessories: clothes lifts, double storage drawer, sliding and adjustable trousers-rack, adjustable shoe-rack, Tac, sliding shoe-rack with 3 possible positions, hanger Tirataka and sliding accessories Self System (tie-rack, belt-rack, scarf-rack, folding tie/trousers/skirt-rack).

Accessoires

Le mécanisme Motion-V V1, V2, V3 complète la gamme Servetto: penderies relevables, tiroir double sortie simple et extensible, porte-pantalons télescopique, porte-chaussures extensible Tac, porte-chaussures télescopique avec trois possibilités de positionnement, porte-manteau Tirataka et accessoires télescopiques Self-System (porte-cravates, porte-cintures, porte-foulards, porte-pantalons/jupes/cravates rabattables et télescopiques).

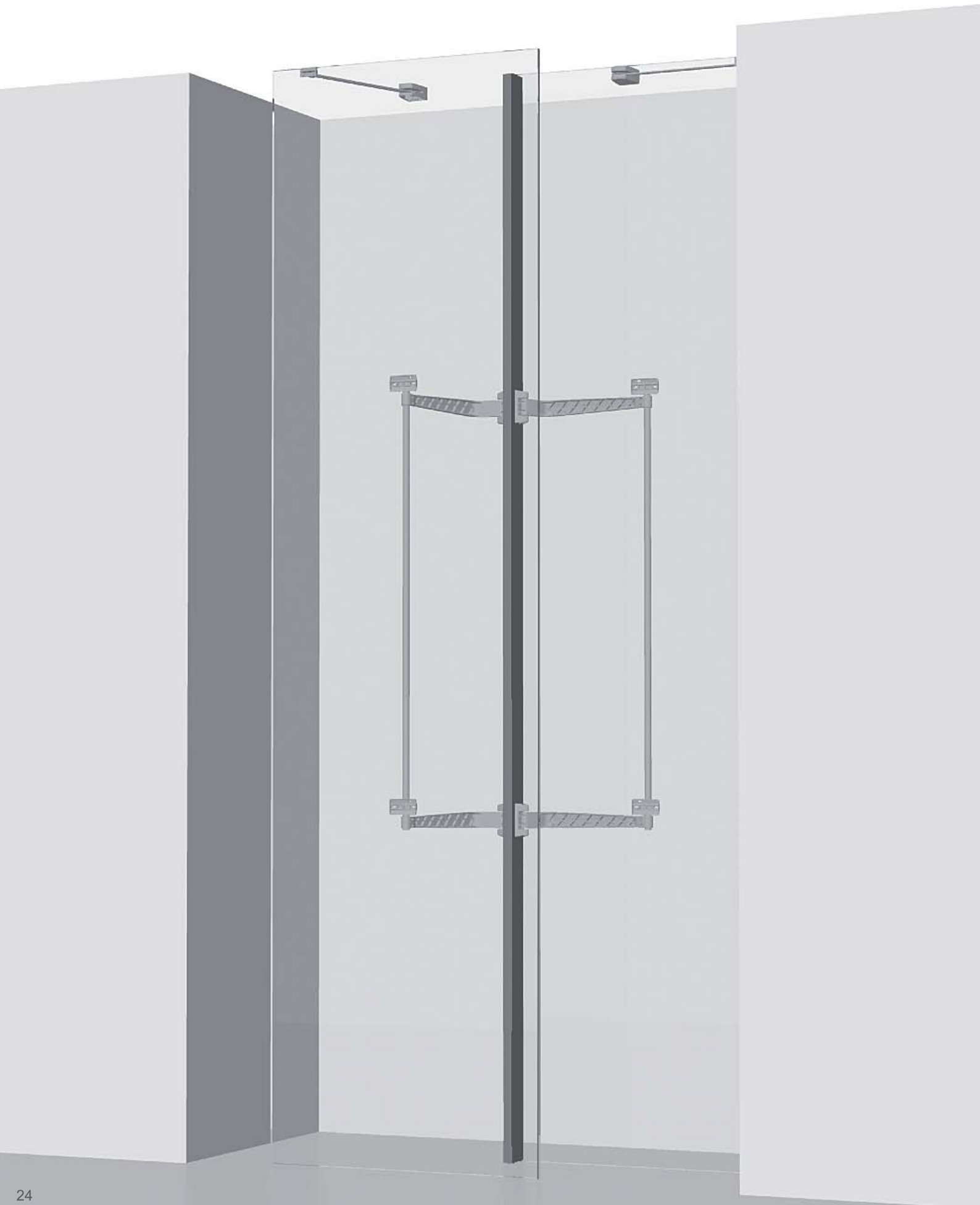

MOTION-V su cabinarmadio

Alcuni esempi di utilizzo di Motion-V V1, V2, V3 nella cabina armadio o con pareti attrezzate.

MOTION V IM BEGEBBAREM KLEIDERSCHRANK

Einige Einsetzbeispiele von Motion-V V1, V2, und V3 im begehbaren Kleiderschrank oder mit Wandausstattungen.

MOTION-V EN EL ARMARIO EMPOTRADO

Algunos ejemplos de utilización de Motion-V V1, V2, V3 en armarios empotrados y paredes equipadas.

MOTION-V IN THE CLOSET

Some examples of Motion -V V1, V2, V3 application in the closet.

MOTION-V DANS LE DRESSING

Quelques exemples d'utilisation de Motion-V V1, V2, V3 dans le dressing ou sur des murs équipés.

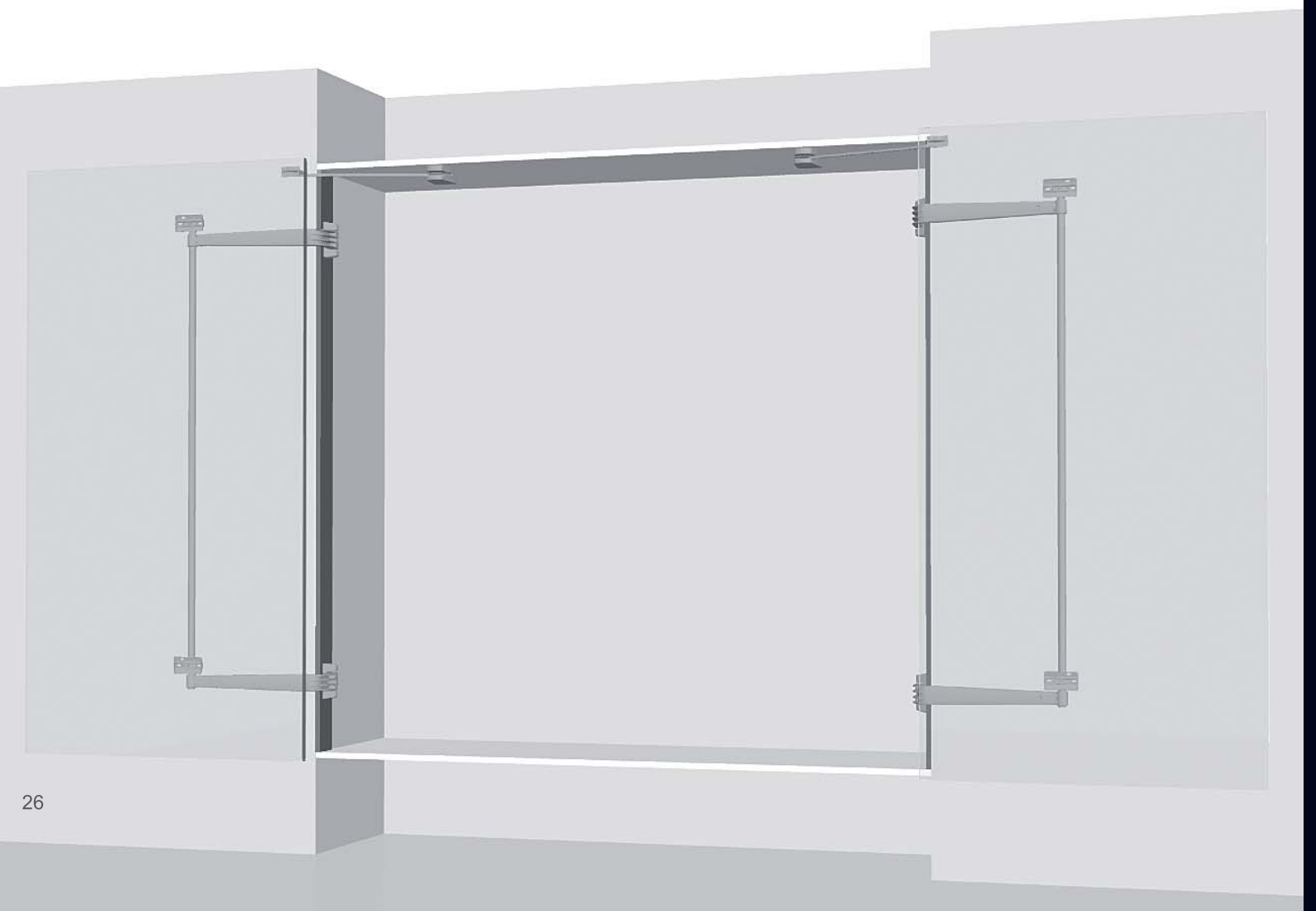
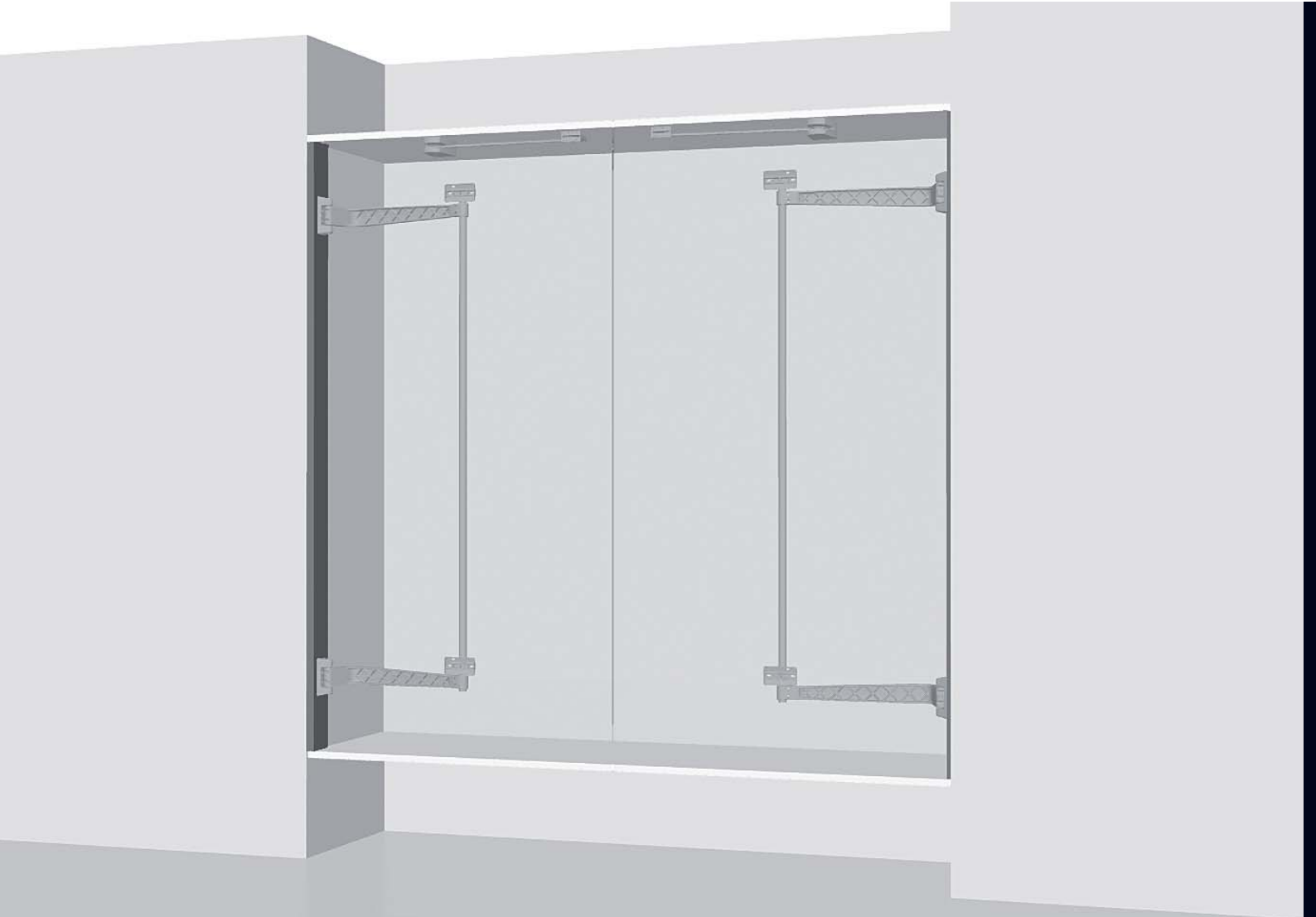

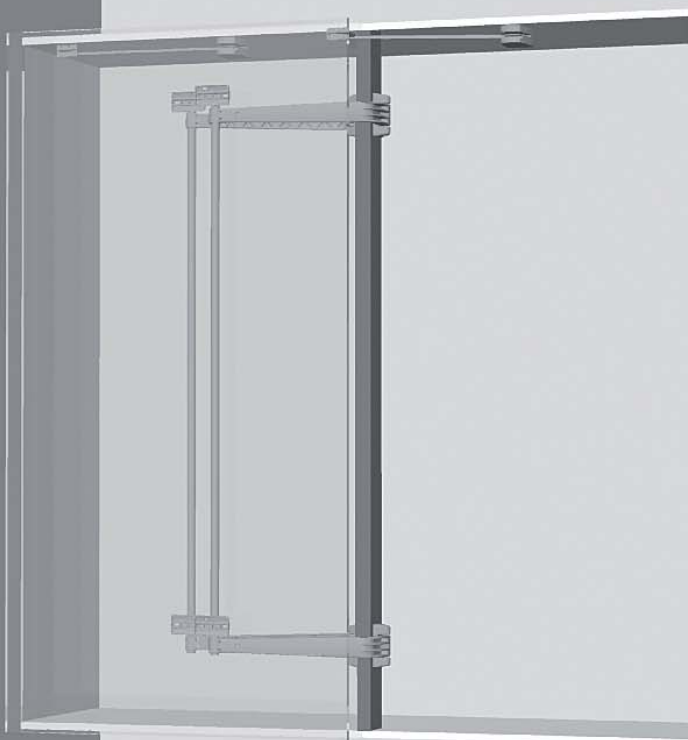
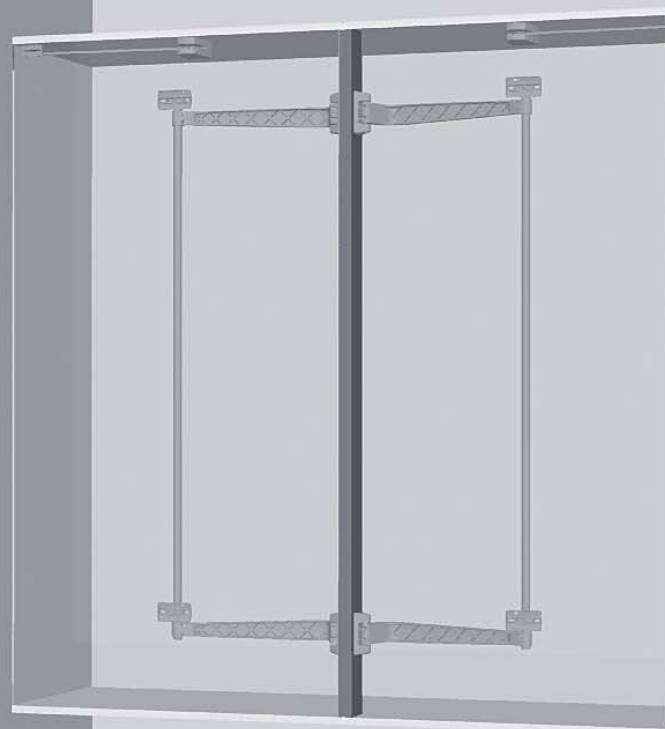





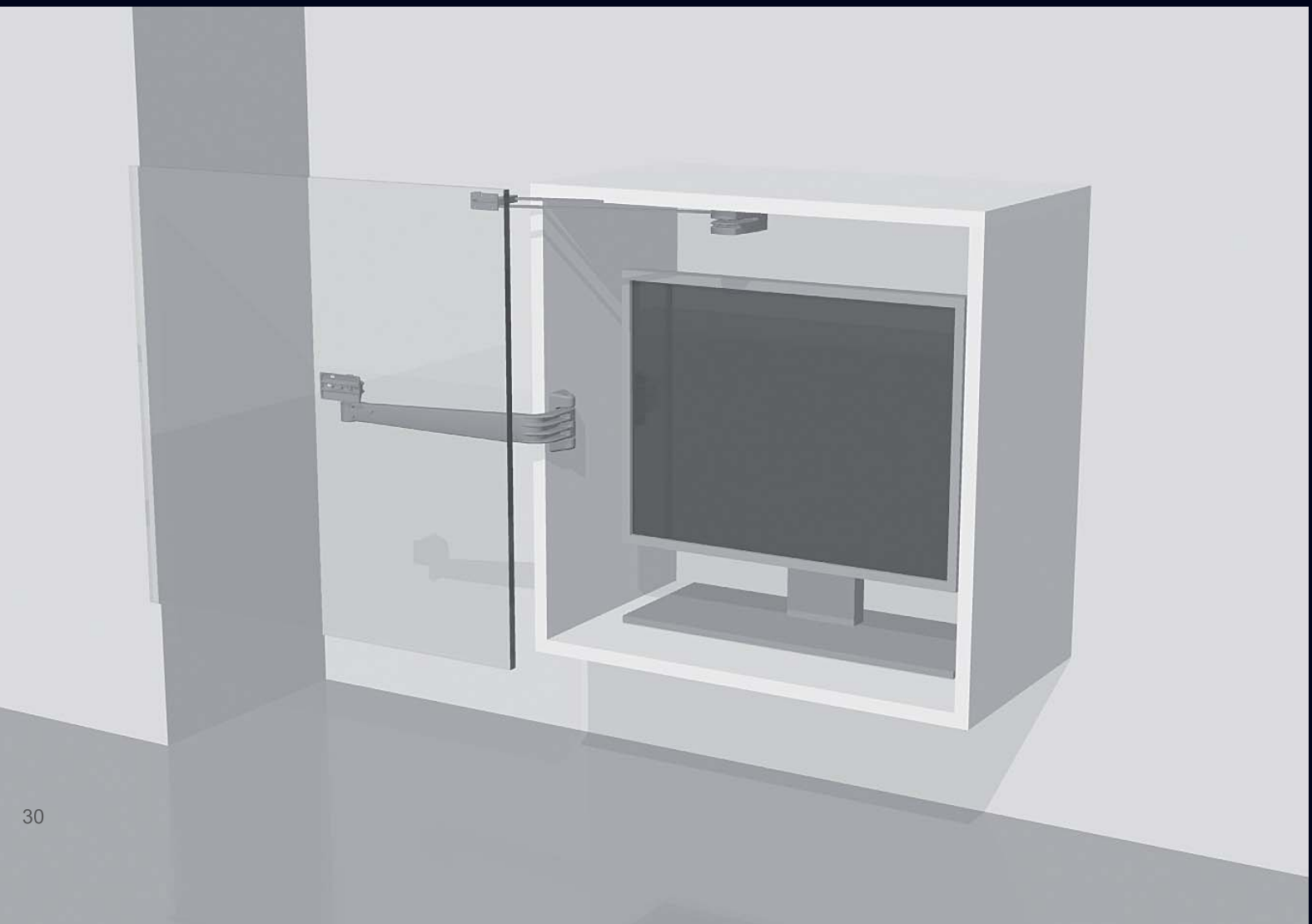
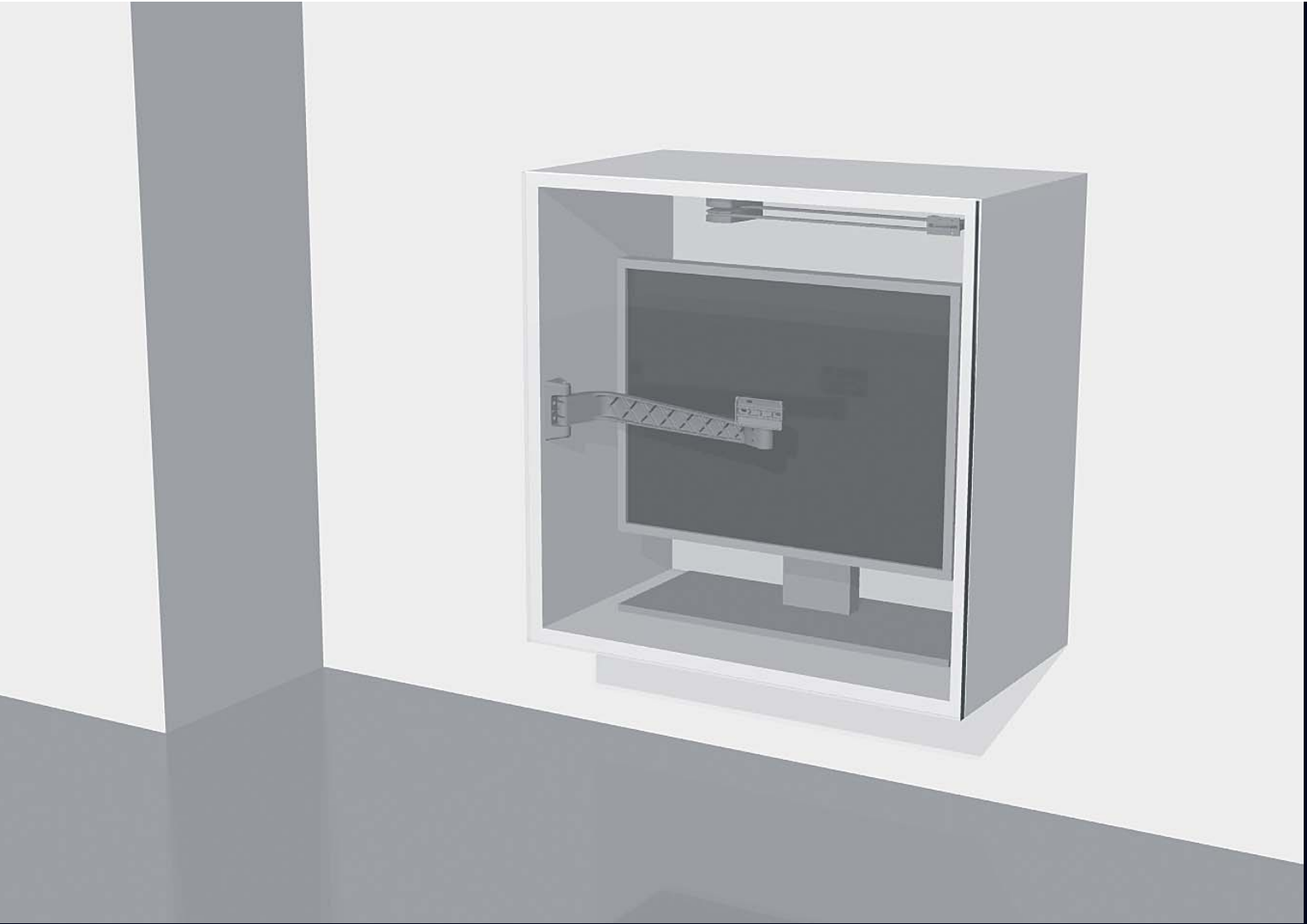







MOTION-V V1

Art. MTNV1AA00

Verniciato grigio polvere epossidica / Grau lackiert mit Epoxidharzpulver / Acabado gris pintado en polvo epoxi / Finish grey painted with epoxy powder / Finition grise vernie avec poudre epoxy

Art. MTNV1AC00

Cromo lucido / Chrom blank / Acabado cromo brillo / Finish bright chrome / Finition chromé brillant

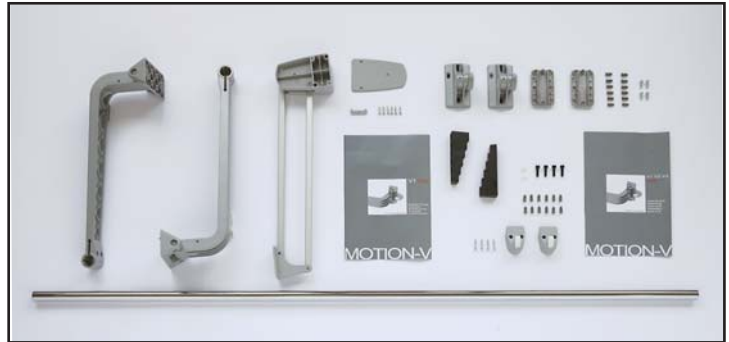
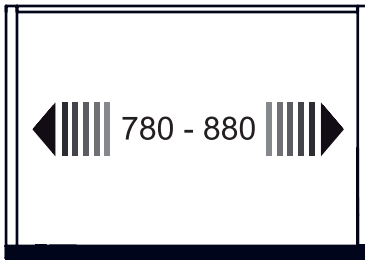

MOTION-V V2

Art. MTNV2AA00

Verniciato grigio polvere epossidica / Grau lackiert mit Epoxidharzpulver / Acabado gris pintado en polvo epoxi / Finish grey painted with epoxy powder / Finition grise vernie avec poudre epoxy

Art. MTNV2AC00

Cromo lucido / Chrom blank / Acabado cromo brillo / Finish bright chrome / Finition chromé brillant

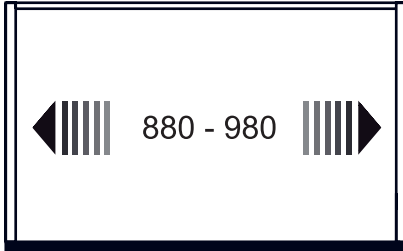

MOTION-V V3

Art. MTNV3AA00

Verniciato grigio polvere epossidica / Grau lackiert mit Epoxidharzpulver / Acabado gris pintado en polvo epoxi / Finish grey painted with epoxy powder / Finition grise vernie avec poudre epoxy

Art. MTNV3AC00

Cromo lucido / Chrom blank / Acabado cromo brillo / Finish bright chrome / Finition chromé brillant

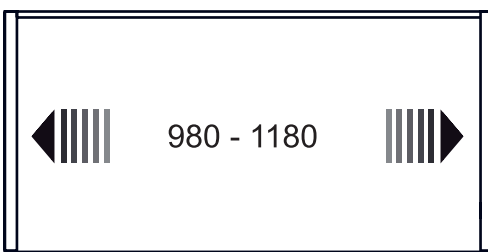

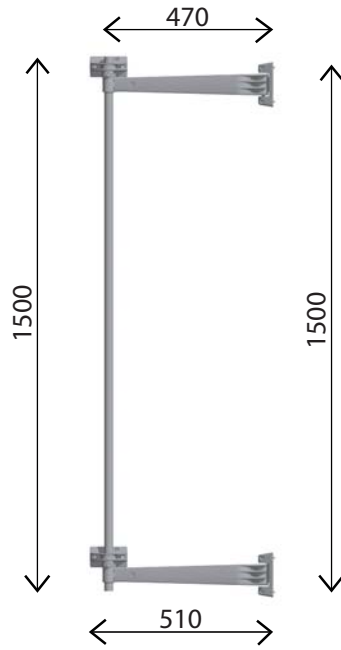

MOTION-V V1



MIN 15
MAX 50

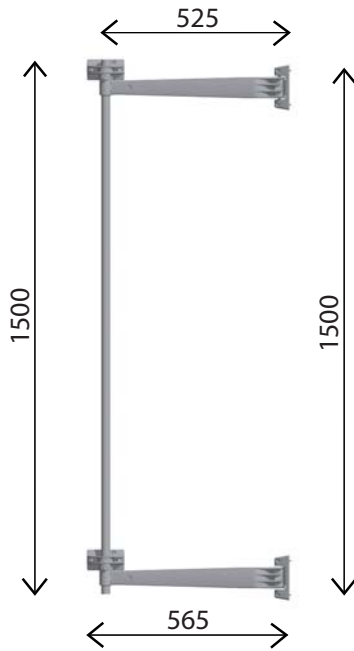

MOTION-V V2



MIN 15
MAX 50

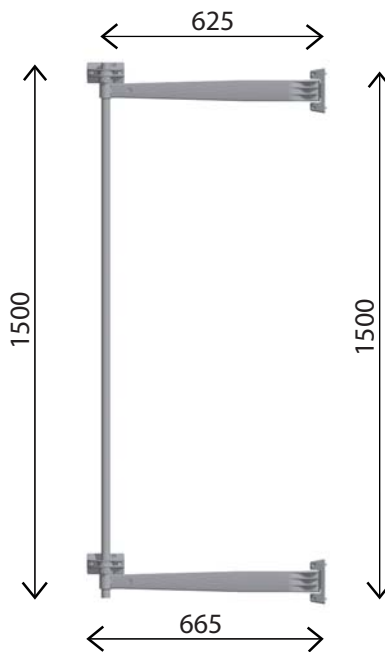

MOTION-V V3



MIN 25
MAX 40

