

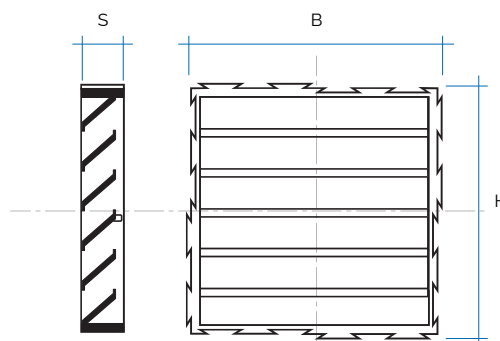



MODGB



	Codice	Colore	Rete anti insetti	BxH mm	S	Pass Air cm <sup>2</sup>		Blister p. 277
G	MODGB	bianco	<input type="checkbox"/>	100x100	18	55	120	
	MODGM	marrone						
	MODGN	nero						
G	MODGRB	bianco	<input checked="" type="checkbox"/>	100x100	18	50	120	●
	MODGRM	marrone						
	MODGRN	nero						
G	MODG20B	bianco	<input type="checkbox"/>	200x200	18	220	30	
	MODG20M	marrone						
	MODG20N	nero						
G	MODG20RB	bianco	<input checked="" type="checkbox"/>	200x200	18	200	30	●
	MODG20RM	marrone						
	MODG20RN	nero						
H	MODHB	bianco	<input type="checkbox"/>	100x100	18	70	1	
	MODHM	marrone						
	MODHN	nero						
H	MODHRB	bianco	<input checked="" type="checkbox"/>	100x100	18	60	1	●
	MODHRM	marrone						
	MODHRN	nero						

	Codice	Colore	Rete anti insetti	BxH mm	S	Pass Air cm <sup>2</sup>		Blister p. 277
L	MODLB	bianco	<input type="checkbox"/>	100x100	18	24	1	<input type="checkbox"/>
	MODLM	marrone	<input type="checkbox"/>					
	MODLN	nero	<input type="checkbox"/>					
L	MODLRB	bianco	<input checked="" type="checkbox"/>	100x100	18	20	1	<input checked="" type="checkbox"/>
	MODLRM	marrone	<input checked="" type="checkbox"/>					
	MODLRN	nero	<input checked="" type="checkbox"/>					
Z	MODZB	bianco	<input type="checkbox"/>	100x100	18	77	1	<input type="checkbox"/>
	MODZM	marrone	<input type="checkbox"/>					
	MODZN	nero	<input type="checkbox"/>					
X	MODXB	bianco	<input type="checkbox"/>	100x100	18	67	1	<input type="checkbox"/>

Da incasso

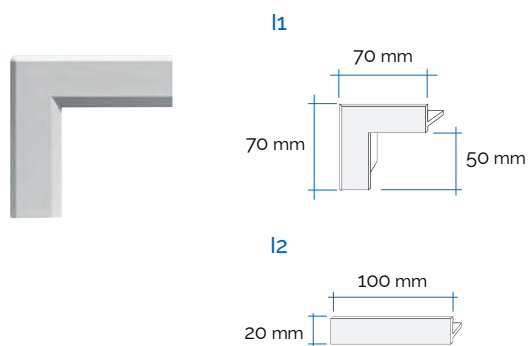

Da sovrapporre

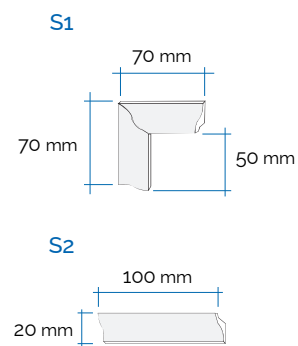

	Codice	Colore	BxH mm	P		Blister p. 277
l1	BAIB	bianco	70x70	18	100	<input checked="" type="checkbox"/>
	BAIM	marrone				
	BAIN	nero				
l2	BLIB	bianco	100x20	18	100	<input checked="" type="checkbox"/>
	BLIM	marrone				
	BLIN	nero				
S1	BASB	bianco	70x70	18	100	<input checked="" type="checkbox"/>
	BASM	marrone				
	BASN	nero				
S2	BLSB	bianco	100x20	18	100	<input checked="" type="checkbox"/>
	BLSM	marrone				
	BLSN	nero				

# Bordi e modulo 15x15 per composizioni tipo "G" **ABS**



MODG15B

Da incasso

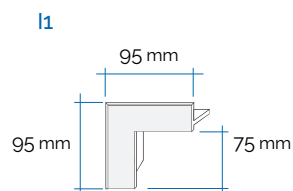

l2

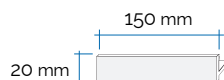



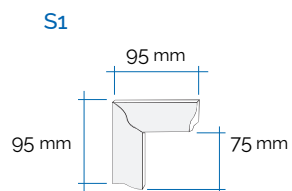





Da sovrapporre



S2



	Codice	Colore	Rete anti insetti	BxH mm	S	Pass Air cm <sup>2</sup>	
	MODG15B	bianco	<input type="checkbox"/>	150x150	18	100	1
	MODG15RB	bianco	<input checked="" type="checkbox"/>	150x150	18	90	1

	Codice	Colore	BxH mm	P	
	BAIB15	bianco	95x95	18	100
	BAIM15	marrone			
	BAIN15	nero			
	BLIB15	bianco	150x20	18	100
	BLIM15	marrone			
	BLIN15	nero			
	BASB15	bianco	95x95	18	100
	BASM15	marrone			
	BASN15	nero			
	BLSB15	bianco	150x20	18	100
	BLSM15	marrone			
	BLSN15	nero			