

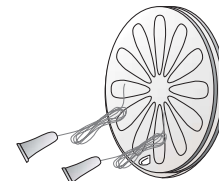









Dosatore - sistema di regolazione del flusso d'aria



Funicelle - applicate al dosatore, consentono la regolazione a distanza del flusso d'aria

Codice	Colore	Rete anti insetti	Øe mm	S	Foro Øf mm	Pass Air cm <sup>2</sup>		Blister p. 275
T63B	bianco	<input type="checkbox"/>	80	15	60	20	60	
T63M	marrone	<input type="checkbox"/>						
T63N	nero	<input type="checkbox"/>						
T63RB	bianco	<input type="checkbox"/>	80	15	60	20	60	●
T63RM	marrone	<input checked="" type="checkbox"/>						
T63RN	nero	<input checked="" type="checkbox"/>						
T8B	bianco	<input type="checkbox"/>	96	16	77	50	30	
T8M	marrone	<input type="checkbox"/>						
T8N	nero	<input type="checkbox"/>						
T8RB	bianco	<input type="checkbox"/>	96	16	77	50	30	●
T8RM	marrone	<input checked="" type="checkbox"/>						
T8RN	nero	<input checked="" type="checkbox"/>						
T8RRAN	ramato	<input type="checkbox"/>						
T8DB	bianco	<input type="checkbox"/>	96	16	77	25	30	
T8DM	marrone	con dosatore						
T8DRB	bianco	<input checked="" type="checkbox"/>	96	16	77	25	30	●
T8DRM	marrone	con dosatore						
T8DSB	bianco	<input type="checkbox"/>	96	16	77	25	30	
T8DSM	marrone	con dosatore e funicelle						
T8DSRB	bianco	<input checked="" type="checkbox"/>	96	16	77	25	30	
T8DSRM	marrone	con dosatore e funicelle						

Codice	Colore	Rete anti insetti	Øe mm	S	Foro Øf mm	Pass Air cm <sup>2</sup>		Blister  p. 275
T10B	bianco	<input type="checkbox"/>	120	16	97	70	20	
T10M	marrone	<input type="checkbox"/>						
T10N	nero	<input type="checkbox"/>						
T10RB	bianco	<input checked="" type="checkbox"/>	120	16	97	70	20	
T10RM	marrone							
T10RN	nero							
T10RRAN	ramato							
T10RS	sabbia							
T10DB	bianco	<input type="checkbox"/>	120	16	97	35	20	
T10DM	marrone	con dosatore						
T10DRB	bianco	<input checked="" type="checkbox"/>	120	16	97	35	20	
T10DRM	marrone							
T10DSB	bianco	<input type="checkbox"/>	120	16	97	35	20	
T10DSM	marrone	con dosatore e funicelle						
T10DSRB	bianco	<input checked="" type="checkbox"/>	120	16	97	35	20	
T10DSRM	marrone							
T11B	bianco	<input type="checkbox"/>	130	17	103	80	20	
T11M	marrone							
T11N	nero							
T11RB	bianco	<input checked="" type="checkbox"/>	130	17	103	80	20	
T11RM	marrone							
T11RN	nero							
T12B	bianco	<input type="checkbox"/>	150	17	121	100	20	
T12M	marrone							
T12N	nero							
T12RB	bianco	<input checked="" type="checkbox"/>	150	17	121	100	20	
T12RM	marrone							
T12RN	nero							
T12RRAN	ramato							
T12RS	sabbia							
T12DB	bianco	<input type="checkbox"/>	150	17	121	50	20	
T12DM	marrone	con dosatore						
T12DRB	bianco	<input checked="" type="checkbox"/>	150	17	121	50	20	
T12DRM	marrone							
T12DSB	bianco	<input type="checkbox"/>	150	17	121	50	20	
T12DSM	marrone	con dosatore e funicelle						
T12DSRB	bianco	<input checked="" type="checkbox"/>	150	17	121	50	20	
T12DSRM	marrone							

Codice	Colore	Rete anti insetti	Øe mm	S	Foro Øf mm	Pass Air cm²		Blister  p. 275
T16B T16M	bianco marrone	<input type="checkbox"/>	190	18	157	135	40	
T16RB T16RM T16RRAN	bianco marrone ramato	<input checked="" type="checkbox"/>	190	18	157	135	40	●
T16DB T16DM	bianco marrone	<input type="checkbox"/> con dosatore	190	18	157	70	40	
T16DRB T16DRM	bianco marrone	<input checked="" type="checkbox"/> con dosatore	190	18	157	70	40	●
T16DSB T16DSM	bianco marrone	<input type="checkbox"/> con dosatore e funicelle	190	18	157	70	40	
T16DSRB T16DSRM	bianco marrone	<input checked="" type="checkbox"/> con dosatore e funicelle	190	18	157	70	40	
T20B T20M	bianco marrone	<input type="checkbox"/>	238	22	193	240	20	
T20RB T20RM	bianco marrone	<input checked="" type="checkbox"/>	238	22	193	220	24	●
T20DB T20DM	bianco marrone	<input type="checkbox"/> con dosatore	238	22	193	120	24	
T20DRB T20DRM	bianco marrone	<input checked="" type="checkbox"/> con dosatore	238	22	193	120	24	●
T20DSB T20DSM	bianco marrone	<input type="checkbox"/> con dosatore e funicelle	238	22	193	110	24	
T20DSRB T20DSRM	bianco marrone	<input checked="" type="checkbox"/> con dosatore e funicelle	238	22	193	110	24	
T25B T25M	bianco marrone	<input type="checkbox"/>	290	25	240	330	10	
T25RB T25RM	bianco marrone	<input checked="" type="checkbox"/>	290	25	240	260	10	



KT16B  
T16B + T16RB

Codice	=	Griglia	+	Rete anti insetti	Colore	Øe mm	Foro Øf mm	Pass Air cm <sup>2</sup>	
KT12B KT12M	=	 T12	+	 T12R	<input type="checkbox"/> bianco <input type="checkbox"/> marrone	150	120	100	12
KT16B KT16M	=	T16	+	T16R	<input type="checkbox"/> bianco <input type="checkbox"/> marrone	190	160	135	12
KT20B KT20M	=	T20	+	T20R	<input type="checkbox"/> bianco <input type="checkbox"/> marrone	238	200	220	12
KT25B KT25M	=	T25	+	T25R	<input type="checkbox"/> bianco <input type="checkbox"/> marrone	290	250	260	15

# Griglie tonde da incasso alette dritte

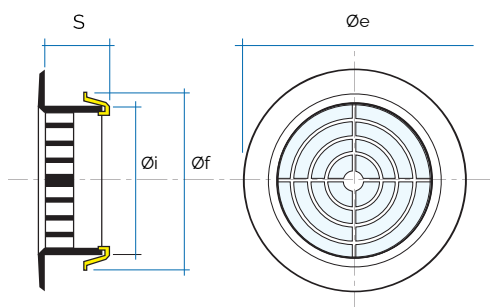

Codice	Colore	Pass Air cm <sup>2</sup>	Rete anti insetti	Øe mm	Øi mm	S	Foro Øf mm	
TF8B	<input type="checkbox"/> bianco	30	<input type="checkbox"/>	105	71	28	80	30
TF8RB	<input type="checkbox"/> bianco	15	<input type="checkbox"/>					
TF10B	<input type="checkbox"/> bianco	50	<input type="checkbox"/>	128	91	28	100	30
TF10RB	<input type="checkbox"/> bianco	25	<input checked="" type="checkbox"/>					
con dosatore								
TF10DB	<input type="checkbox"/> bianco	-	<input type="checkbox"/>	128	91	28	100	30
TF10DRB	<input type="checkbox"/> bianco	-	<input checked="" type="checkbox"/>					
TF12B	<input type="checkbox"/> bianco	65	<input type="checkbox"/>	147	110	37	125	30
TF12RB	<input type="checkbox"/> bianco	30	<input checked="" type="checkbox"/>					
con dosatore								
TF12DB	<input type="checkbox"/> bianco	-	<input type="checkbox"/>	147	110	37	125	30
TF12DRB	<input type="checkbox"/> bianco	-	<input checked="" type="checkbox"/>					
TF16B	<input type="checkbox"/> bianco	115	<input type="checkbox"/>	178	146	37	160	30
TF16RB	<input type="checkbox"/> bianco	50	<input checked="" type="checkbox"/>					