

Viti a clip per serramenti in PVC

SPK





Informazioni tecniche

SPK-BS

Forma della testa: adatta ai diversi
profili PVC
Impronta: Cruciforme H

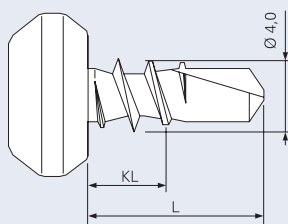

SPK-GS

Forma della testa: adatta ai diversi
profili PVC
Impronta: Cruciforme H

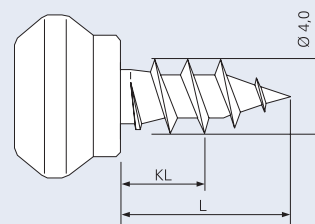

Ulteriori informazioni

Materiale:

SPK-BS: Acciaio al carbonio
SPK-GS: Acciaio carboniturato.

Trattamento di superficie:

GS bianco color argento senza cromo VI,
resistenza alla corrosione oltre 400 ore.

Posa:



Avvitatore manuale
o automatico.
La versione immagazzinata
con macchina di posa CF35.
(vedi pag. 98).

Esecuzioni speciali:

Su richiesta si possono sviluppare dei
fissaggi speciali adatti ai diversi profili.

Forma della testa adattata al profilo

Per ogni tipo di profilo

Punta filettata

La vite penetra facilmente
nel PVC grazie alla filettatura
progressiva
(filetto fino in punta)

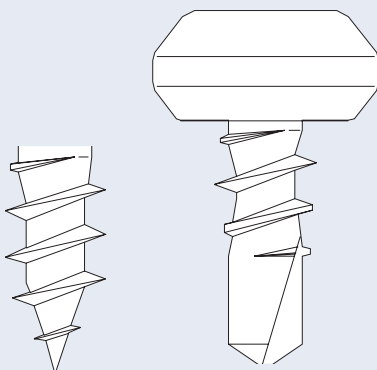

Scanalatore



Garantisce un appoggio perfetto

Punta autoforante

Permette il fissaggio
nel rinforzo fino a 3mm

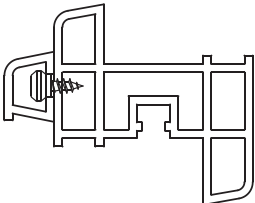
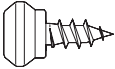
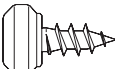
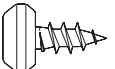

SPK autofilettante

Applicazione	Codice ordinazione	Lunghezza utile KL (mm)	Codice articolo Scatola da 1.000
	Tipo	ØxL	
Fissaggio nel profilo in PVC 	 Veka + gocciolatoio Alphacan SPK/ 5-68/GS 4 x 10	5	946397
	 Salamander SPK/ 5-69/GS 4 x 9,8	5	1116226
	 Alphacan, Hoku SPK/ 5-70/GS 4 x 9,8	5	1116228
	 Deceuninck, KBE, Rehau, Inoutic, Roplasto Guida tapparella Alphacan SPK/ 5-74/GS 4 x 10 SPK/ 7-81/GS 4 x 12	5 7	1116241 1116243
	Menke SPK/ 5-75/GS 4 x 10	5	1116245

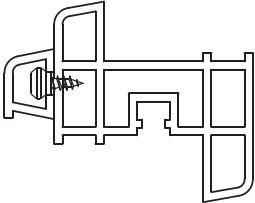
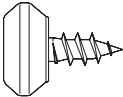
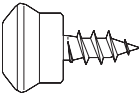
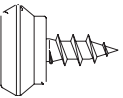
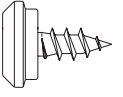

SPK autofilettante

Applicazione	Codice ordinazione		Lunghezza utile KL (mm)	Codice articolo Scatola da 1.000	
	Tipo	ØxL			
Fissaggio nel profilo in PVC 	 Alphacan, KBE, Profex, Trocal				
	SPK/ 5-84/GS	4 x 10	5	747379	
	 Kömmerling, Gealan				
	SPK/ 5-86/GS	4 x 10	5	1116247	
	 Alphacan				
	SPK/ 5-90/GS	4 x 10	5	1116260	
	 Schüco, Aluplast				
	SPK/ 5-91/GS	4 x 10	5	1116261	