

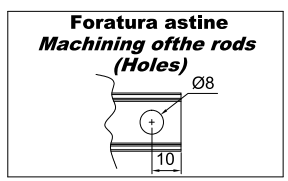

CATENACCIO A LEVA BI-HID per anta affiancata

TWO-WAY MECHANISM FOR SECONDARY SASH

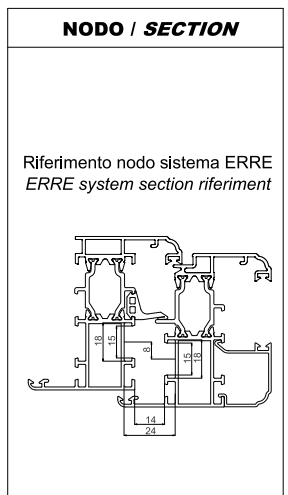
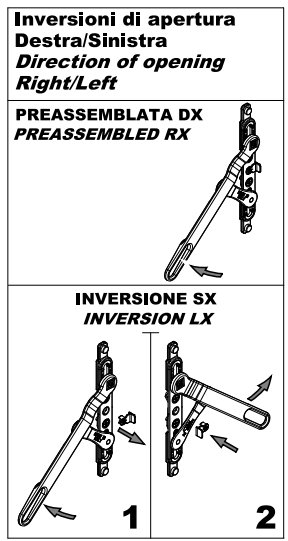
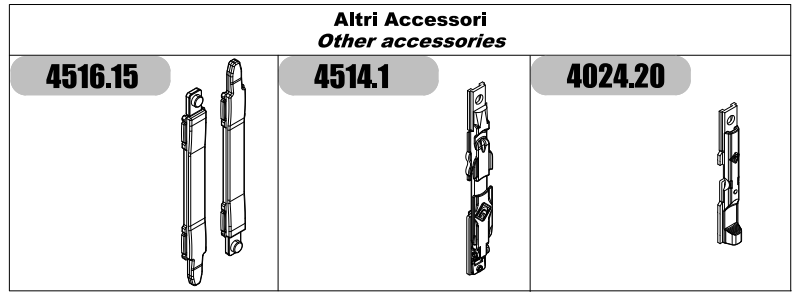
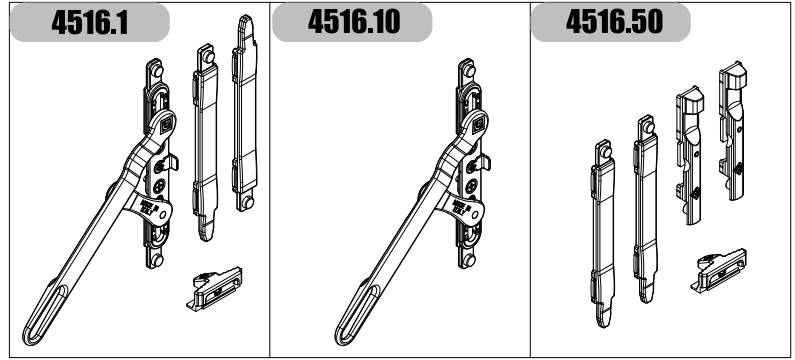
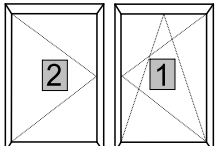
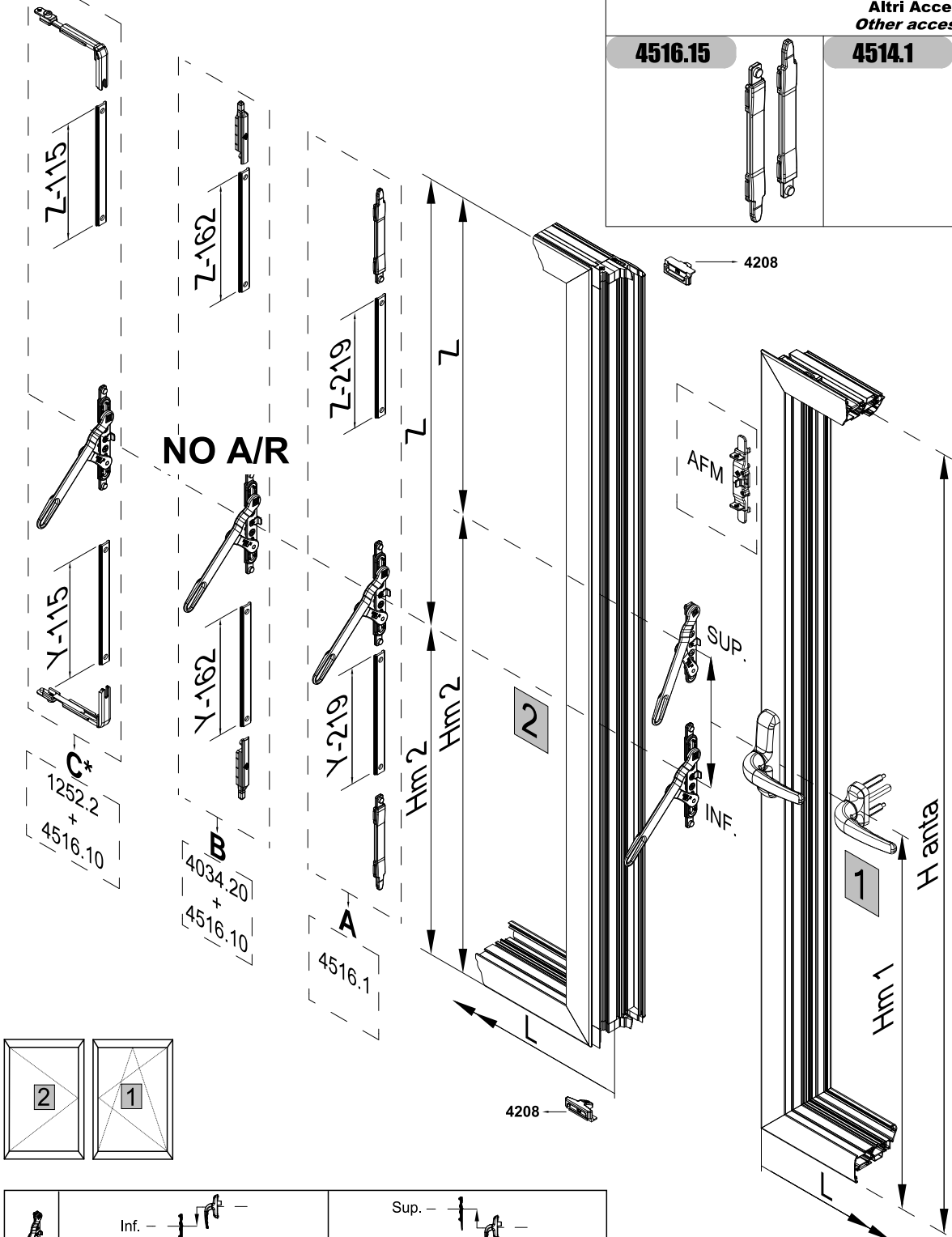

	Inf. —  —				Sup. —  —			
	H anta min.	H anta min. (AFM)	H m min.	L min.	H anta min.	H anta min. (AFM)	H m min.	L min.
1	800	900	Hm1	550	800	1100	Hm1	550
			490				300	
2	800	900	Hm2	370	800	1100	Hm2	370
			Hm1-210				Hm1+244	

4208 4208 4208 4208

A				
B				
C*				

C* = Utilizzabile solo con tappi di riporto idonei
 It can be used only with suitable facing plugs