



WEEN

BRACCIO LIMITATORE DI APERTURA CON CHIAVE DI SGANCIO



Braccio limitatore di apertura con chiave di sgancio | Limiter for opening with release key | Bras limiteur d'ouverture avec clef a declic | Compás limitador de apertura con llave de desenganche



Bracci in acciaio inox AISI 304, blocchetto limitatore di apertura in delrin, chiave di sgancio in alluminio pressofuso.



AISI 304 stainless steel arms, Delrin opening limit block, die-cast aluminum release key.



Bras en acier inox AISI 304, bloc limiteur d'ouverture en delrin, clef à dé clic en aluminium moulé sous pression.



Compases de acero inox AISI 304, bloque limitador de apertura de delrin, llave de desenganche de aluminio.

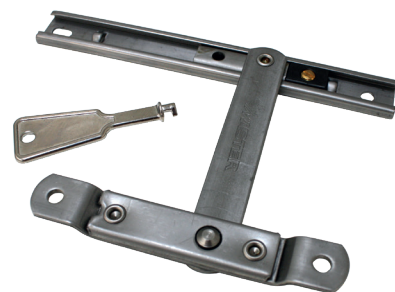

| ART. | 1203A.6 1203A.8 1203A.10 | 1203.1 | | |
|---|------------------------------|--------|---|---|
| Imballo Package Conditionnement Embalaje | 5 Cp | 10 PZ | | |
| Finiture disponibili Available finishes Finitions disponibles Acabados disponibles | 2 3 4 | 2 | 3 | 4 |

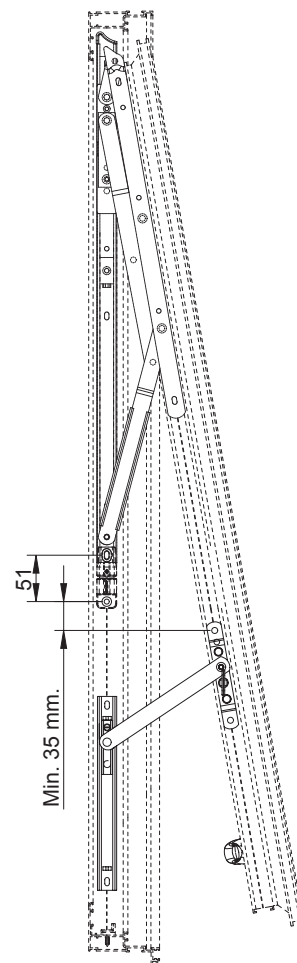
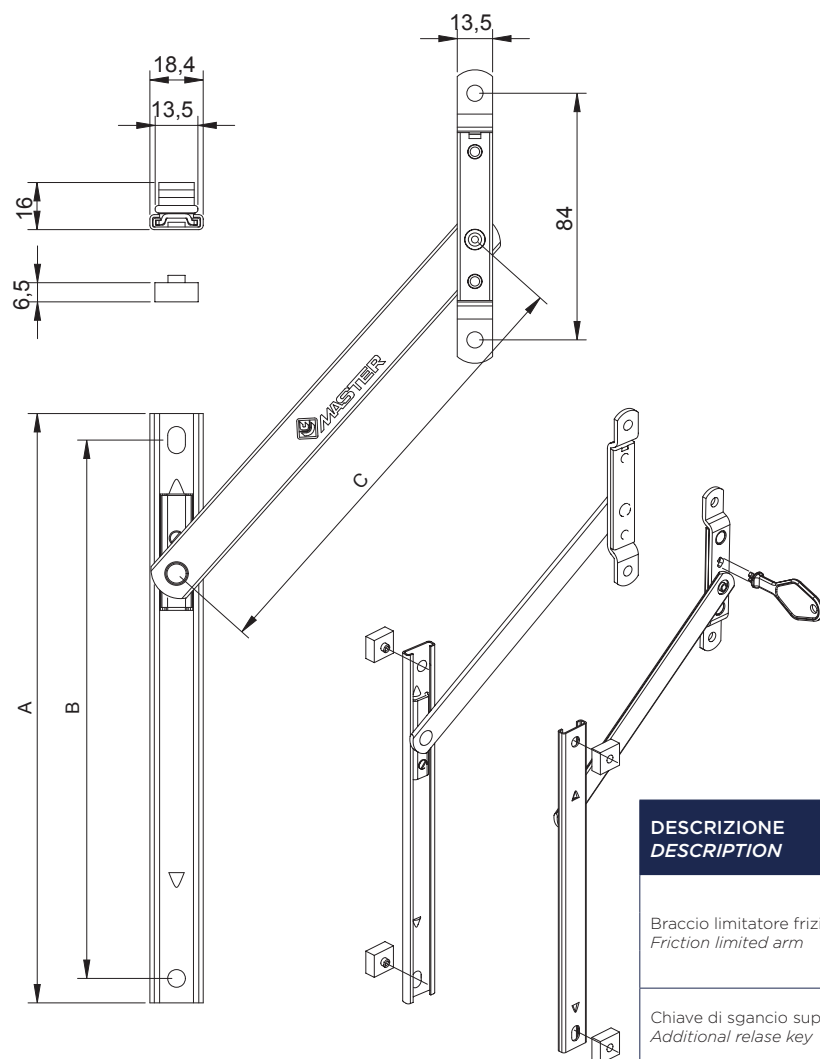

| DESCRIZIONE DESCRIPTION | ART. | (INCH) | A (MM) | B (MM) | C (MM) | NODI SECTION |
|---|----------|--------|-----------|-----------|-----------|-----------------|
| Braccio limitatore frizionato Friction limited arm | 1203A.6 | 6" | 150,5 | 131 | 85,4 | A01 - A02 |
| | 1203A.8 | 8" | 201 | 184 | 152 | A01 - A02 |
| | 1203A.10 | 10" | 254 | 236 | 180 | A01 - A02 |
| Chiave di sgancio supplementare Additional release key | 1203.1 | | | | | A01 - A02 |



WEEN

BRACCIO LIMITATORE DI APERTURA CON CHIAVE DI SGANCIO



Braccio limitatore di apertura con chiave di sgancio | Limiter with release key | Bras limiteur d'ouverture avec clef a declic | Compás limitador de apertura con llave de desenganche



Bracci in acciaio inox AISI 304, blocchetto limitatore di apertura in delrin, chiave di sgancio in alluminio pressofuso.



AISI 304 stainless steel arms, Delrin opening limit block, die-cast aluminum release key.



Bras en acier inox AISI 304, bloc limiteur d'ouverture en delrin, clef à dé clic en aluminium moulé sous pression.



Compases de acero inox AISI 304, bloque limitador de apertura de delrin, llave de desenganche de aluminio.

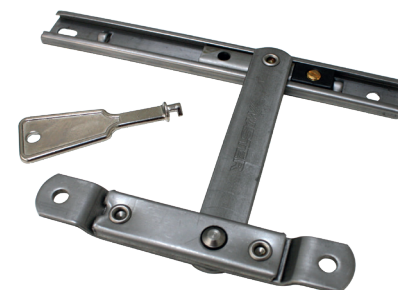

| ART. | 1203A.6 1203A.8 1203A.10 | 1203.1 |
|---|------------------------------|---------|
| Imballo Package Conditionnement Embalaje | 5 Cp | 10 PZ |
| Finiture disponibili Available finishes Finitions disponibles Acabados disponibles | 1 2 3 4 | 1 2 3 4 |

ANTA | SASH

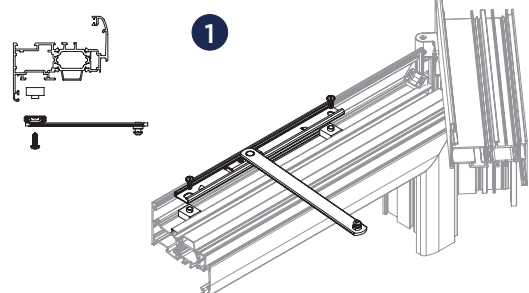

TELAIO | FRAME

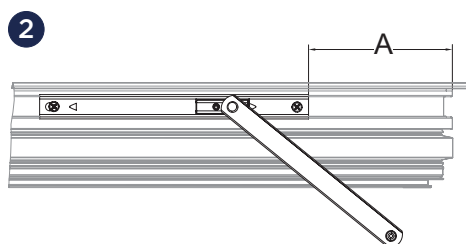

| ART. | Lunghezza Length | A | α |
|----------|--------------------|----|----------|
| 1203A.6 | 6" | 90 | 30° |
| 1203A.8 | 8" | 65 | 70° |
| 1203A.10 | 10" | 65 | 90° |

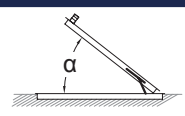

| $\alpha=10^\circ$ |
|-------------------|
| A |
| 160 |
| 210 |
| 240 |

ANTA | SASH

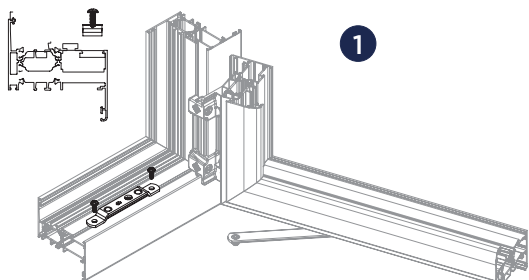

TELAIO | FRAME

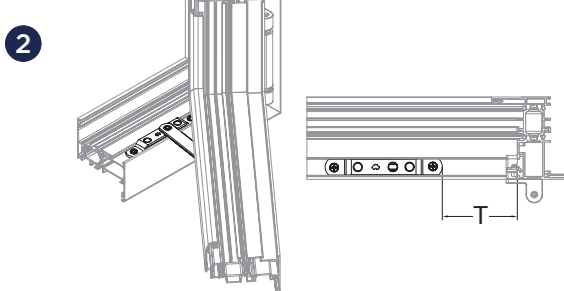

| ART. | Lunghezza Length | A | α |
|----------|--------------------|----|----------|
| 1203A.6 | 6" | 90 | 30° |
| 1203A.8 | 8" | 65 | 70° |
| 1203A.10 | 10" | 65 | 90° |

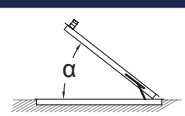

| $\alpha=10^\circ$ |
|-------------------|
| A |
| 160 |
| 210 |
| 240 |