

Video montaggio disponibile su MASTERTUBE  
Video mounting available on MASTERTUBE  
Video montage disponible sur MASTERTUBE



ITA

ENG

FRA

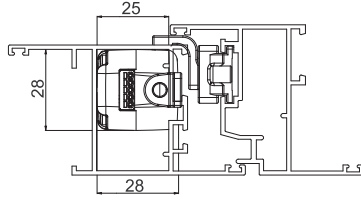

## Indicazioni di montaggio / Mounting Indication

Le dimensioni dell'attuatore e della serratura automatica permettono il montaggio solo su infissi con telaio maggiorato o con una tubolarità tale da poter contenere gli ingombri indicati nell'immagine.

The dimensions of the actuator and of the automatic lock permit the installation only on enlarged profiles or on tubular profiles that can comply with the dimensions indicated in the picture.

## Altri Accessori / Other accessories

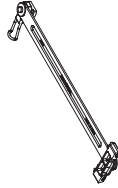
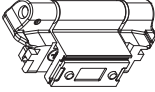
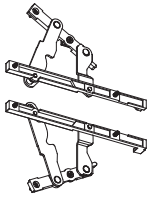
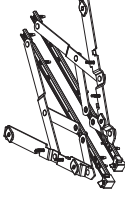
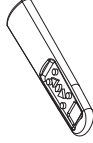
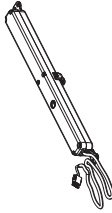
<p><b>1115.1 *</b></p> <p><b>IT</b> SIMPLE PLUS (limitatore di apertura) <b>EN</b> SIMPLE PLUS (opening limiter) <b>FR</b> SIMPLE PLUS (limiteur d'ouverture) <b>ES</b> SIMPLE PLUS (compas limitador de apertura)</p> <p><b>OBBLIGATORIO IN ABBINAMENTO CON LE 3550A.70 REQUIRED IN COMBINATION WITH 3550A.70</b></p> <p><b>1023/03</b></p> 	<p><b>3550A.70</b></p> <p><b>IT</b> CERNIERA A PETTINE <b>EN</b> COMB HINGE <b>FR</b> PAUMELLE A PEIGNE <b>ES</b> BISAGRAS DE TRES ALAS</p> 
<p><b>1023</b> : VEGADUE (cerniera vasistas a singola apertura) <b>1023</b> : VEGADUE (single opening transom hinges) <b>FR</b> : VEGADUE (charnière à ouverture simple) <b>ES</b> : VEGADUE (bisagra apertura Individual)</p> <p><b>1033</b> : VEGATRE (cerniera vasistas a doppia apertura) <b>1033</b> : VEGATRE (double opening transom hinges) <b>FR</b> : VEGATRE (charnière à ouverture double) <b>ES</b> : VEGATRE (bisagra de doble apertura)</p> 	<p><b>1231.12</b></p> <p><b>IT</b> EASY RAPID (cerniera a compasso) <b>EN</b> EASY RAPID (stay hinge) <b>FR</b> EASY RAPID (compas) <b>ES</b> EASY RAPID (compases)</p> 
<p><b>1121.50</b></p> 	<p><b>1121.2</b></p> <p><b>IT</b> WiCloud RC (Attuatore con logica) <b>EN</b> WiCloud RC (Actuator with logic) <b>FR</b> WiCloud RC (Actomneur avec logique) <b>ES</b> WiCloud RC (Actuador con lógica)</p> 

Per le portate dell'infisso fare riferimento alle indicazioni riguardanti gli accessori sopra indicati che si decide di utilizzare.  
For window load capacity, refer to indications on the above-mentioned accessories that you decide to use.

\* Il SIMPLE PLUS deve sempre essere libero dal suo riscontro di battuta anche quando l'anta è al massimo della sua apertura.  
Questo articolo funge solo da sicurezza nel caso di rottura catena.  
The SIMPLE PLUS should always be free from its abutment even when the door is at its maximum aperture.  
This article only serves as a safety in case of chain breakage.

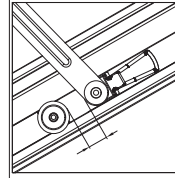

## NODO SECTION

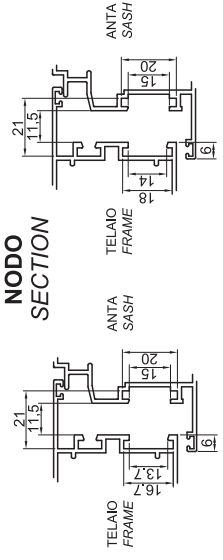

24V

1121.50

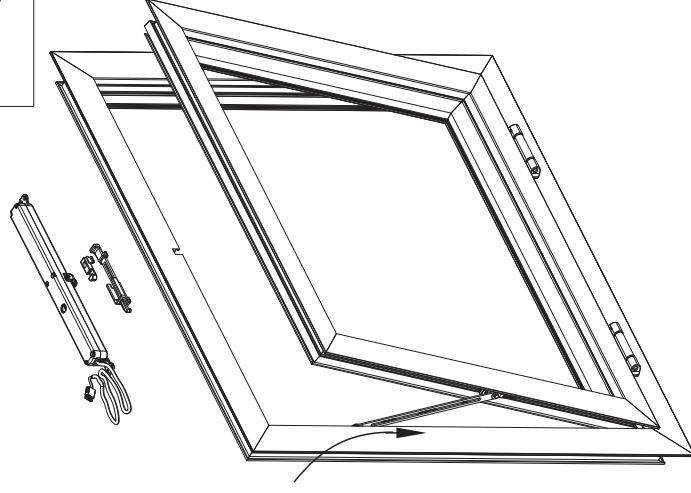
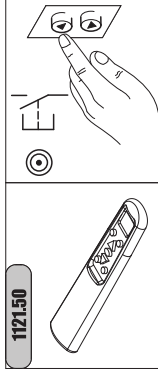

**MASTER**  
HARDWARE FOR WINDOWS AND DOORS

<http://www.masteritaly.com>

WiCloud RC

Per sistemi Camera Europea / For eurogroove system

Attuatore per Vasistas - Art. 1121.1  
Actuator for Vasistas - Art. 1121.1

<http://www.masteritaly.com>

**Istruzioni di montaggio / Mounting Instructions**

**TELAIO  
FRAME**

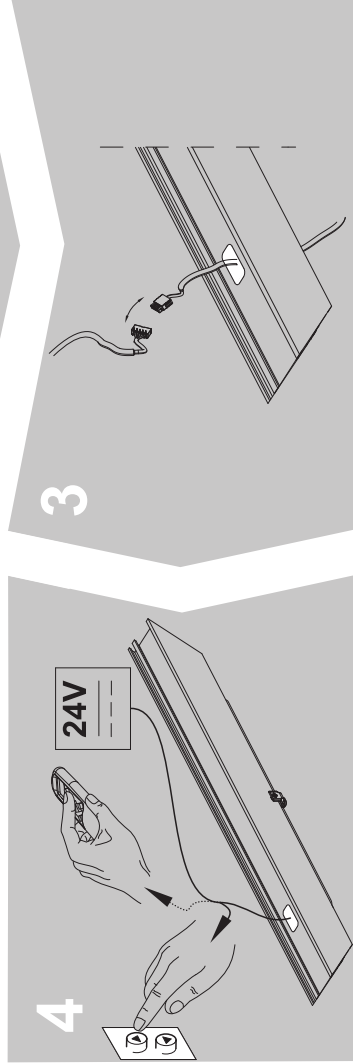
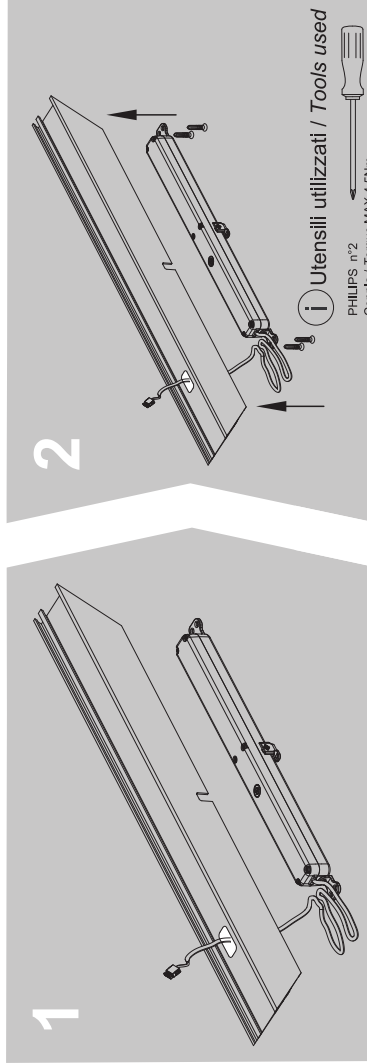
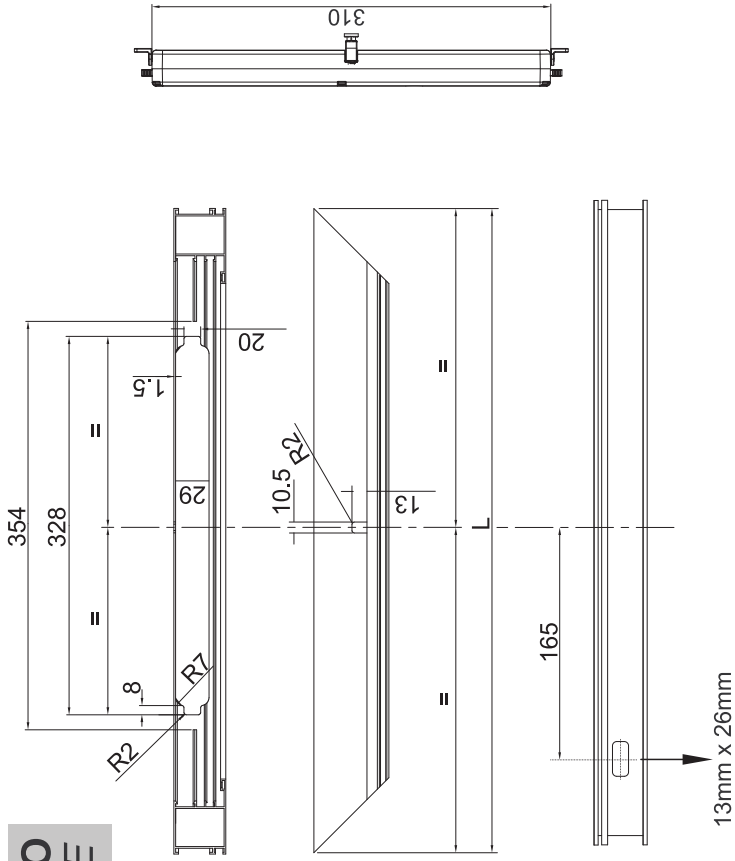

**ANTA  
SASH**

