

38

SERRATURE DA APPLICARE PER CILINDRO

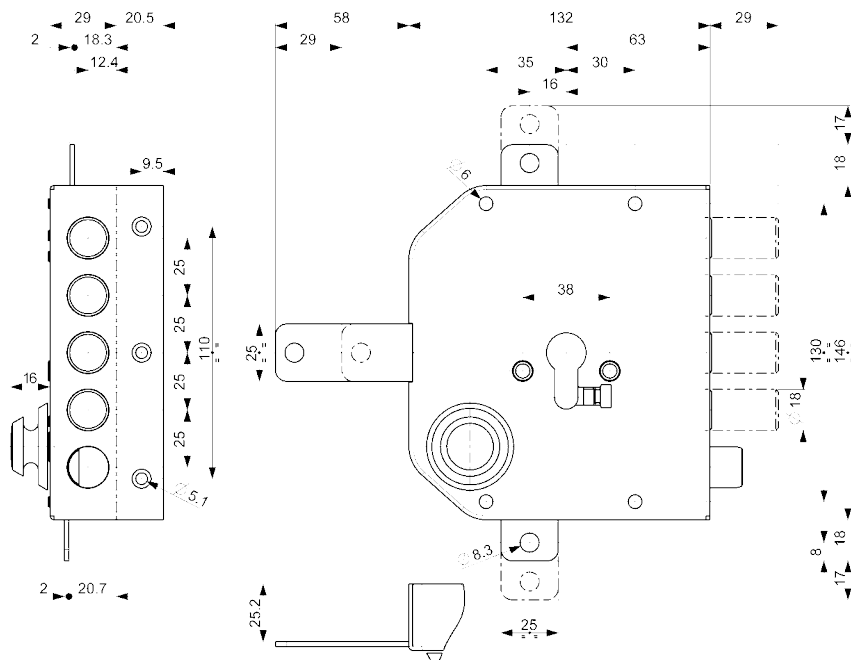

38.650

MADE
IN
ITALY**Caratteristiche**

- Serrature laterali, triplici o quintuplici
- Entrata cilindro mm 63
- Fissaggio del cilindro con "Attacco" Mottura
- Corsa chiavistelli mm 29
- Tutti gli articoli sono forniti destri e sinistri (specificare nell'ordine)
- Finitura: Verniciata

Avvertenza: in caso di sostituzione di serrature a pompa oppure doppia mappa con gli articoli 38.640 e 38.650 occorre utilizzare il deviatore art. 96.145 anziché l'art. 96.143. Per caratteristiche e disegni tecnici vedere capitolo **96**

Si raccomanda di utilizzare i kit Defender® per una maggiore protezione della serratura e del cilindro. Vedere capitolo **94**

ASTE, DEVIATORI, CILINDRO E ALTRI ACCESSORI NON SONO INCLUSI.**A richiesta:**

- Sistema di bloccaggio antieffrazione brevettato (estrazione del cilindro) **T** (aggiungere al codice serratura la lettera T)

SI RACCOMANDA di utilizzare cilindri di sicurezza CHAMPIONS.

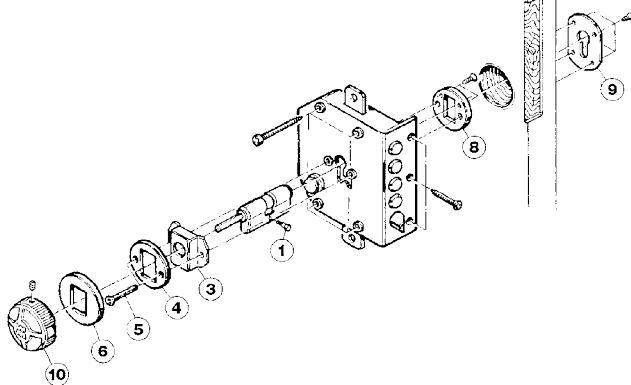
**ESEMPIO DI MONTAGGIO CON CHIAVE "PREDISPOSIZIONE POMOLO + CHIAVE"****Laterali - art. 38600/610**

- particolari fissaggio cilindro 1-3-4-5-6-8
- n. 1 mostrina (9) art. 95297/B
- n. 1 ferrogliera art. 94122
- viti e minuteria

Triplici - art. 38620/630

- particolari fissaggio cilindro 1-3-4-5-6-8
- n. 1 mostrina (9) art. 95297/B
- n. 1 ferrogliera art. 94122
- n. 2 passanti per aste art. 99152
- n. 1 cavallotto art. 99153
- n. 1 bocchetta a pavimento art. 99151
- viti e minuteria

Quintuplici - art. 38640/650







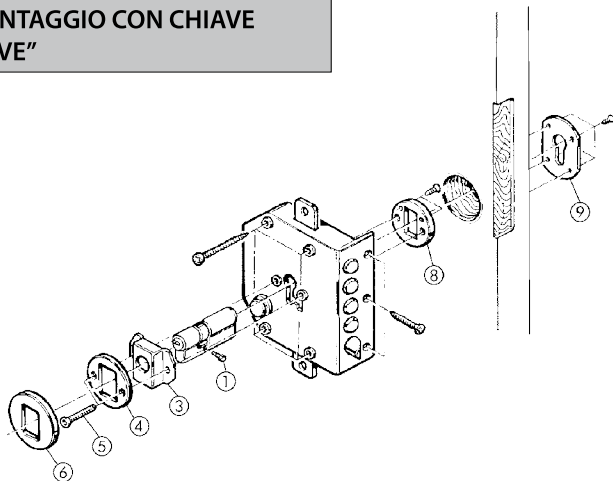











- particolari fissaggio cilindro 1-3-4-5-6-8
- n. 1 mostrina (9) art. 95297/B
- n. 1 ferrogliera art. 94122
- n. 2 passanti per aste art. 99152
- n. 1 cavallotto art. 99153
- n. 1 bocchetta a pavimento art. 99151
- viti e minuteria

Da richiedere a parte:

- cilindro
- protezione esterna del cilindro Defender® in sostituzione della piastrina di fissaggio (8)
- distanziale per defender art. 99256
- aste e deviatore

ESEMPIO DI MONTAGGIO CON CHIAVE "CHIAVE + CHIAVE"

A RICHIESTA
Sistema di bloccaggio
all'estrazione del cilindro

38.600..			
Versione	Prezzo €		
N - base			
T - antieffrazione 			
Laterale			
38.610..			
Versione	Prezzo €		
N - base			
T - antieffrazione 			
Laterale con mezzo giro			
38.620..		Aste NON comprese	
Versione	Prezzo €		
N - base			
T - antieffrazione 			
Triplice Corsa aste mm 17			
38.630..		Aste NON comprese	
Versione	Prezzo €		
N - base			
T - antieffrazione 			
Triplice con mezzo giro Corsa aste mm 17			
38.640..		Aste e deviatore NON compresi	
Versione	Prezzo €		
N - base			
T - antieffrazione 			
Quintuplice Corsa aste mm 17 Corsa quintuplice mm 29			
38.650..		Aste e deviatore NON compresi	
Versione	Prezzo €		
N - base			
T - antieffrazione 			
Quintuplice con mezzo giro Corsa aste mm 17 Corsa quintuplice mm 29			

95.442		
Finitura	Prezzo €	
Bronzata		
Mostrina interna 130 x 150 mm completa di viti per serrature serie 38 con mezzo giro. Conf. da 10 pezzi		

PER ACCESSORI E RICAMBI SERIE 38 VEDI CAPITOLI



ASTE

93**94**TESTIERE
FERROGLIERE

MOSTRINE

95**96**

DEVIATORI

RICAMBI
VARI**99**

40

SERRATURE DOPPIA MAPPA AD INFILARE

INFILARE





40.701

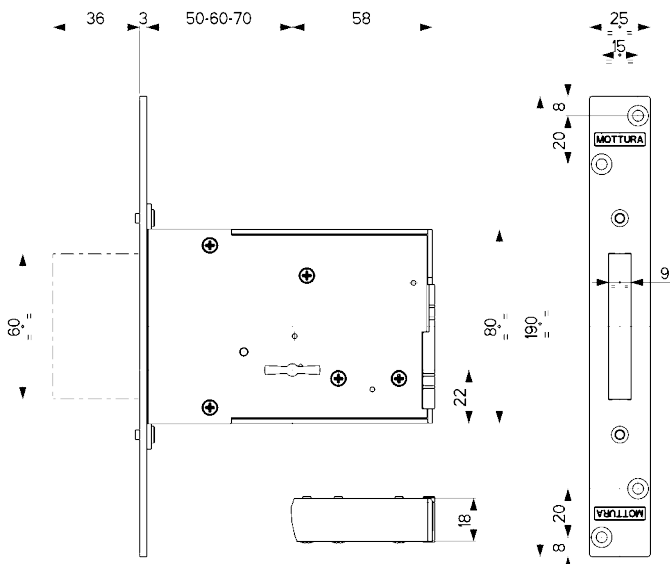

Caratteristiche

- Serrature ad infilare per infissi in legno e ferro
- Laterali
- Entrata chiave mm 50/60/70 specificare nell'ordine
- Tutti gli articoli sono ambidestri
- Finiture:
 - Scatola Zincata, Testiera Nichelata o Zincata
- Confezioni singole o multiple con serrature a:
 - cifratura diversa
 - cifratura uguale (KA)
- Tutte le confezioni comprendono, oltre agli accessori specificati, viti e minuteria.

Il prezzo degli articoli forniti a confezione è unitario, se non specificato diversamente nella tabella di prezzo.

Serrature fornite con :
1/2/3 chiavi gambo mm 36 art.92292/5

A richiesta le serrature

possono essere fornite con:

- chiavi gambo mm 40 art. 92113/5
- chiavi gambo mm 60 art. 92256/5



40.701

Dotazione:

- 3 chiavi mm 36 art. 92292/5
- coppia mostrine in ottone art. 95323/324
- ferrogliera art. 94282 (dim. 184x25x3 mm)



Finitura Testiera

Prezzo €

Nichelata

Laterale - Entrata chiave: 50/60/70

Corsa chiavistello mm 36

40.702

Dotazione:

- 2 chiavi mm 36 art. 92292/5 per ogni serratura
- mostrina in ferro art. 95281



Finitura Testiera

Prezzo €

Zincata

Laterale - Entrata chiave: 50/60/70

Corsa chiavistello mm 36

**Conf. da 6 pezzi
con cifratura diversa**

40.704

Dotazione:

- 1 chiave mm 36 art. 92292/5 per ogni serratura
- mostrina in ferro art. 95281



Finitura Testiera

Prezzo €

Zincata

Laterale - Entrata chiave: 50/60/70

Corsa chiavistello mm 36

Conf. da 10 pezzi in KA