

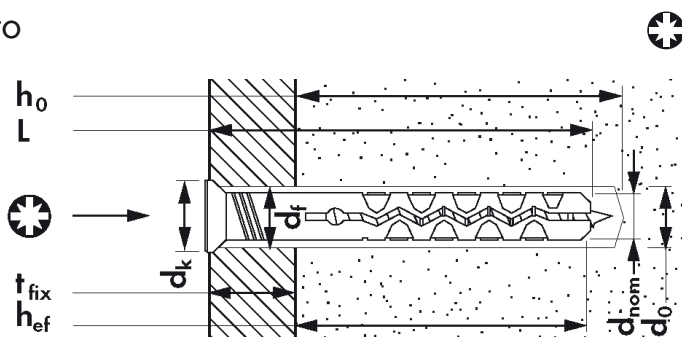

MNA-S Tassello a battuta con collare svasato



Materiale da costruzione



Certificazioni



Qualità Nylon
PA6

Zona d'espansione



La maggiorata lunghezza della zona d'espansione garantisce un'ottima tenuta.

Testa della vite rinforzata



Permette un'alta resistenza alla percussione e una maggiore resistenza agli sforzi di taglio.

Filettospeciale



Consente l'inserimento a percussione ed un facile svitamento.

Caratteristiche

- Installazione facile e veloce
- Acciaio inox per applicazioni all'esterno
- Tasselli prodotti con materie di primissima scelta, poliammide PA6
- Fissaggio passante

Applicazioni

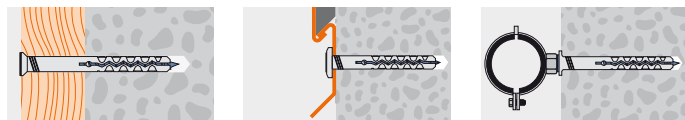

- costruzioni in legno
- battiscopa
- strutture di carpenteria
- serramenti e profili

Montaggio

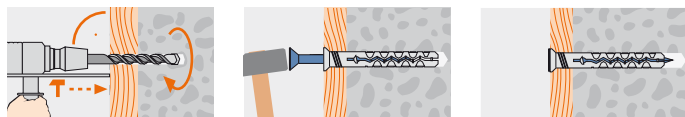

Forare

Inserire il tassello a percussione



MNA-S Tassello a battuta con collare svasato



Tipo	5 x 25 / 2	5 x 30 / 5	5 x 40 / 15	5 x 50 / 25	6 x 35 / 5	6 x 40 / 10	6 x 50 / 20	6 x 60 / 30	6 x 70 / 40	6 x 80 / 50	8 x 50 / 10	8 x 60 / 20	8 x 80 / 40	8 x 100 / 60	8 x 120 / 80	8 x 140 / 100
Ø Tassello e foro mm d_{nom}	5				6						8					
Lungh. tassello mm L	25	30	40	50	35	40	50	60	70	80	50	60	80	100	120	140
Ø Collare mm d_k	7				9						12					
Spessore utile mm t_{fix}	2	5	15	25	5	10	20	30	40	50	10	20	40	60	80	100
Profondità foro mm h_o	30				35						50					
Profondità min. di inserimento mm h_{et}	25				30						40					
Impronta	PZ2										PZ3					
Diametro del foro nel particolare da fissare mm d_f	5				6						8					
Calcestruzzo C20/25, carico a trazione (kN)	0.25				0.3						0.4					
Mattone pieno, trazione (kN)	0.2				0.25						0.3					
Pietra calcarea, trazione (kN)	0.15				0.2						0.25					
Pezzi per confezione	100															
Pezzi per imballo	2400				1800			1200			900			600		
Quantità per bancale	144000				108000			72000			54000			36000		
Codice articolo	1122502S	1122503S	1122504S	1122505S	1122603S	1122604S	1122605S	1122606S	1122607S	1122608S	1122805S	1122806S	1122808S	1122810S	1122812S	1122814S

Coefficiente di sicurezza $5 / 1 \text{ kN} \approx 100 \text{ kg}$



MNA-S Tassello a battuta con collare svasato con vite t.s.p. - non pre-assemblato

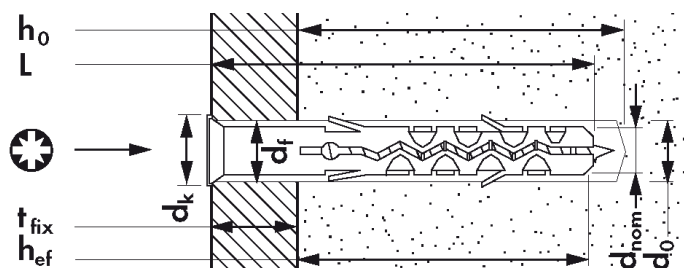
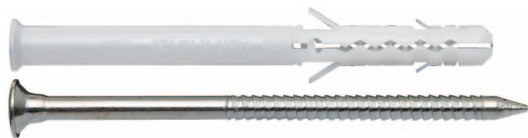

Materiale da costruzione



Certificazioni



Qualità Nylon
PA6

Zona d'espansione



La maggiorata lunghezza della zona d'espansione garantisce un'ottima tenuta.

Testa della vite rinforzata



Permette un'alta resistenza alla percussione e una maggiore resistenza agli sforzi di taglio.

Filetto speciale



Consente l'inserimento a percussione ed un facile svitamento.

Caratteristiche

- Installazione facile e veloce
- Acciaio inox per applicazioni all'esterno
- Tasselli prodotti con materie di primissima scelta, poliammide PA6
- Fissaggio passante

Applicazioni

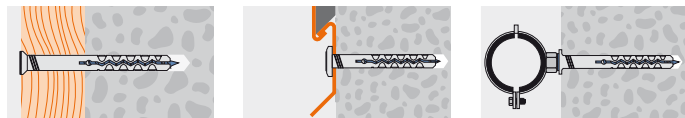

- costruzioni in legno
- battiscopa
- strutture di carpenteria
- serramenti e profili

Montaggio

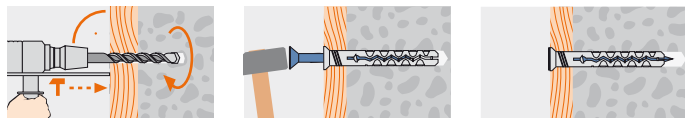

Forare

Inserire il tassello a percussione



MNA-S Tassello a battuta con collare svasato con vite t.s.p. - non pre-assemblato



Tipo	10 x 80 / 30	10 x 100 / 50	10 x 120 / 70	10 x 140 / 90	10 x 160 / 110
Ø Tassello e foro mm d_{nom}			10		
Lungh. tassello mm L	80	100	120	140	160
Ø Collare mm d_t			13		
Spessore utile mm t_{fix}	30	50	70	90	110
Profondità foro mm h_o			60		
Profondità min. di inserimento mm h_{ef}			50		
Impronta			PZ3		
Diametro del foro nel particolare da fissare mm d_t			10		
Calcestruzzo C20/25, carico a trazione (kN)			0.5		
Mattone pieno, trazione (kN)			0.4		
Pietra calcarea, trazione (kN)			0.3		
Pezzi per confezione			50		
Pezzi per imballo	600		300		
Quantità per bancale	36000		18000		
Codice articolo	11229081S	11229101S	11229121S	11229141S	11229161S

chiodo non premontato / Coefficiente di sicurezza 5 / 1 kN ≈ 100 kg



MNA-Z Tassello a battuta con collare piatto

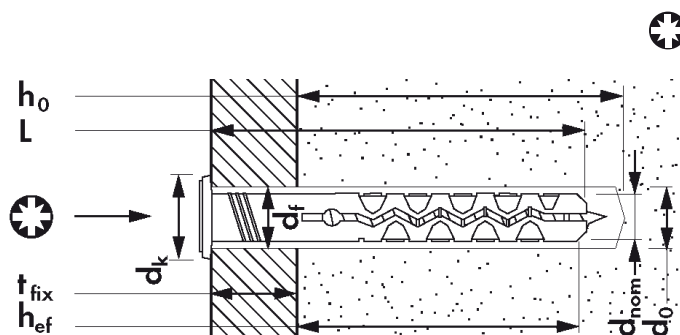

Materiale da costruzione



Calcestruzzo C20/25



Mattone pieno



Mattone pieno in
pietra arenaria



Mattone forato



Pietra naturale

Certificazioni



Qualità Nylon
PA6



Zona d'espansione



La maggiorata lunghezza della zona d'espansione garantisce un'ottima tenuta.

Testa della vite rinforzata



Permette un'alta resistenza alla percussione e una maggiore resistenza agli sforzi di taglio.

Filettospeciale



Consente l'inserimento a percussione ed un facile svitamento.

Caratteristiche

- Installazione facile e veloce
- Acciaio inox per applicazioni all'esterno
- Tasselli prodotti con materie di primissima scelta, poliammide PA6
- Fissaggio passante

Applicazioni

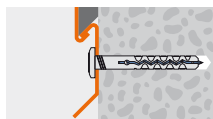
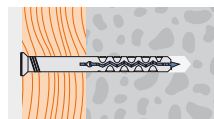

- costruzioni in legno
- battiscopa
- strutture di carpenteria
- serramenti e profili

Montaggio

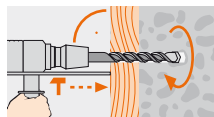

Forare

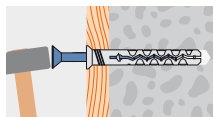

Inserire il tassello a percussione

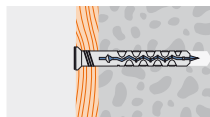



MNA-Z Tassello a battuta con collare piatto



Tipo	5 x 25 / 2				5 x 30 / 5				5 x 40 / 15				5 x 50 / 25				6 x 35 / 5				6 x 40 / 10				6 x 50 / 20				6 x 60 / 30				6 x 70 / 40				6 x 80 / 50				8 x 50 / 10				8 x 60 / 20				8 x 80 / 40				8 x 100 / 60				8 x 120 / 80				8 x 140 / 100																			
Ø Tassello e foro mm d_{nom}	5																6																8																																															
Lungh. tassello mm L	25	30	40	50	35	40	50	60	70	80	50	60	80	100	120	140	25	30	40	50	35	40	50	60	70	80	50	60	80	100	120	140	25	30	40	50	35	40	50	60	70	80	50	60	80	100	120	140																																
Ø Collare mm d_c	8																12																15																																															
Spessore utile mm t_{fix}	2	5	15	25	5	10	20	30	40	50	10	20	40	60	80	100	2	5	15	25	5	10	20	30	40	50	10	20	40	60	80	100	2	5	15	25	5	10	20	30	40	50	10	20	40	60	80	100																																
Profondità foro mm h_o	30																35																50																																															
Profondità min. di inserimento mm h_{ef}	25																30																40																																															
Impronta	PZ2																PZ3																																																															
Diametro del foro nel particolare da fissare mm d_f	5																6																8																																															
Calcestruzzo C20/25, carico a trazione (kN)	0.25																0.3																0.4																																															
Mattone pieno, trazione (kN)	0.2																0.25																0.3																																															
Pietra calcarea, trazione (kN)	0.15																0.2																0.25																																															
Pezzi per confezione	100																																																																															
Pezzi per imballo	2400				1800				1200				900				600				2400				1800				1200				900				600																																											
Quantità per bancale	144000																108000																72000																54000																36000															
Codice articolo	1122502Z	1122503Z	1122504Z	1122505Z	1122603Z	1122604Z	1122605Z	1122606Z	1122607Z	1122608Z	1122805Z	1122806Z	1122808Z	1122810Z	1122812Z	1122814Z	1122502Z	1122503Z	1122504Z	1122505Z	1122603Z	1122604Z	1122605Z	1122606Z	1122607Z	1122608Z	1122805Z	1122806Z	1122808Z	1122810Z	1122812Z	1122814Z	1122502Z	1122503Z	1122504Z	1122505Z	1122603Z	1122604Z	1122605Z	1122606Z	1122607Z	1122608Z	1122805Z	1122806Z	1122808Z	1122810Z	1122812Z	1122814Z																																

Coefficiente di sicurezza $5 / 1 \text{ kN} \approx 100 \text{ kg}$



MNA-G Tassello a battuta con grande collare piatto PZ2

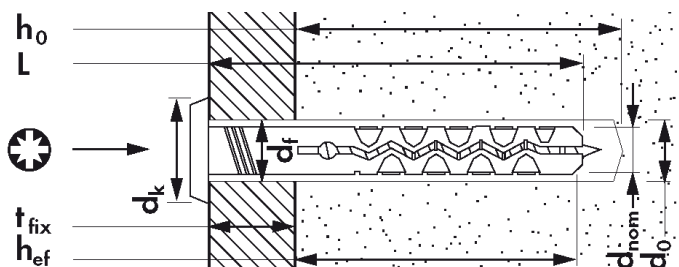

Materiale da costruzione



Calcestruzzo C20/25



Mattone pieno



Mattone pieno in
pietra arenaria



Mattone forato



Pietra naturale

Certificazioni



Qualità Nylon
PA6



Zona d'espansione



La maggiorata lunghezza della zona d'espansione garantisce un'ottima tenuta.

Testa della vite rinforzata



Permette un'alta resistenza alla percussione e una maggiore resistenza agli sforzi di taglio.

Filetto speciale



Consente l'inserimento a percussione ed un facile svitamento.

Caratteristiche

- Installazione facile e veloce
- Acciaio inox per applicazioni all'esterno
- Tasselli prodotti con materie di primissima scelta, poliammide PA6
- Fissaggio passante

Applicazioni

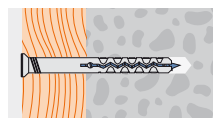

- costruzioni in legno
- battiscopa
- strutture di carpenteria
- serramenti e profili

Montaggio

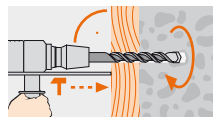

Forare

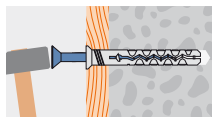

Inserire il tassello a percussione

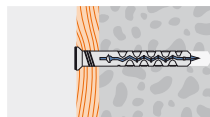



MNA-G Tassello a battuta con grande collare piatto PZ2



Tipo	5 x 25 / 2	5 x 30 / 5	5 x 40 / 15	6 x 40 / 10
Ø Tassello e foro mm d_{nom}		5		6
Lungh. tassello mm L	25	30	40	
Ø Collare mm d_k		11		13
Spessore utile mm t_{fix}	2	5	15	10
Profondità foro mm h_0		30		35
Profondità min. di inserimento mm h_{ef}		25		30
Impronta	PZ2			
Diametro del foro nel particolare da fissare mm d_f		5		6
Calcestruzzo C20/25, carico a trazione (kN)		0.25		0.3
Mattone pieno, trazione (kN)		0.2		0.25
Pietra calcarea, trazione (kN)		0.15		0.2
Pezzi per confezione	100			
Pezzi per imballo		2400		1800
Quantità per bancale		57600		43200
Codice articolo	1122502G	1122503G	1122504G	1122604G

Coefficiente di sicurezza 5 / 1 kN \approx 100 kg



MNA-G Tassello a battuta con grande collare piatto T25

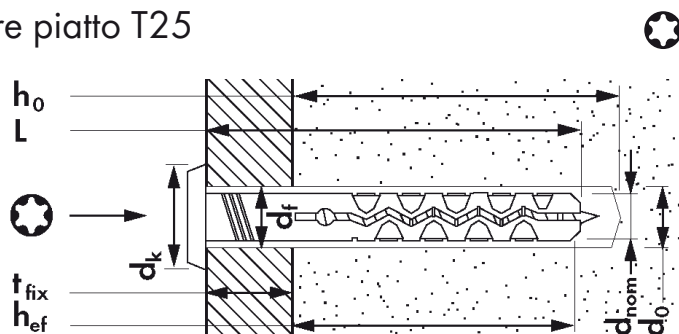

Materiale da costruzione



Calcestruzzo C20/25



Mattone pieno



Mattone pieno in
pietra arenaria



Mattone forato



Pietra naturale

Certificazioni



Qualità Nylon
PA6



Zona d'espansione



La maggiorata lunghezza della zona d'espansione garantisce un'ottima tenuta.

Testa della vite rinforzata



Permette un'alta resistenza alla percussione e una maggiore resistenza agli sforzi di taglio.

Filetto speciale



Consente l'inserimento a percussione ed un facile svitamento.

Caratteristiche

- Installazione facile e veloce
- Acciaio inox per applicazioni all'esterno
- Tasselli prodotti con materie di primissima scelta, poliammide PA6
- Fissaggio passante

Applicazioni

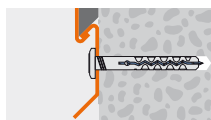
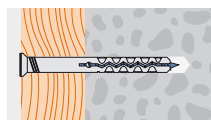

- costruzioni in legno
- battiscopa
- strutture di carpenteria
- serramenti e profili

Montaggio

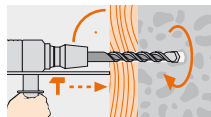

Forare

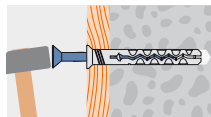

Inserire il tassello a percussione

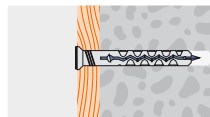



MNA-G Tassello a battuta con grande collare piatto T25



Tipo	8 x 50 / 10	8 x 60 / 20	8 x 80 / 40	8 x 100 / 60
Ø Tassello e foro mm d_{nom}	8			
Lungh. tassello mm L	50	60	80	100
Ø Collare mm d_k	17			
Spessore utile mm t_{fix}	10	20	40	60
Profondità foro mm h_0	50			
Profondità min. di inserimento mm h_{ef}	40			
Impronta	T25			
Diametro del foro nel particolare da fissare mm d_f	8			
Calcestruzzo C20/25, carico a trazione (kN)	0.4			
Mattone pieno, trazione (kN)	0.3			
Pietra calcarea, trazione (kN)	0.25			
Pezzi per confezione	100			
Pezzi per imballo	900		600	
Quantità per bancale	21600		14400	
Codice articolo	1122805G	1122806G	1122808G	1122810G

Coefficiente di sicurezza $5 / 1 \text{ kN} \approx 100 \text{ kg}$



MNA^m Tassello in nylon con vite a chiodo premontata

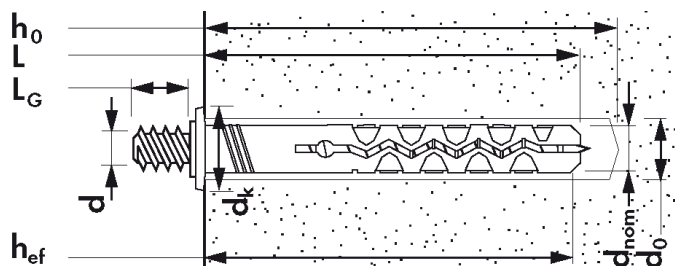

Materiale da costruzione



Calcestruzzo C20/25



Mattone pieno



Mattone pieno in
pietra arenaria



Mattone forato



Pietra naturale

Certificazioni



Qualità Nylon
PA6



Zona d'espansione



La maggiorata lunghezza della zona d'espansione garantisce un'ottima tenuta.

Testa della vite rinforzata



Permette un'alta resistenza alla percussione e una maggiore resistenza agli sforzi di taglio.

Filettospeciale



Consente l'inserimento a percussione ed un facile svitamento.

Caratteristiche

- Installazione facile e veloce
- Acciaio inox per applicazioni all'esterno
- Tasselli prodotti con materie di primissima scelta, poliammide PA6
- Fissaggio passante

Applicazioni

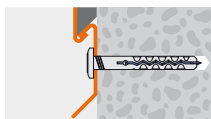
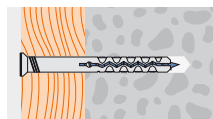

- costruzioni in legno
- battiscopa
- strutture di carpenteria
- serramenti e profili

Montaggio

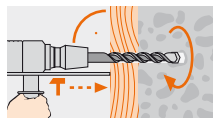

Forare

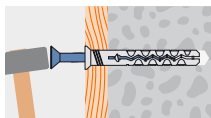

Inserire il tassello a percussione

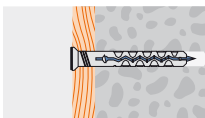



MNA^m Tassello in nylon con vite a chiodo premontata

Tipo	6 x 35	8 x 60
Filetto d	M6	M8
Lunghezza filetto mm l_G	8	7
Ø Tassello e foro mm d_{nom}	6	8
Lungh. tassello mm L	35	60
Profondità foro mm h_o	40	70
Ø Collare mm d_k	12	
Profondità min. di inserimento mm h_{ef}	35	60
Calcestruzzo C20/25, carico a trazione (kN)	0.5	0.6
Mattoni pieni, trazione (kN)	0.4	0.5
Pietra calcarea, trazione (kN)	0.3	0.4
Pezzi per confezione	100	
Pezzi per imballo	1800	900
Quantità per bancale	43200	21600
Codice articolo	11226035	11228065

Coefficiente di sicurezza 5 / 1 kN ≈ 100 kg



MNAr-S Tassello a battuta con collare svasato, vite inox A2

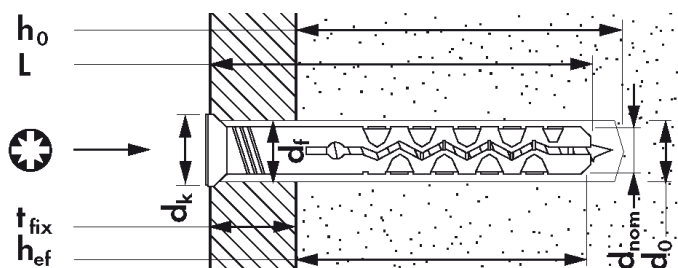

Materiale da costruzione



Calcestruzzo C20/25



Mattone pieno



Mattone pieno in pietra arenaria



Mattone forato



Pietra naturale

Certificazioni



Qualità Nylon PA6



Zona d'espansione



La maggiorata lunghezza della zona d'espansione garantisce un'ottima tenuta.

Testa della vite rinforzata



Permette un'alta resistenza alla percussione e una maggiore resistenza agli sforzi di taglio.

Filettospeciale



Consente l'inserimento a percussione ed un facile svitamento.

Caratteristiche

- Installazione facile e veloce
- Acciaio inox per applicazioni all'esterno
- Tasselli prodotti con materie di primissima scelta, poliammide PA6
- Fissaggio passante

Applicazioni

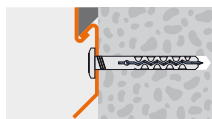
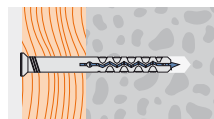

- costruzioni in legno
- battiscopa
- strutture di carpenteria
- serramenti e profili

Montaggio

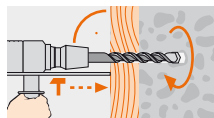

Forare

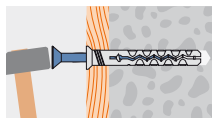

Inserire il tassello a percussione

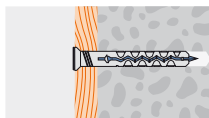



MNAr-S Tassello a battuta con collare svasato, vite inox A2



Tipo	5 x 30 / 5		5 x 50 / 25		6 x 35 / 5		6 x 40 / 10		6 x 50 / 20		6 x 60 / 30		6 x 70 / 40		8 x 50 / 10		8 x 60 / 20		8 x 80 / 40		8 x 100 / 60		8 x 120 / 80		8 x 140 / 100							
Ø Tassello e foro mm d_{nom}	5				6								8																			
Lungh. tassello mm L	30	50	35	40	50	60	70	50	60	80	100	120	140																			
Ø Collare mm d_t	7				9								12																			
Spessore utile mm t_{fix}	5	25	5	10	20	30	40	10	20	40	60	80	100																			
Profondità foro mm h_o	30				35								50																			
Profondità min. di inserimento mm h_{ef}	25				30								40																			
Impronta	PZ2												PZ3																			
Diametro del foro nel particolare da fissare mm d_t	5				6								8																			
Calcestruzzo C20/25, carico a trazione (kN)	0.25				0.3								0.4																			
Mattone pieno, trazione (kN)	0.2				0.25								0.3																			
Pietra calcarea, trazione (kN)	0.15				0.2								0.25																			
Pezzi per confezione	100																															
Pezzi per imballo	2400				1800								1200								900						600					
Quantità per bancale	57600				43200								28800								21600						14400					
Codice articolo	1125503S	1125505S	1125603S	1125604S	1125605S	1125606S	1125607S	1125805S	1125806S	1125808S	1125810S	1125812S	1125814S																			

Coefficiente di sicurezza $5 / 1 \text{ kN} \approx 100 \text{ kg}$



MNAr-Z Tassello a battuta con collare piatto, vite inox A2

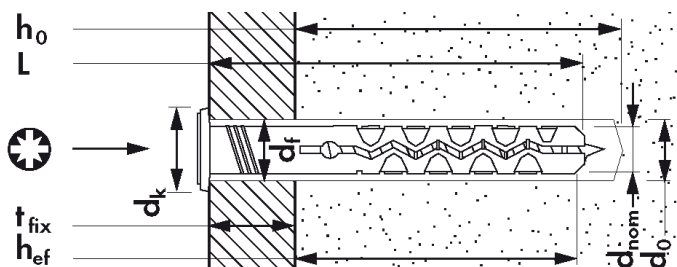

Materiale da costruzione



Certificazioni



Zona d'espansione



La maggiorata lunghezza della zona d'espansione garantisce un'ottima tenuta.

Testa della vite rinforzata



Permette un'alta resistenza alla percussione e una maggiore resistenza agli sforzi di taglio.

Filetto speciale



Consente l'inserimento a percussione ed un facile svitamento.

Caratteristiche

- Installazione facile e veloce
- Acciaio inox per applicazioni all'esterno
- Tasselli prodotti con materie di primissima scelta, poliammide PA6
- Fissaggio passante

Applicazioni



- costruzioni in legno
- battiscopa
- strutture di carpenteria
- serramenti e profili

Montaggio

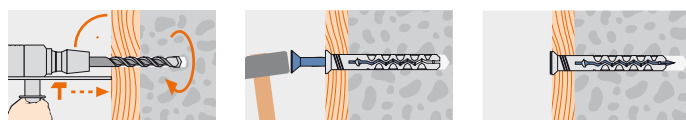

Forare

Inserire il tassello a percussione



MNAr-Z Tassello a battuta con collare piatto, vite inox A2



Tipo	5 x 30 / 5		5 x 50 / 25		6 x 35 / 5		6 x 40 / 10		6 x 50 / 20		6 x 60 / 30		6 x 70 / 40		8 x 50 / 10		8 x 60 / 20		8 x 80 / 40		8 x 100 / 60		8 x 120 / 80		8 x 140 / 100	
Ø Tassello e foro mm d_{nom}	5				6								8													
Lungh. tassello mm L	30	50	35	40	50	60	70	50	60	80	100	120	140													
Ø Collare mm d_k	8				12								15													
Spessore utile mm t_{fix}	5	25	5	10	20	30	40	10	20	40	60	80	100													
Profondità foro mm h_o	30				35								50													
Profondità min. di inserimento mm h_{ef}	25				30								40													
Impronta	PZ2												PZ3													
Diametro del foro nel particolare da fissare mm d_f	5				6								8													
Calcestruzzo C20/25, carico a trazione (kN)	0.25				0.3								0.4													
Mattone pieno, trazione (kN)	0.2				0.25								0.3													
Pietra calcarea, trazione (kN)	0.15				0.2								0.25													
Pezzi per confezione	100																									
Pezzi per imballo	2400				1800				1200				900				600									
Quantità per bancale	57600				43200				28800				21600				14400									
Codice articolo	1125503Z	1125505Z	1125603Z	1125604Z	1125605Z	1125606Z	1125607Z	1125805Z	1125806Z	1125808Z	1125810Z	1125812Z	1125814Z													

Coefficiente di sicurezza 5 / 1 kN ≈ 100 kg