

Codice Articolo
Article Number

0117

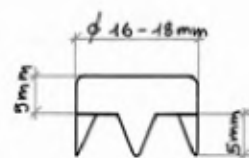

Copridado metallo.
FINITURA:
ferro zincato,
ferro tropicalizzato.
MISURA:
Ø mm. 16,
Ø mm. 18.
CONFEZIONE:
pz. 1.000

Codice Articolo
Article Number

0518



A	5	6	8	10
B	7	9	15	17
C	6	6	7	8
D	1	2	2	2

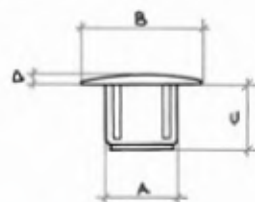

Copriforo plastica.
COLORE: bianco,
marrone, nero.
MISURA E
CONFEZIONE:
Ø mm. 5 pz. 5.000
Ø mm. 6 pz. 5.000
Ø mm. 8 pz. 1.000
Ø mm. 10 pz. 1.000

Codice Articolo
Article Number

0297

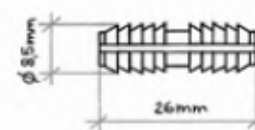

Spina plastica
per congiunzione
mobili.
CONFEZIONE:
pz. 1.000

Codice Articolo
Article Number

0131



A	Ø 16	Ø 19
B	8	8
C	5,5	7,5

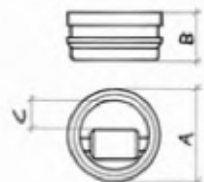

Pozzetto a rullo
ottone tornito.
FINITURA: ottone
lucido.
MISURA: Ø mm. 16,
Ø mm. 19.
CONFEZIONE: pz. 250

Codice Articolo
Article Number

0265



A	6	8	9	10	11
B	10	12	13	14	15
A	12	13	14	15	16
B	16	17	18	19	20

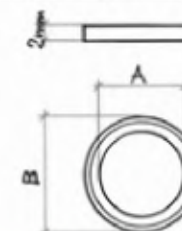

Rondella alzaporta
ottone tornito
spessore mm. 2.
FINITURA: ottone
lucido.
MISURA: Ø mm. 6,
Ø mm. 8, Ø mm. 9,
Ø mm. 10, Ø mm. 11,
Ø mm. 12, Ø mm. 13,
Ø mm. 14, Ø mm. 15,
Ø mm. 16.
CONFEZIONE:
pz. 1.000

Codice Articolo
Article Number

0138



A	Ø 10	Ø 12	Ø 14	Ø 16	Ø 18
B	Ø 4,2	Ø 5	Ø 5,5	Ø 6,4	Ø 7
C	2	2,4	2,4	2,7	2,7

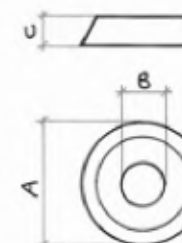

Orli sottovite.
FINITURA: ferro
ottonato, ferro
nichelato.
MISURA: Ø mm. 10mm
Ø mm. 12, Ø mm. 14,
Ø mm. 16, Ø mm. 18.
CONFEZIONE:
pz. 1.000

Codice Articolo
Article Number

0179



A	Ø 22	Ø 32	Ø 42
B	7	6	6
C	Ø 28	Ø 37	Ø 46

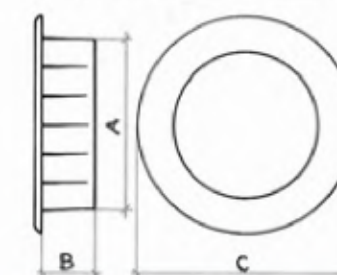

Maniglia plastica
tonda ad incasso
per scorrevoli.
COLORE: bianco,
marrone, nero.
MISURA E
CONFEZIONE:
Ø mm. 22 pz. 500
Ø mm. 35 pz. 200
Ø mm. 45 pz. 200

Codice Articolo
Article Number

0180

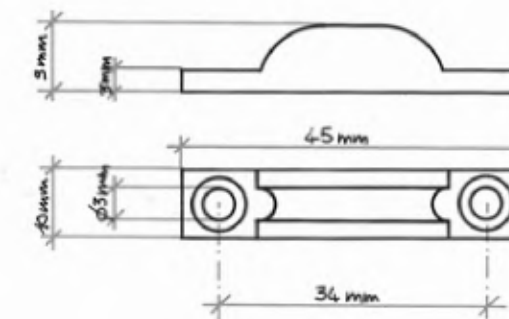

Pattino plastica
per scorrevoli.
COLORE: bianco,
marrone, avorio.
CONFEZIONE: pz. 500