

Codice Articolo
Article Number

0137

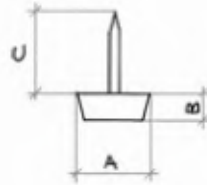

A	12	14	17	20	24
B	6	6	6	6	6
C	14	14	14	14	14



Sottosedia plastica
con falsa vite.
COLORE: bianco,
marrone, nero.
MISURA E
CONFEZIONE:
Ø mm. 12 pz. 1.000
Ø mm. 14 pz. 1.000
Ø mm. 17 pz. 1.000
Ø mm. 20 pz. 1.000
Ø mm. 24 pz. 500

Codice Articolo
Article Number

0437



A	15	22	28
B	6	6	6
C	14	14	14

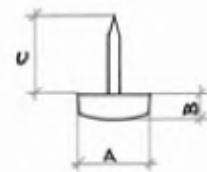

Scivolo plastica liscio
con falsa vite.
COLORE: bianco,
marrone.
MISURA E
CONFEZIONE:
Ø mm. 15 pz. 1.000
Ø mm. 22 pz. 1.000
Ø mm. 28 pz. 500

Codice Articolo
Article Number

0165



A	30	30	40	40
B	M.8	M.10	M.8	M.10
C	37	36	32	37
D	20	20	20	20

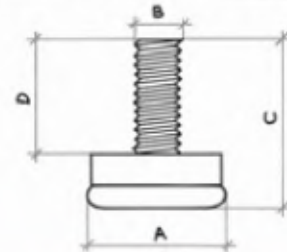

Scivolo silenzioso
acciaio con vite.
FINITURA: nichelato.
MISURA: Ø mm. 30,
Ø mm. 40xM.8,
Ø mm. 30,
Ø mm. 40xM.10.
CONFEZIONE: pz. 200

Codice Articolo
Article Number

0187

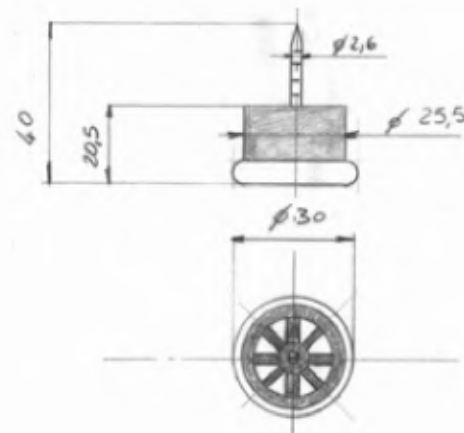

Scivolo acciaio doppia
altezza Ø mm. 30.
COLORE: nero.
CONFEZIONE: pz. 100

Codice Articolo
Article Number

0435



A	14	16	18	20
B	4,2	4	4,7	5,2
C	13,5	13,5	13,8	14,3

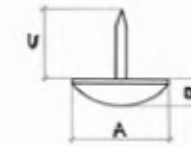

Scivolo silenzioso
metallo con punta.
FINITURA:
ferro lucido,
ferro nichelato.
MISURA E
CONFEZIONE:
Ø mm. 14 pz. 1.000,
Ø mm. 16 pz. 1.000,
Ø mm. 18 pz. 1.000,
Ø mm. 20 pz. 500

Codice Articolo
Article Number

0183



A	15	18	20	23	26	30	40
B	8	9	10	11	11	12	12
C	16	17	17	15	20	20	20

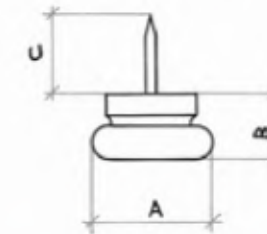

Scivolo silenzioso
acciaio con falsa vite.
FINITURA: nichelato.
MISURA E
CONFEZIONE:
Ø mm. 15 pz. 500,
Ø mm. 18 pz. 500,
Ø mm. 20 pz. 350,
Ø mm. 23 pz. 250,
Ø mm. 26 pz. 150,
Ø mm. 30 pz. 125,
Ø mm. 40 pz. 60

Codice Articolo
Article Number

0185



A	18	23	30
B	9	11	12
C	17	15	20

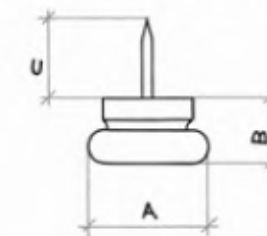

Scivolo silenzioso
nylon con falsa vite.
COLORE: marrone.
MISURA E
CONFEZIONE:
Ø mm. 18 pz. 500
Ø mm. 23 pz. 250
Ø mm. 30 pz. 125

Codice Articolo
Article Number

0439



A	22	26	30
B	10	10	10
C	18	18	18

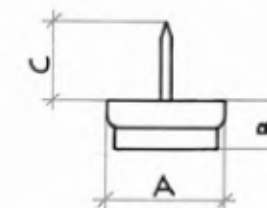

Scivolo plastica
con falsa vite e base
in feltro.
COLORE:
bianco, marrone.
MISURA: Ø mm. 22,
Ø mm. 26, Ø mm. 30.
CONFEZIONE: pz. 200