



TOP SPIN

CERNIERA A PETTINE IN ALLUMINIO ESTRUSO



Cerniera a pettine in alluminio estruso | Comb hinge in extruded aluminium | Paumelle a peigne en aluminium extrudé | Bisagras de tres alas de aluminio extruido



Cerniera lato telaio e lato anta in alluminio estruso, piastrine in zama, boccole e tappini in nylon, viti, perno grano in acciaio inox.



Frame side and shutter side in extruded aluminium, zamak plates, nylon bushings and caps, stainless steel screws and pin.



Paumelle côté dormant et côté ouvrant en aluminium extrudé, plaques en zamak, bagues et bouchons en nylon, vis et pivot en acier inox.



Bisagra del lado del marco y de la hoja de aluminio extruido, placas de zamak, casquillos y tapones de nylon, tornillos y pernio de acero inox.



ART.	TUTTI ALL TOUS TODOS
Imballo Package Conditionnement Embalaje	10 PZ
Finiture disponibili Available finishes Finitions disponibles Acabados disponibles	1 2 3 4

Art. 3420.71 | 3420.72 | 3421.72

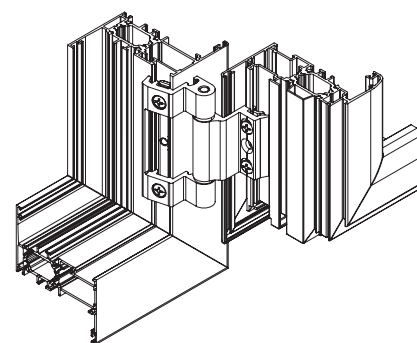
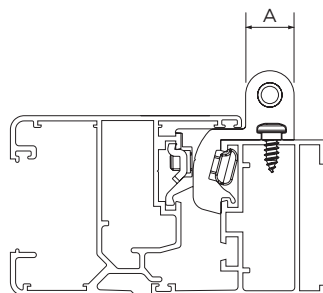
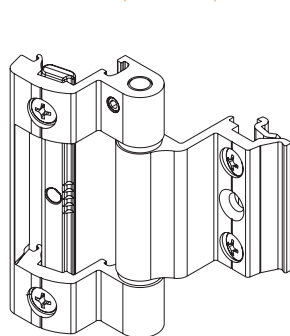

DESCRIZIONE DESCRIPTION	ART	NODO SECTION	A
Cerniera a pettine in alluminio estruso Comb hinge in extruded aluminium	3420.71	A03	15
Cerniera a pettine in alluminio estruso Comb hinge in extruded aluminium	3420.72	A01 - A05	15
Cerniera a pettine in alluminio estruso Comb hinge in extruded aluminium	3421.72	A08	15

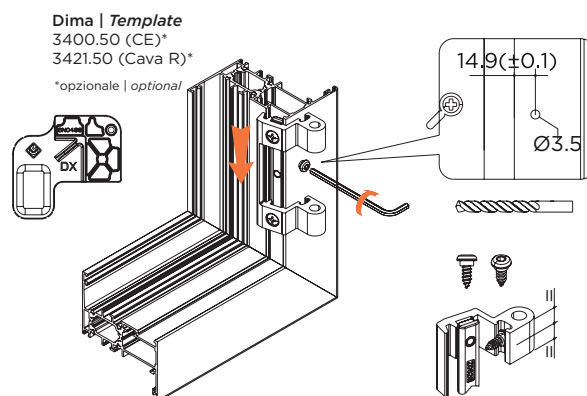



BATTENTE CASEMENT

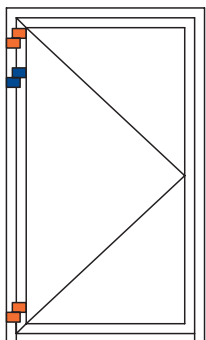

	2800	100%	100%	100%	100%	100%	100%	100%	100%	
	2700	100%	100%	100%	100%	100%	100%	100%	100%	
	2600	100%	100%	100%	100%	100%	100%	100%	100%	
	2500	100%	100%	100%	100%	100%	100%	100%	100%	
	2400	100%	100%	100%	100%	100%	100%	100%	100%	
	2300	100%	100%	100%	100%	100%	100%	100%	100%	
	2200	100%	100%	100%	100%	100%	100%	100%	97%	
	2100	100%	100%	100%	100%	100%	100%	100%	90%	
	2000	100%	100%	100%	100%	100%	100%	94%	83%	
	1900	100%	100%	100%	100%	100%	98%	86%	76%	
	1800	100%	100%	100%	100%	100%	90%	78%	69%	
	1700	100%	100%	100%	100%	100%	95%	82%	71%	
	1600	100%	100%	100%	100%	100%	85%	73%	63%	
	1500	100%	100%	100%	100%	90%	76%	65%	55%	
	1400	100%	100%	100%	96%	80%	67%	57%	N.D.	
	1300	100%	100%	100%	84%	70%	58%	N.D.	N.D.	
	1200	100%	100%	90%	73%	60%	N.D.	N.D.	N.D.	
	1100	100%	97%	78%	62%	50%	N.D.	N.D.	N.D.	
	1000	100%	83%	65%	51%	N.D.	N.D.	N.D.	N.D.	
		600	700	800	900	1000	1100	1200	1300	1400

H

L

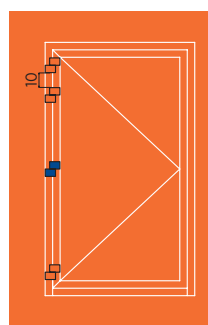
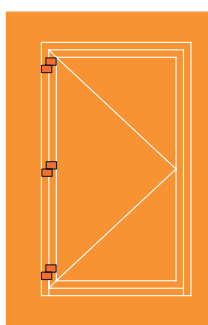
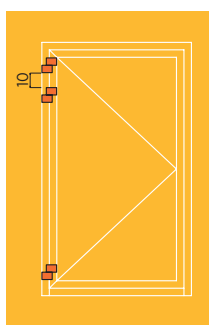
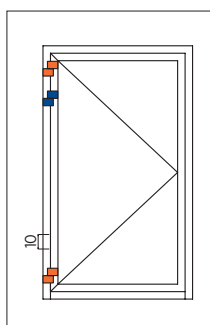

ART.		PORTATA LOAD CAPACITY
3420.71 3420.72 3421.72		100% = 80 Kg
3420.71 3420.72 3421.72	+	100% = 120 Kg

VASISTAS PESANTE HEAVY BOTTOM HINGE WINDOW

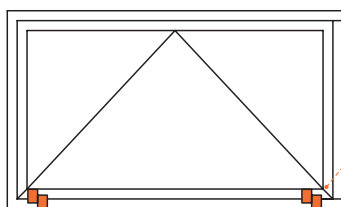

Art. 352X.33
Kit sostegno anta
Shutter support kit

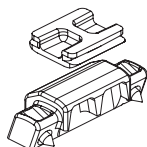

	3000	72%	80%	80%	80%	100%
	2000	72%	80%	80%	80%	100%
	1600	60%	80%	80%	80%	100%
	1100	60%	80%	80%	80%	100%
	500	48%	48%	60%	60%	74%
		500	1100	1600	2000	2500

H

L

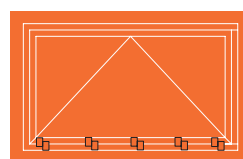
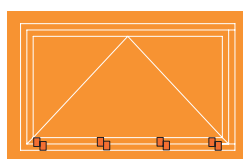
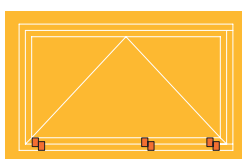
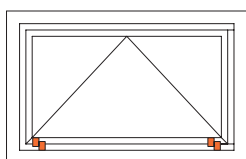

ART.	*	PORTATA LOAD CAPACITY
3420.71 3420.72	+	100% = 250 Kg
3421.72	+	100% = 140 Kg

* OBBLIGATORIO
MANDATORY



SPORGERE PROJECTING OPENING

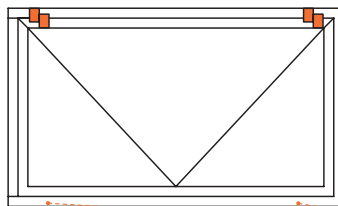

Art. 352X.33
Kit sostegno anta
Shutter support kit

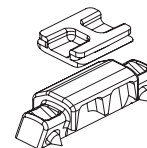

H	2000	100%	100%	100%	100%	100%	100%	100%	100%	100%	100%	100%	100%	100%	100%	100%	100%	100%	100%
	1900	100%	100%	100%	100%	100%	100%	100%	100%	100%	100%	100%	100%	100%	100%	100%	100%	100%	100%
	1800	100%	100%	100%	100%	100%	100%	100%	100%	100%	100%	100%	100%	100%	100%	100%	100%	100%	100%
	1700	100%	100%	100%	100%	100%	100%	100%	100%	100%	100%	100%	100%	100%	100%	100%	100%	100%	100%
	1600	100%	100%	100%	100%	100%	100%	100%	100%	100%	100%	100%	100%	100%	100%	100%	100%	100%	100%
	1500	100%	100%	100%	100%	100%	100%	100%	100%	100%	100%	100%	100%	100%	100%	100%	100%	100%	100%
	1400	100%	100%	100%	100%	100%	100%	100%	100%	100%	100%	100%	100%	100%	100%	100%	100%	100%	100%
	1300	100%	100%	100%	100%	100%	100%	100%	100%	100%	100%	100%	100%	100%	100%	100%	100%	100%	100%
	1200	100%	100%	100%	100%	100%	100%	100%	100%	100%	100%	100%	100%	100%	100%	100%	100%	100%	100%
	1100	100%	100%	100%	100%	100%	100%	100%	100%	100%	100%	100%	100%	100%	100%	100%	100%	100%	100%
	1000	100%	100%	100%	100%	100%	100%	100%	100%	100%	100%	100%	100%	100%	100%	100%	100%	100%	100%
	900	100%	100%	100%	100%	100%	100%	100%	100%	100%	100%	100%	100%	100%	100%	100%	100%	100%	100%
	800	100%	100%	100%	100%	100%	100%	100%	100%	100%	100%	100%	100%	100%	100%	100%	N.D.	N.D.	N.D.
	700	100%	100%	100%	100%	100%	100%	100%	100%	100%	100%	100%	100%	100%	N.D.	N.D.	N.D.	N.D.	N.D.
	600	100%	100%	100%	100%	100%	100%	100%	100%	100%	100%	N.D.	N.D.	N.D.	N.D.	N.D.	N.D.	N.D.	N.D.
	500	100%	100%	100%	100%	100%	100%	100%	100%	N.D.	N.D.	N.D.	N.D.	N.D.	N.D.	N.D.	N.D.	N.D.	N.D.
	400	100%	100%	100%	100%	100%	N.D.	N.D.	N.D.	N.D.	N.D.	N.D.	N.D.	N.D.	N.D.	N.D.	N.D.	N.D.	N.D.
	300	100%	100%	100%	100%	N.D.	N.D.	N.D.	N.D.	N.D.	N.D.	N.D.	N.D.	N.D.	N.D.	N.D.	N.D.	N.D.	N.D.
			300	400	500	600	700	800	900	1000	1100	1200	1300	1400	1500	1600	1700	1800	1900

L

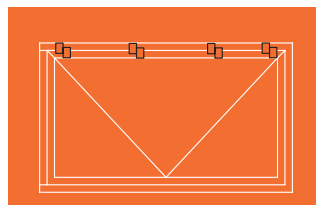
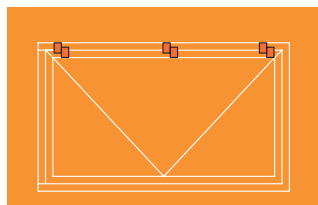
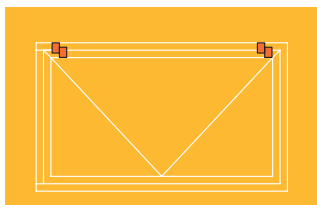

ART.	*	PORTATA LOAD CAPACITY
3420.71 3420.72	+	100% = 120 Kg
3421.72	+	100% = 110 Kg

* OBBLIGATORIO
MANDATORY