

Lucky-5 è disponibile in versione kit: il set è composto di un faretto "master" con interruttore touch e due "slave" collegati tramite distributore.

LUCKY 5

Faretto in appoggio

Lucky-5 è un faretto per sottopensili a base rettangolare, caratterizzato da uno spessore ridotto (6,5 mm) che ne consente la massima versatilità di applicazione. La versione con interruttore integrato consente l'accensione della singola lampada o dell'intera fila se collegata tramite l'apposito distributore. La sorgente LED è disponibile con temperatura di colore Naturale (4000K).

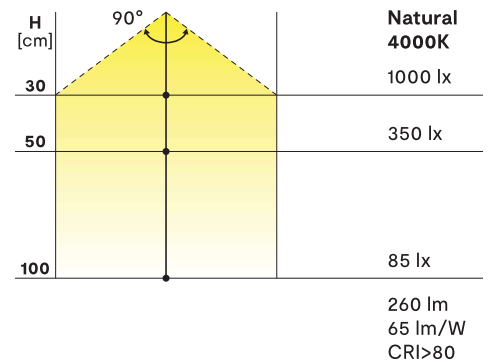

LUCKY 5

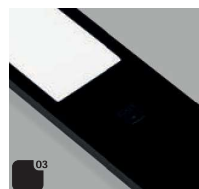
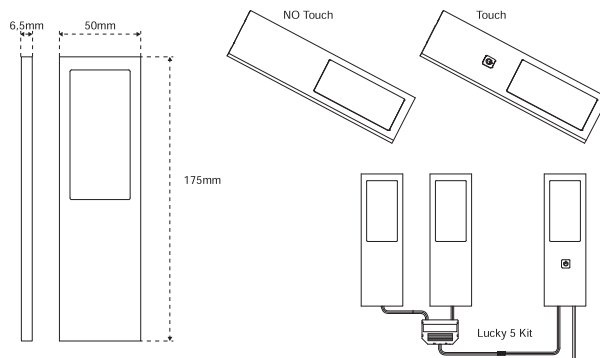



Nero



Acciaio spazzolato



LUCKY 5 12 V DC

	27900080300ZN	4 W	175 x 50 mm	4000K
	27900089100ZN			

Accessori e controllo



SMART SYSTEM

Per la scelta del sistema di controllo andare a pag. 108



MEC DRIVER

Per la scelta del sistema di controllo andare a pag. 100

LUCKY 5 TOUCH 12 V DC

	27900090300ZN	4 W	175 x 50 mm	4000K
	27900099100ZN			

Accessori e controllo



TOUCH SENSOR

Interruttore integrato per l'accensione e spegnimento della lampada.



MEC DRIVER

Per la scelta del sistema di controllo andare a pag. 100

LUCKY 5 KIT 3 SPOTS + POWER SUPPLY

	12421730300ZN	12 W		4000K
	12421739100ZN			

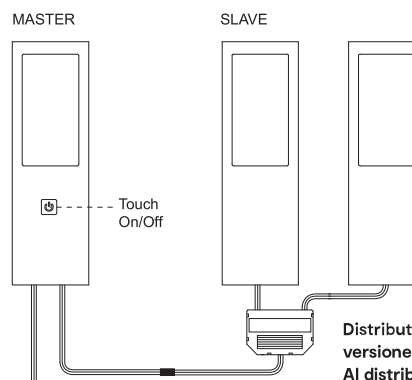

Distributore incluso nella versione con interruttore. Al distributore possono essere collegate un massimo di 6 lampade.