

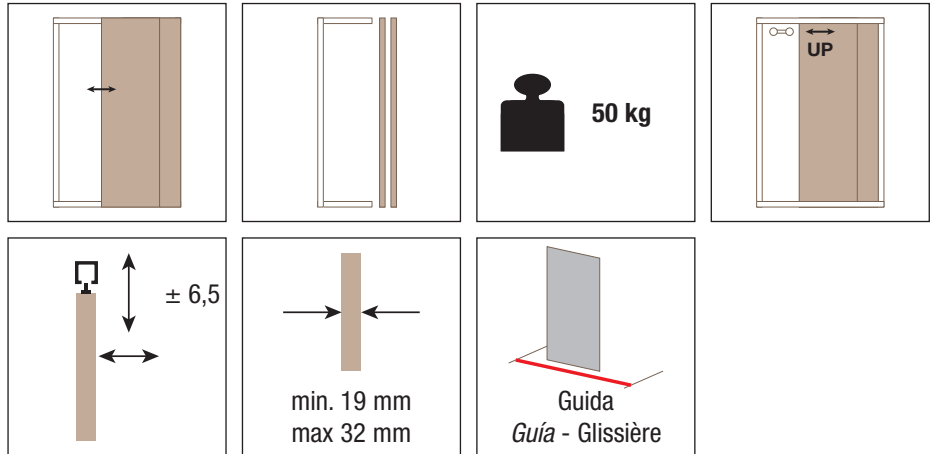

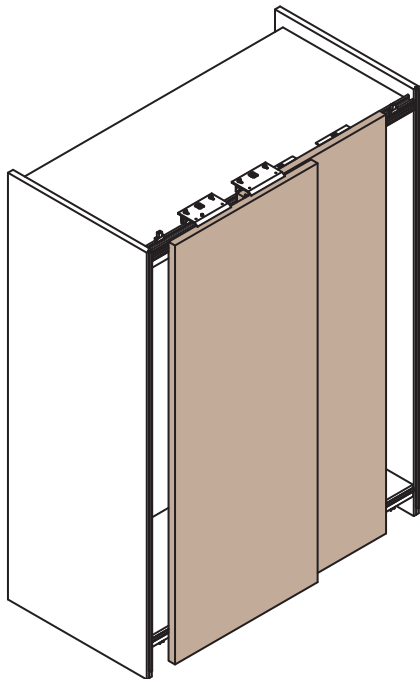

# SYSTEM 0920/50







Sistema per ante di armadi  
 Sistemas para hojas de armarios  
 Système coulissants pour portes d'armoires



<b>KIT Art. 0920/5</b>	
Anta interna <i>Hoja interna</i> Vantail intérieur	
Carrello superiore interno <i>Carro de deslizamiento superior interior</i> Patin de coulissement supérieur interne	 1+1 pcs
Pattino interno inf. <i>Patin inferior interior</i> Patin de coulissement inférieur interne	 1+1 pcs

<b>KIT Art. 0920/6</b>	
Anta esterna <i>Hoja externa</i> Vantail extérieur	
Carrello superiore esterno <i>Carro de deslizamiento superior exterior</i> Patin de coulissement supérieur externe	 1+1 pcs
Pattino esterno inf. <i>Patin inferior exterior</i> Patin de coulissement inférieur externe	 1+1 pcs

<b>*Ricambi - *Repuestos - *Echanges</b>	
<b>Art. 0920/53(DX)</b> <b>Art. 0920/54(SX)</b> Carrello superiore interno <i>Carro de deslizamiento superior interior</i> Patin de coulissement supérieur interne	 1 pcs
<b>Art. 0920/57(DX)</b> <b>Art. 0920/58(SX)</b> Carrello superiore esterno <i>Carro de deslizamiento superior exterior</i> Patin de coulissement supérieur externe	 1 pcs
<b>Art. 0920/51(DX)</b> <b>Art. 0920/52(SX)</b> Pattino interno inf. <i>Patin inferior interior</i> Patin de coulissement inférieur interne	 1 pcs
<b>Art. 0920/55(DX)</b> <b>Art. 0920/56(SX)</b> Pattino esterno inf. <i>Patin inferior exterior</i> Patin de coulissement inférieur externe	 1 pcs

<b>Accessori compatibili Accesorios compatibles Accessoires compatibles</b>	
<b>Art. 0910/1</b> <b>Art. 0910/10</b> Binario sup. in alluminio anodizzato e forato <i>Guía superior soporte cepillo aluminio anodizado y perforado</i> Rail supérieur en aluminium anodisé et perforé	m 6 m 3 
<b>Art. 0920/1</b> <b>Art. 0920/2</b> Binario inf. allum. anodizzato e forato <i>Guía en aluminio anodizada y perforada</i> Rail inf. en aluminium anodisé et perforé	m 6 m 3 
<b>Art. 0910/8</b> Parapolvere superiore <i>Parapolvo superior</i> Cache poussière supérieur	m 1 
<b>Art. 0910/7</b> Spazzolino parapolvere <i>Cepillo antipolvo</i> Balais anti-poussière	m 3 
<b>Art. 0910/5</b> Fermo d'arresto superiore <i>Freno superior</i> Butée d'arrêt supérieure	
<b>Art. 0920/7</b> Battuta inferiore d'arresto <i>Tope inferior</i> Butée d'arrêt inférieure	

\*Gli articoli presenti nella tabella "Ricambi" sono ordinabili **solo** nelle quantità indicate.  
 \*Los artículos presentes en la tabla "Repuestos" se pueden pedir **sólo** en las cantidades indicadas.  
 \*Les accessoires présents dans le tableau "pièces de rechanges" sont vendus **seulement** dans les quantités indiquées.

**Soluzioni scorrevoli realizzabili**  
**Soluciones correderas realizables**  
**Solutions réalisables avec portes coulissantes**

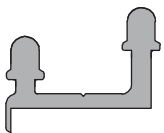
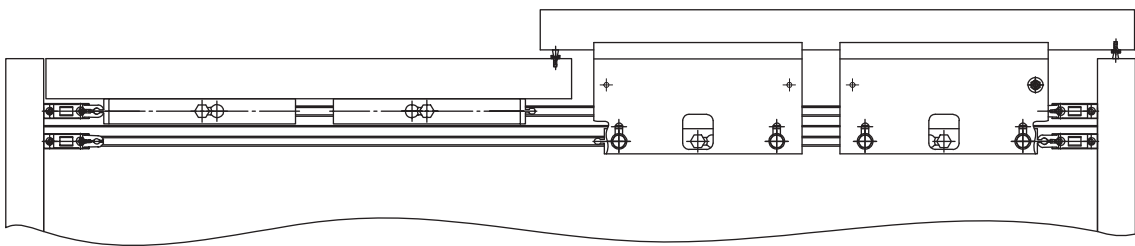
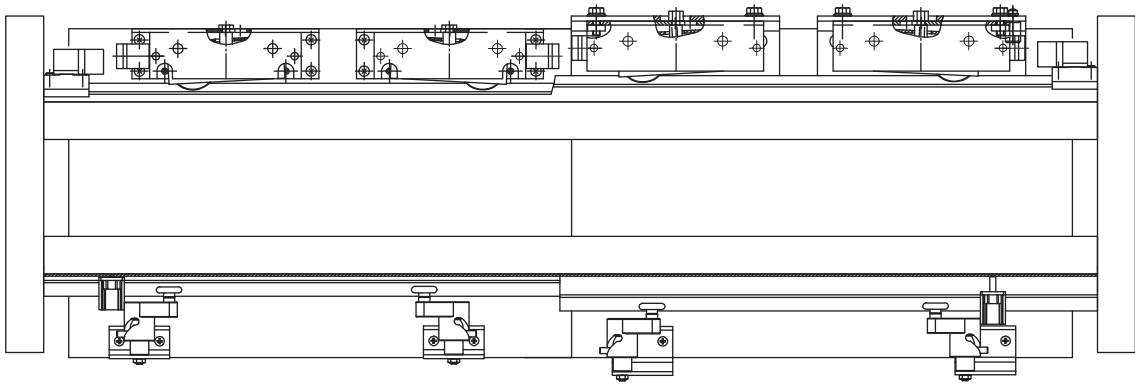
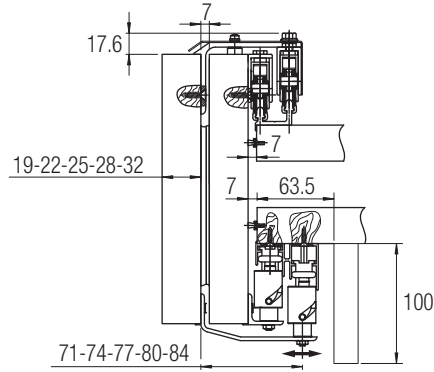
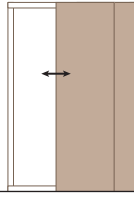

**50 kg**