

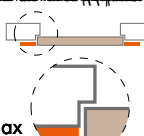

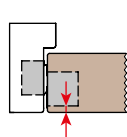
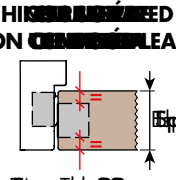
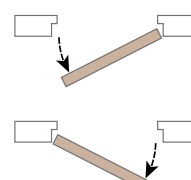
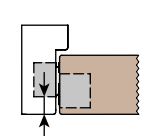
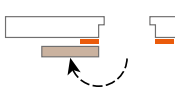
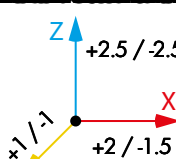

KUBICA K6360 38 HYBRID

PATENTED

<p>MATERIALE</p> <p>Casing: Steel Adjuster: Acero Geopis: Zamak Cierre: Zamak</p>	<p>LOAD CAPACITY 60 kg (12 Dinges)</p> 	<p>APPLICAZIONE Effetto di rotazione (90°/180°)</p>  <p>max 12 mm</p>	<p>MECCANICA</p>  <p>K-max 4 mm</p>
<p>HIGHER ADJUSTED ON OPENING LEAF</p>  <p>Esp. max 38 mm</p>		 <p>max 12 mm</p>	<p>OPENING ANGLE D'APERTURE 180°</p> 
<p>PRECISION POSITIONING</p>  <p>Z +2.5 / -2.5 X +2 / -1.5 Y +1 / -1</p>	<p>PERFORMING Full HD</p> 	<p>NUMBER OF POINTS 5</p> 	<p>NUMBER OF POINTS 5</p> 
<p>Test report</p> <p>ift ROSENHEIM</p> <p>UNI EN1191:2012 Windows and doors Resistance to opening and closing</p> <p>Internal door with hinges mod. K6360 38/45 Total door weight: 60kg</p>		<p>MADE IN ITALY</p> 	

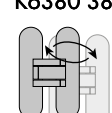

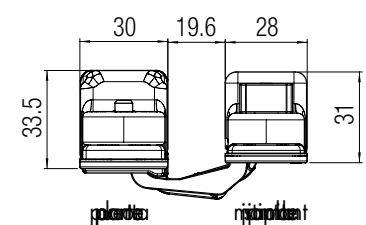
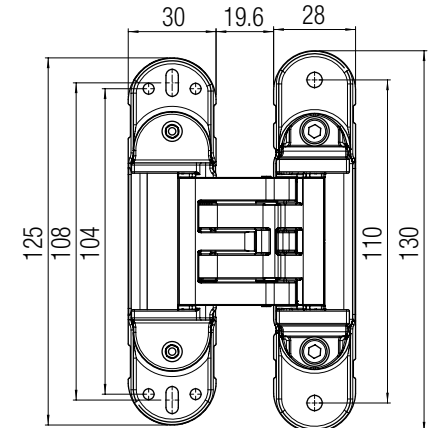
Acabados

Color	Código de Art.
Chromado	K 6360 38 CL
Estimado	K 6360 38 CS
Níquel satinado	K 6360 38 NS
Chromado	K 6360 38 OL
Bronze	K 6360 38 BR
Chromado	K 6360 38 OTL
Blanco	K 6360 38 BI
Negro	K 6360 38 NR

Per informazioni sui punti di vendita Krona Koblentz, visitate il sito Krona Koblentz o contattate il nostro servizio clienti al numero 0934 400000.



Toball d'aplicacions (després de llegir la guia de lectura)

JEM

K6360 38 - 60 Kg - N°22											
2000	60	60	60	60	60	60	60	60	60	58	56
1950	60	60	60	60	60	60	60	60	60	59	56
1900	60	60	60	60	60	60	60	60	60	57	55
1850	60	60	60	60	60	60	60	60	60	58	56
1800	60	60	60	60	60	60	59	56	54	52	50
1750	60	60	60	60	60	60	57	55	53	51	49
1700	60	60	60	60	60	58	56	53	51	49	47
1650	60	60	60	60	60	57	54	52	50	48	46
1600	60	60	60	60	58	55	52	50	48	46	44
1550	60	60	60	59	56	53	51	49	47	45	43
1500	60	60	60	57	54	52	49	47	45	43	42
1450	60	60	58	55	52	50	48	45	44	42	40
1540	60										
	926	700	800	900	950	1000	1050	1100	1150	1200	1300

- Testat amb pes de 60 kg a 2200 mm de altura amb un angle de 90°.
 ** Veure dimensions de composició en el diagrama de detall de la guia de lectura. **La responsabilitat de la correcta aplicació i el correcte ús de la guia de lectura és del client.**

Quantitat d'aplicacions per porta

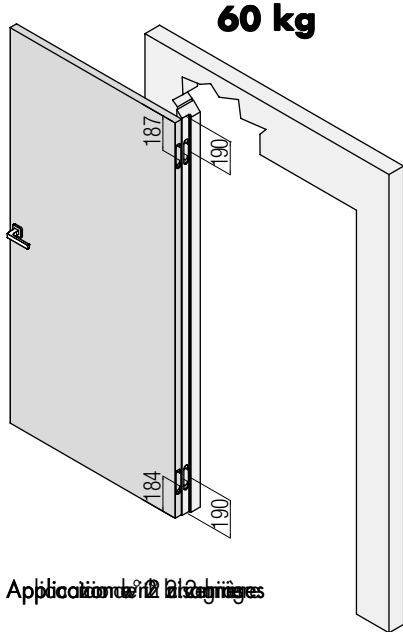

Aplicacions per porta

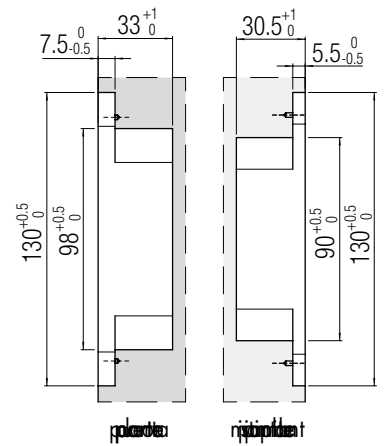

Installation of the handle on the door leaf

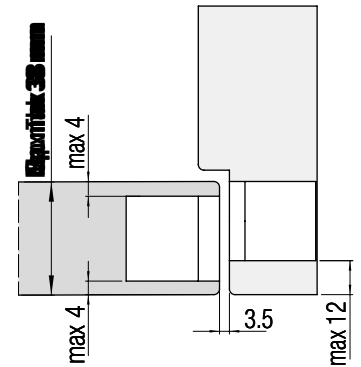

Installation of the handle on the door leaf

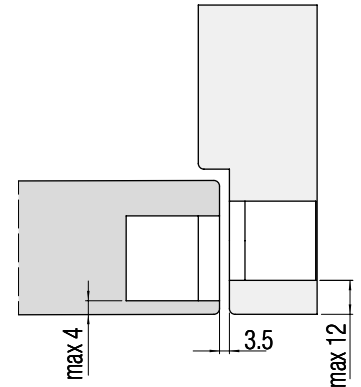

Verificar la correcta aplicació i el correcte ús de la guia de lectura.

