



**Ferexpert** S.p.A.



**CONFAIÖNIERI**

## LIB0132

Design:  
Fabio Casiraghi\_Studio Nava

Materiale  
Ottone

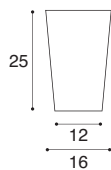

Oro lucido	51150150
------------	----------

## LIB0134

Design:  
Noemi Carbonari\_Studio Nava

Materiale  
Ottone

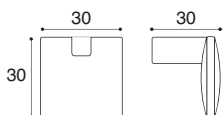

Cromo lucido	51150200
--------------	----------

Nichel "D"	51150210
------------	----------

Oro lucido	51150220
------------	----------

## LIB0143

Design:  
Luca Casini

Materiale  
Ottone

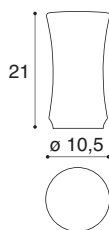

Cromo lucido	51152300
--------------	----------

Nichel "D"	51152310
------------	----------

## LIF0133

Design:  
Fabio Casiraghi\_Studio Nava

Materiale  
Ottone

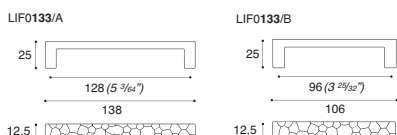

Oro lucido	Su ordinazione	Su ordinazione
------------	----------------	----------------

## LIF0135

Design:  
Noemi Carbonari\_Studio Nava

Materiale  
Ottone

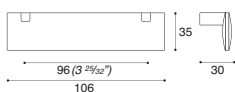

Nichel "D" Velour	50702096
-------------------	----------

Oro lucido	50702196
------------	----------



# LIB0024

Materiale  
Ottone

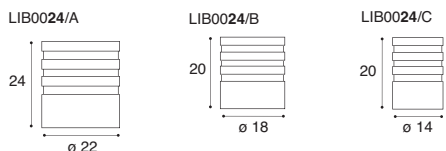

Cromo lucido	51153000	51153100	51153200
Nichel "D"	51153010	51153110	51153210



# LIB0081

Design:  
Emme Design

Materiale  
Ottone

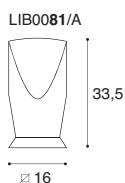

Nichel "D"	51155000
Oro lucido	51155010



# LIB0098

Design:  
Emme Design

Materiale  
Ottone

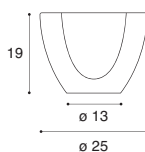

Nichel	51732625
Oro lucido	51732125



# LIB0119

Design:  
Noemi Carbonari\_Studio Nava

Materiale  
Ottone

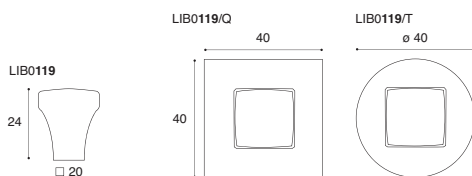

Nichel "D"	51149320	51150010	51150050
Cromo lucido	Su ordinazione	51150000	Su ordinazione
Oro lucido	Su ordinazione	51150020	Su ordinazione



# LIB0123

Design:  
Fabio Casiraghi\_Studio Nava

Materiale  
Ottone

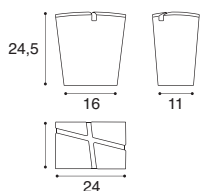

Oro lucido	51150100
------------	----------



## MB00108

Design:  
S.&.R.C

Materiale  
Polipropilene

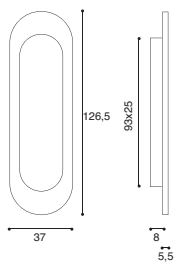

Nero

Su ordinazione



## MB00770

Design:  
S.&.R.C

Materiale  
Nylon

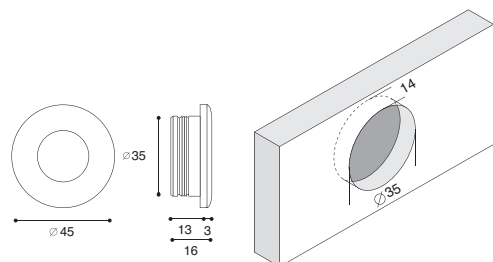

Bianco

50206035

Nero

50206135



## MB00848

Design:  
Franco Guanzioli

Materiale  
Bussola in ottone  
Polimero morbido

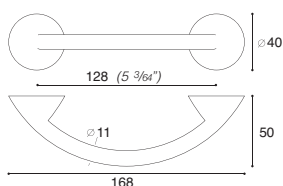

Nero

50600128



## MB00853

Design:  
S. & R. C.

Materiale  
Metallo presso fuso  
Scatola in nylon

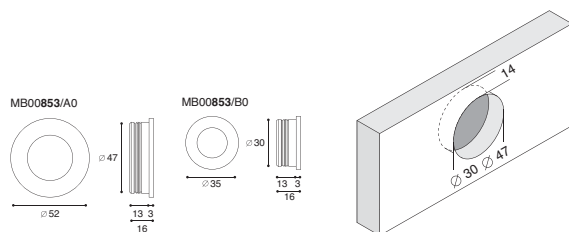

Cromo lucido

50206448

50206431

Nichel satinato opaco

50206447

50206430

Oro lucido

Su ordinazione

50206432



## MB00863

Design:  
S. & R. C.

Materiale  
Metallo presso fuso

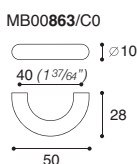

Bianco

Su ordinazione

Nero

Su ordinazione

Cromo lucido

Su ordinazione

Nichel satinato

Su ordinazione

Oro lucido

Su ordinazione



## MB00864

Design:  
S. & R. C.

Materiale  
Ottone

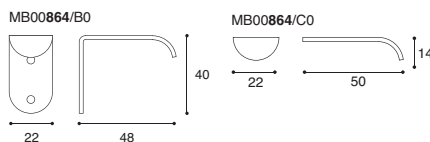

Argento 7	50715040	50710120
Cromo lucido	50715240	50710240
Cromo satinato	50715840	50710140
Oro lucido	50715140	50710040

## MB00866

Design:  
S. & R. C.

Materiale  
Metallo pressato fuso

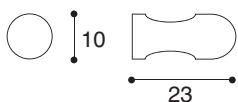

Bianco	51530010
Nero	51530020
Cromo lucido	51530040
Nichel satinato opaco	51529810
Nichel satinato	51530050
Oro lucido	51530060

## MB00869

Design:  
S. & R. C.

Materiale  
Metallo pressato fuso  
Impugnatura: polimero morbido

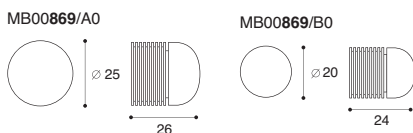

Nero	51721225	51721220
------	----------	----------

## MB00871

Materiale Ottone o Acciaio

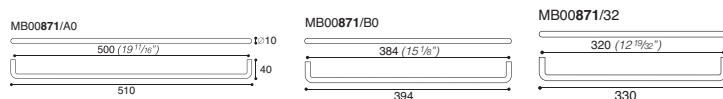

Cromo lucido	50730550	50730538	50730532
Nichel satinato	50730650	50730638	50730632
Oro lucido	50730150	50730138	Su ordinazione

Cromo lucido	50730522	50730516	
Nichel satinato	50730622	50730616	
Oro lucido	50730122	50730116	
Scarpette plastica			50731000

## MB00884

Design:  
Castiglia Associati

Materiale  
Metallo pressato fuso

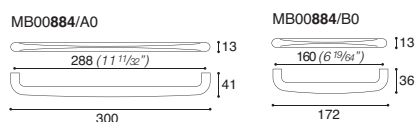

Cromo lucido	50722528	50722516
Nichel satinato	50722628	50722616



## MB00897

Design:  
Carlo Bartoli

Materiale  
Ottone

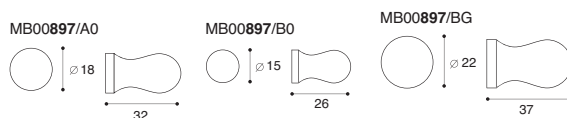

Argento 7	51551030	51551530	Su ordinazione
Cromo lucido	51551010	51551510	Su ordinazione
Cromo satinato	51551020	51551520	51551004

## MB00898

Design:  
Carlo Bartoli

Materiale  
Ottone

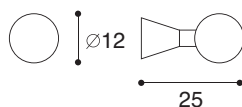

Argento 7	51705212	Nero	51706212
Bianco	51706112	Oro lucido	51705112
Cromo lucido	51705412		
Cromo satinato	51705812		

## MB00907

Design:  
Giorgio Raimondi

Materiale  
Metallo presso fuso

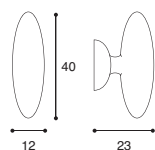

Argento 7	51707312
Cromo lucido	51707012
Cromo satinato	51707112
Dorato	81707212

## MB00908

Design:  
Giorgio Raimondi

Materiale  
Metallo presso fuso

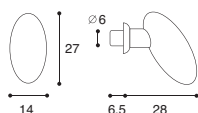

Cromo lucido	51707514
Cromo satinato	51707614

## MB00912

Design:  
S. & R. C.

Materiale  
Base: ottone  
Impugnatura: cuoio

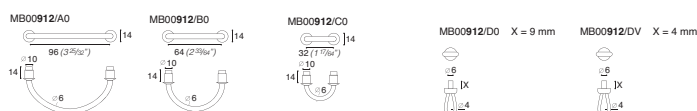

Argento 7	50733096	50733064	50733032	50733000	Su ordinazione
Nichel satinato	50733196	50733164	50733132	50733100	Su ordinazione



## MB00885

Design:  
S. & R. C.

Materiale  
Ottone

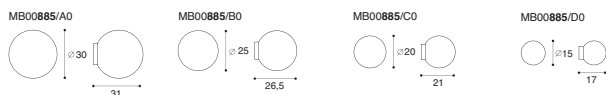

Bianco	51531040	51531140	Su ordinazione	51531340
Cromo lucido	51531010	51531110	51531210	51531240
Cromo satinato	51531020	51531120	51531220	51531320
Oro lucido	51531030	51531130	51531230	51531330

## MB00886

Design:  
Roberto Lazzaroni

Materiale  
Metallo presso fuso

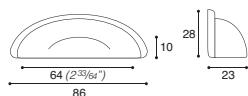

Cromo lucido	50723020
Dorato	50723030
Nichel satinato	50723040

## MB00890

Design:  
Mauro Carlesi

Materiale  
Metallo presso fuso

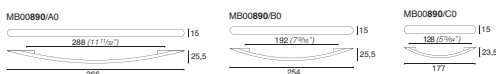

Argento 7	50732708	50732706	50732704
Cromo lucido	50732828	50732819	50732812
Dorato	50732928	50732919	50732912
Nichel satinato	50732728	50732719	50732712

## MB00892

Design:  
S. & R. C.

Materiale  
Metallo presso fuso

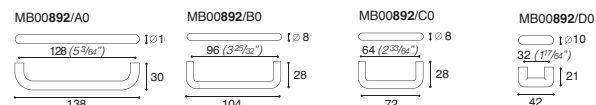

Argento 7	50724128	50724096	50724064	50724032
Bianco	50725212	50725196	50725164	50725132
Cromo lucido	50724612	50724596	50724564	50724232
Nero	50725312	50725296	50725264	50725232
Nichel satinato	50724812	50724796	50724764	50724732
Oro lucido	50724212	50724196	50724164	50724132

## MB00894

Design:  
Mauro Carlesi

Materiale  
Metallo presso fuso

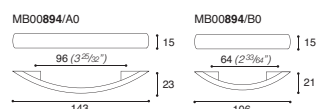

Argento 7	50726396	50726364
Cromo lucido	50726096	50726064
Dorato	50726196	50726164
Nichel satinato	50726296	50726264



## MB00939

Design:  
Paolo Nava

Materiale  
Ottone

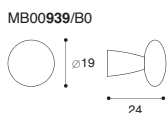

Cromo lucido	51715419
Nichel satinato	51715819
Oro lucido	51715119

## MB00945

Design:  
Paolo Nava

Materiale  
Metallo presso fuso

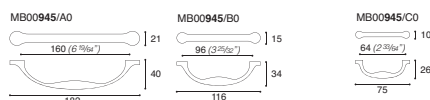

Bronzo	50734016	Su ordinazione	Su ordinazione
Cromo lucido	50734116	50734196	50734164
Dorato	Su ordinazione	Su ordinazione	Su ordinazione
Nichel satinato	50734316	50734396	50734364

## MB00946

Design:  
Paolo Nava

Materiale  
Metallo presso fuso

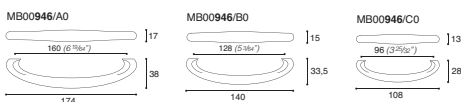

Cromo lucido	50734412	50734416	50734418
Nichel satinato	50734516	50734512	50734596

## MB00948

Design:  
Paolo Nava

Materiale  
Ottone

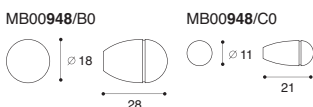

Cromo lucido	51710418	Su ordinazione
Nichel satinato	51710818	51710011
Oro lucido	51710118	Su ordinazione

## MB00960

Materiale  
Metallo presso fuso

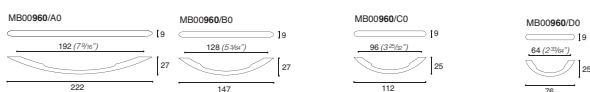

Argento 7	50727092	50727090	50727088	50728086
Bianco	50728219	50728212	50728196	50728164
Cromo lucido	50727519	50727512	50727496	50727464
Dorata	50727219	50727212	50727196	50727264
Nero	50728419	50728412	50728396	50728364
Nichel satinato	50727719	50727712	50727696	50727764
Oro satinato	50727319	50727312	50727296	Su ordinazione





## MB00919

Design:  
Carlo Bartoli

Materiale  
Metallo pressato fuso

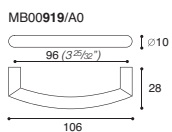

Nichel satinato	50733796
-----------------	----------

## MB00930

Design:  
Carlo Bartoli

Materiale  
Metallo pressato fuso

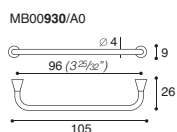

Cromo lucido	50740596
Oro lucido	50740196

## MB00931

Design:  
Carlo Bartoli

Materiale  
Metallo pressato fuso

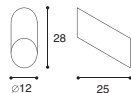

Cromo lucido	51707700
Nichel satinato	51707710

## MB00932

Design:  
Franco Guanzioli

Materiale  
Box: Metallo pressato fuso  
Impugnatura: Cuoio naturale

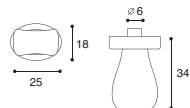

Argento 7	51707830
Cromo lucido	51707800
Nichel satinato	51707810

## MB00934

Design:  
S. & R. C.

Materiale  
Ottone

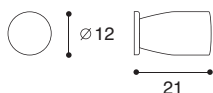

Argento 7	51712012
Cromo lucido	51712212
Cromo satinato	51712112



## MB09010

Design:  
Giuseppe Viganò

Materiale  
Supporti: metallo presso fuso  
Impugnatura: polipropilene,  
policarbonato

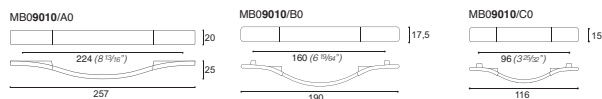

Trasp. supporto cromo lucido	50745260	50745255	50745250
------------------------------	----------	----------	----------

## MB09012

Design:  
Paolo Nava

Materiale  
Supporti: metallo presso fuso  
Impugnatura: acciaio

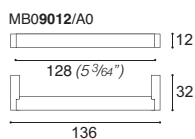

Argento 7	50796912
-----------	----------

## MB09016

Design:  
S.&.R.C.

Materiale  
Metallo presso fuso

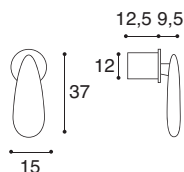

Argento 7	51725530
Cromo lucido	51725500
Dorato	51725510
Nichel satinato	51725520

## MB09017

Design:  
S. & R. C.

Materiale  
Alluminio

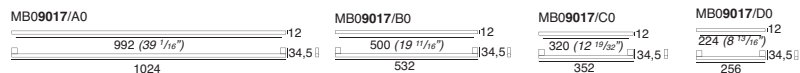

Argento	50745499	50745450	50745432	50745422
Nichel satinato	50745699	Su ordinazione	50745632	Su ordinazione

## MB09020

Materiale  
Metallo presso fuso

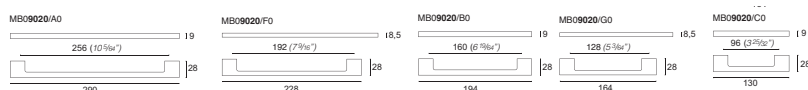

Argento 7	50746025	50746016	50746096	50746030	50746012
Cromo lucido	50745825	50745816	50745896	50745830	50745812
Nichel "D"	50746125	50746116	50746196	Su ordinazione	50746112
Nichel satinato	50745925	50745916	50745996	50745930	50745912



## MB00976

Design:  
Paolo Nava

Materiale  
Metallo presso fuso

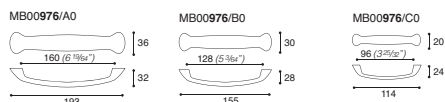

Argento 7	50735160	50735128	50735096
Nichel satinato	50734616	50764612	50734696

## MB00997

Design:  
Paolo Nava

Materiale  
Metallo presso fuso

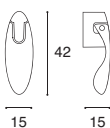

Cromo lucido	51724715
Dorato	51724815
Nichel satinato	51724615

## MB09004

Design:  
S. & R. C.

Materiale  
Acciaio inox

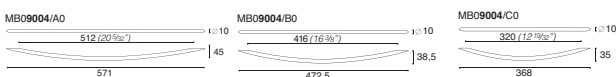

Inox lucido	50745151	50745141	50745132
Inox satinato	50745051	50745041	50745032



Inox lucido	50745122	50745116
Inox satinato	50745022	50745016

## MB09006

Design:  
Paolo Nava

Materiale  
Base: metallo presso fuso  
Impugnatura: cuoio

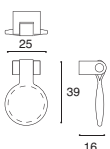

Cromo lucido	51725000
Nichel Velour	51755010

## MB09008

Design:  
Mauro Carlesi

Materiale  
Metallo presso fuso

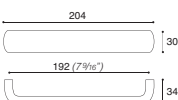

Argento 7	50745192
Nichel satinato	50745219





## MB09052

Design:  
Mauro Carlesi

Materiale  
Metallo presso fuso

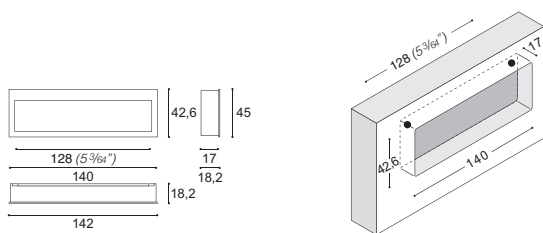

Argento 7 50207700



## MB09056

Design:  
Giuseppe Viganò

Materiale  
Metallo presso fuso



Cromo lucido 50792392 50792328 50792300



## MB09064

Design:  
Paolo Nava

Materiale  
Alluminio



Argento 7 50795528 50795522



## MB09066

Design:  
S. & R. C.

Materiale  
Alluminio, Acciaio inox

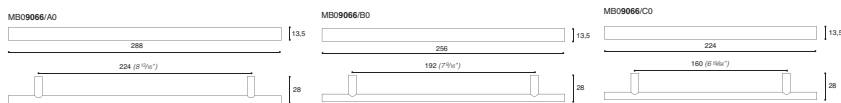

Argento 7 50796122 50796119 50796116

Inox satinato 50796022 50796019 50796016



Argento 7 50796112 50796001

Inox satinato 50796012 50796000



## MB09073

Design:  
Paolo Nava

Materiale  
Alluminio, Acciaio inox, Ottone

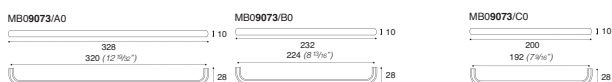

Argento 7 50796330 50796325 50796320



Argento 7 50796315 50796310



## MB09021

Design:  
Bartoli Design

Materiale  
Metallo presso fuso

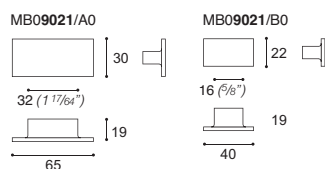

Argento 7	50794932	50794916
Cromo lucido	50795032	50795016
Nichel satinato	50795132	50795116

## MB09031

Design:  
S.&.R.C

Materiale  
Base: metallo presso fuso  
Impugnatura: cuoio

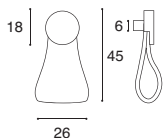

Cromo lucido	51726000
Nichel "D"	51726010

## MB09044

Design:  
Franco Guanzioli

Materiale  
Polimero morbido

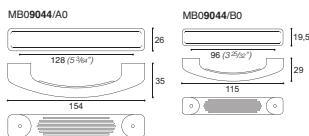

Grigio	50793128	50793096
--------	----------	----------

## MB09045

Design:  
Franco Guanzioli

Materiale  
Metallo presso fuso

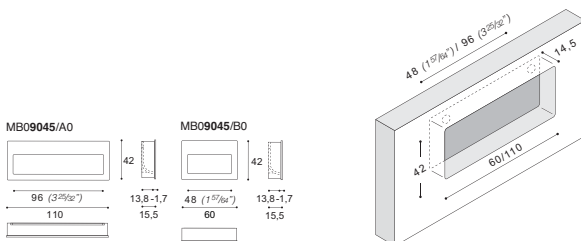

Argento 7	50207011	50207060
Cromo lucido	50207111	50207160
Nichel satinato	50207211	50207260

## MB09046

Design:  
Paolo Nava

Materiale  
Metallo presso fuso  
Impugnatura: acciaio

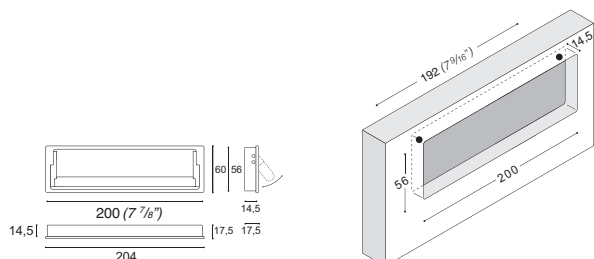

Argento 7	50207500
-----------	----------



## MB09096

Design:  
Paolo Nava

Materiale  
Acciaio inox  
Inserti in metallo pressofuso

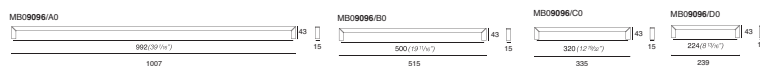

Inox lucido	50798199	50798150	50798132	50798122
Argento 7	50798320	50798310	50798300	Su ordinazione
Inox satinato	50798099	50798050	50798032	50798022

## MB09099

Design:  
Massimo Cavana

Materiale  
Metallo presso fuso

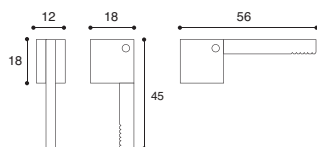

Argento 7	51726490
Cromo lucido	51726500

## MB09101

Design:  
Luca Casini

Materiale  
Metallo presso fuso

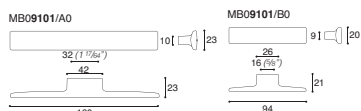

Argento 7	50788525	50788514
Cromo lucido	50788520	50788516

## MB09102

Design:  
Massimo Cavana

Materiale  
Metallo presso fuso

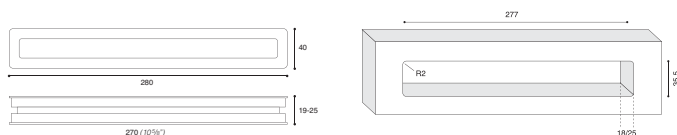

Argento 7	50223000
Cromo lucido	50223010

## MB09106

Design:  
Luca Casini

Materiale  
Metallo presso fuso

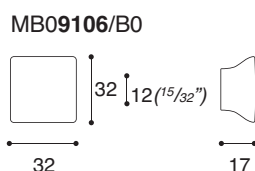

Argento 7	50799012
Nichel satinato	50799050



## MB09078

Design:  
Massimo Cavana

Materiale  
Acciaio, Metallo presso fuso

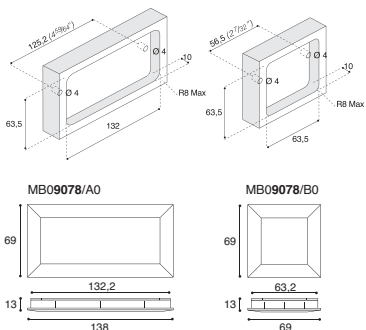

Argento 7	50220015	50220020
Nichel satinato	50220000	50220010

## MB09080

Design:  
S.&.R.C.

Materiale  
Alluminio

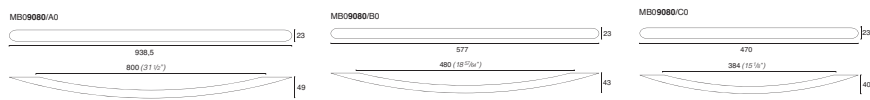

Argento 7	50797080	50797148	50797138
-----------	----------	----------	----------

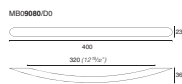

Argento 7	50797132
-----------	----------

## MB09089

Design:  
Massimo Cavana

Materiale  
Metallo presso fuso

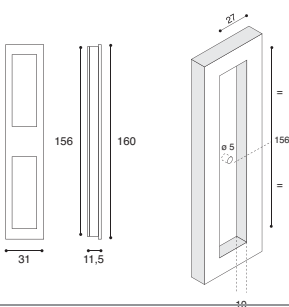

Argento 7	50222000
Nichel satinato	50222010 Su ordinazione
Cromo lucido	50222020

## MB09093

Design:  
Colombo & Vantusso

Materiale  
SAN

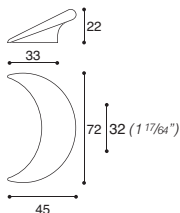

Arancione trasparente	50745300
-----------------------	----------

## MB09095

Design: Paolo Nava  
Materiale: Acciaio inox,  
Inserti in metallo pressofuso

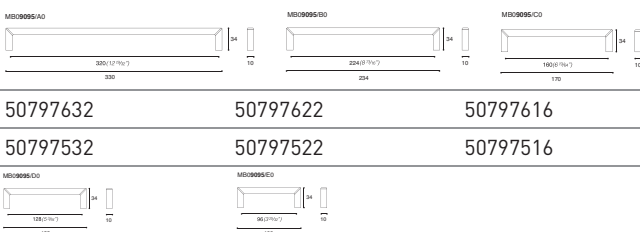

Inox lucido	50797632	50797622	50797616
Inox satinato	50797532	50797522	50797516

Inox lucido	50797612	50797696
Inox satinato	50797512	50797596





# MB09103

Design:  
Luca Casini

Materiale  
metallo pressofuso



Cromo lucido	50798400	50798360	50798350
Nichel satinato	50798380		

# MB09107

Design:  
Massimo Cavana

Materiale  
Metallo presso fuso

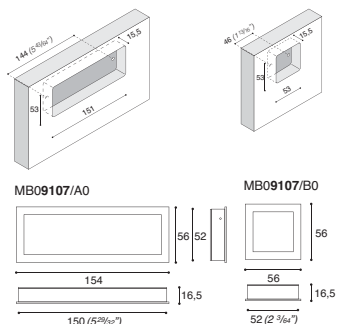

Argento7	50223540	50223550	Su ordinazione
Nichel satinato	50223500	50223510	
Cromo lucido	50223520	50223530	

# MB09110

Design:  
Luca Casini

Materiale  
Metallo presso fuso

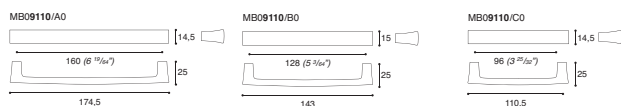

Argento 7	50798520	50798510	50798500
-----------	----------	----------	----------

# MB09111

Design:  
S. & R. C.

Materiale  
alluminio

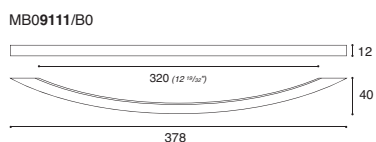

Argento 7	50745390
-----------	----------

# MB09112

Design:  
Giuseppe Viganò

Materiale  
base:  
metallo pressofuso  
impugnatura:  
alluminio

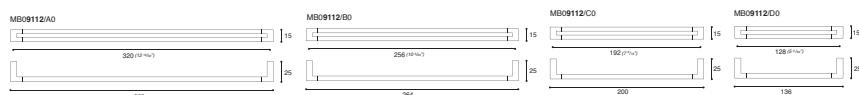

Argento 7	50798435	50798430	50798425	50798420
-----------	----------	----------	----------	----------



## MB09113

Design:  
Franco Guanzioli

Materiale  
Metallo presso fuso  
Alluminio

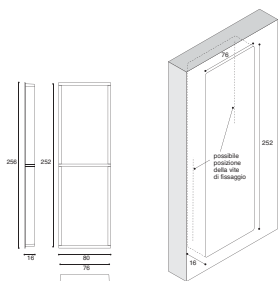

Argento 7	50224000
Cromo lucido	50224010



## MB09115

Design:  
Franco Guanzioli

Materiale  
Metallo presso fuso

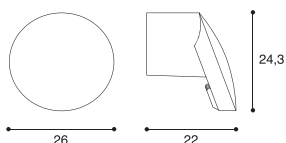

Argento 7	51527100
-----------	----------



## MB09116

Design:  
Cairolì & Donzelli

Materiale  
Metallo presso fuso  
Molla in acciaio

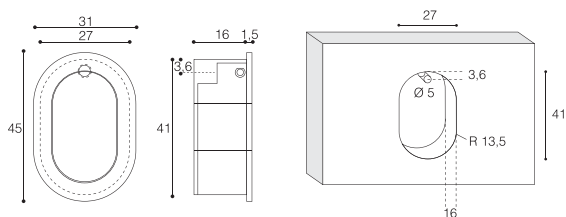

Argento 7	50225000	Su ordinazione
Cromo lucido	50225010	Su ordinazione
Nichel satinato	50225020	Su ordinazione



## MB09117

Design:  
Colombo & Vantusso

Materiale  
SAN, ABS

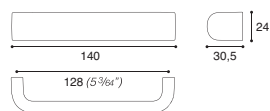

Trasparente	50745328
-------------	----------



## MB09120

Design:  
Luca Casini

Materiale  
Metallo presso fuso



Argento 7	50789320	50789315	50789310
Cromo lucido	50789016	50789012	50789096
Nichel satinato	50789216	50789212	50789296



## MB09121

Design:  
Marelli & Molteni

Materiale  
Alluminio, Metallo pressato fuso

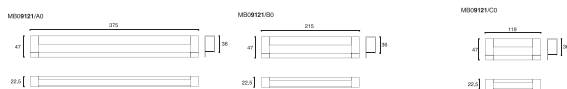

Argento 7	50227347	50227214	50227118
-----------	----------	----------	----------

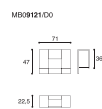

Argento 7	50227070
-----------	----------

## MB09124

Design:  
Massimo Cavana  
Materiale  
Metallo pressato fuso

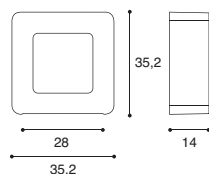

Argento 7	50789520
-----------	----------

Cromo lucido	50789500
--------------	----------

Nichel satinato	50789510
-----------------	----------

## MB09125/6/7

Design:  
Marconato & Zappa

MB09125                      MB09126                      MB09127

Materiale  
Base: ottone  
Impugnatura: resina poliesteri

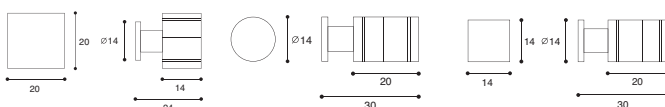

Multicolor	51727000	51727010	51727020
	Su ordinazione	Su ordinazione	Su ordinazione

## MB09131

Design:  
Marelli & Molteni

Materiale  
Metallo pressato fuso

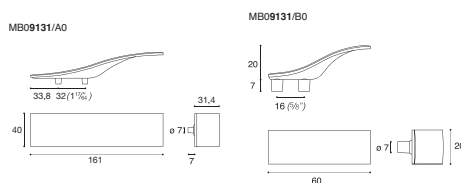

Argento 7	50799332	50799316
-----------	----------	----------

Cromo lucido	50799132	50799116
--------------	----------	----------

Bianco opaco	50799232	50799216
--------------	----------	----------

## MB09132

Design:  
Marelli & Molteni

Materiale  
Metallo pressato fuso

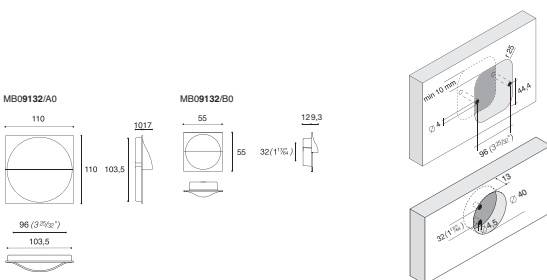

Argento 7	50227610	50227555
-----------	----------	----------

Cromo lucido	Su ordinazione	50227655
--------------	----------------	----------

Bianco opaco	Su ordinazione	50227755
--------------	----------------	----------



## MB09133

Design:  
Marelli & Molteni

Materiale  
Alluminio, Metallo pressato fuso

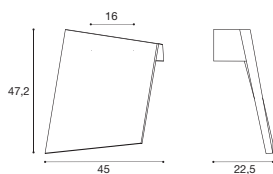

Argento 7	50799516
Cromo lucido	50799510
Nichel satinato	50799512

## MB09134

Design:  
Paolo Nava

Materiale  
Alluminio, Metallo pressato fuso

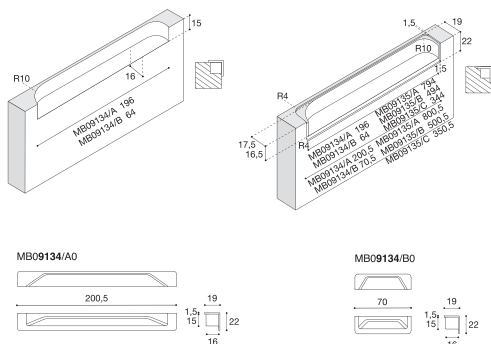

Argento 7	50228200	50228170
-----------	----------	----------

## MB09136

Design:  
Massimo Cavana

Materiale  
Metallo pressato fuso

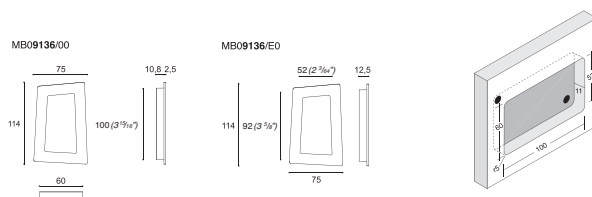

Argento 7	50228410	50228400
-----------	----------	----------

## MB09137

Design:  
Simone Micheli

Materiale  
Acciaio Inox

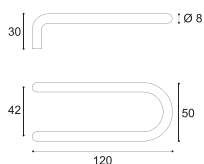

Inox satinato	50799542
---------------	----------

## MB09138

Design:  
Marelli & Molteni

Materiale  
Metallo pressato fuso

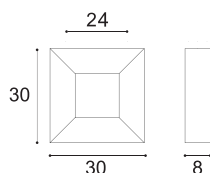

Argento 7	50799600
-----------	----------



## MB09139

Design:  
Simone Micheli

Materiale  
Metallo presso fuso

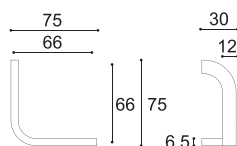

Argento 7	50799700
-----------	----------

## MB09140

Design:  
Marelli & Molteni

Materiale  
Metallo presso fuso

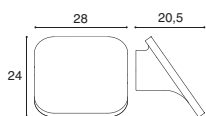

Argento 7	51725550
-----------	----------

Cromo lucido	51725555
--------------	----------

## MB09142

Design:  
Fabio Casiraghi\_Studio Nava

Materiale  
Metallo presso fuso

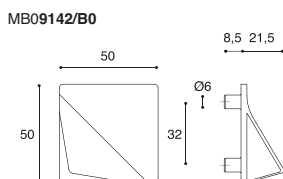

Argento 7	50799770
-----------	----------

Cromo lucido	50799750
--------------	----------

Bianco opaco	50799760
--------------	----------

## MB09144

Design:  
Fabio Casiraghi\_Studio Nava

Materiale  
Metallo presso fuso

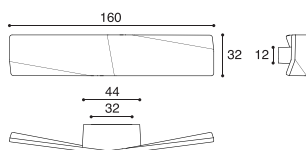

Argento 7	50799795
-----------	----------

Cromo lucido	50799800
--------------	----------

Antracite satinato	50799815
--------------------	----------

Nichel satinato	50799810
-----------------	----------

Bianco	50799805
--------	----------

## MB09145

Design:  
Fabio Casiraghi\_Studio Nava

Materiale  
Metallo presso fuso

Incasto "a filo" dell'anta o "in appoggio".  
Nella finitura bianco opaco, è possibile lac-  
care in autonomia le maniglie come l'anta del  
mobile offrendo così una maggiore integra-  
zione. Poiché il fondo della maniglia è aperto  
è possibile inserire un fondo in contrasto o  
"tono su tono" con la finitura del mobile.

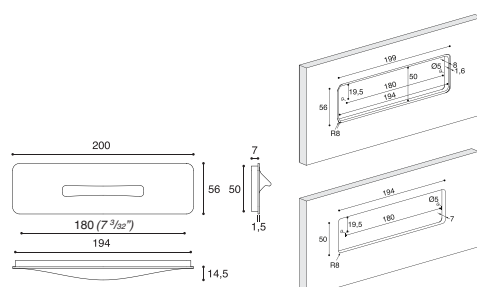

Cromo lucido	50228600
--------------	----------

Nichel satinato	50228610
-----------------	----------



# “Touch system” MB09141

Design:  
Cairolì e Donzelli

Quando premuta, TOUCH dà accesso ad una rientranza ricavata nell'anta stessa; cessata la pressione, ritorna in posizione di riposo grazie ad un sistema meccanico.

Materiale  
Barra: alluminio  
Cerniera: zama  
Molla in acciaio  
Maniglia da incasso: Polipropilene



Vista fronte, chiusa



Vista fronte, chiusa (in trasparenza: la barra e le cerniere del sistema Touch)



Vista fronte, aperta



Vista fronte, aperta (in trasparenza: la barra e le cerniere del sistema Touch)



Vista retro (in trasparenza la cerniera)



Vista retro (per versione anta scorrevole verticale)

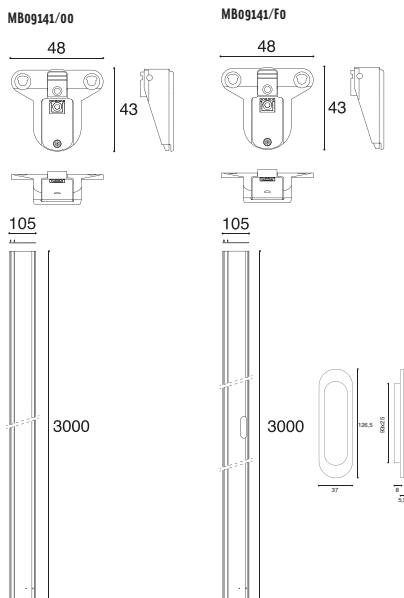

Barra alluminio satinato 50790010

Barra alluminio anodizzato 50790020

Barra grezzo 50790000

## MB09146

Design:  
Fabio Casiraghi\_Studio Nava

Materiale  
Metallo pressato fuso

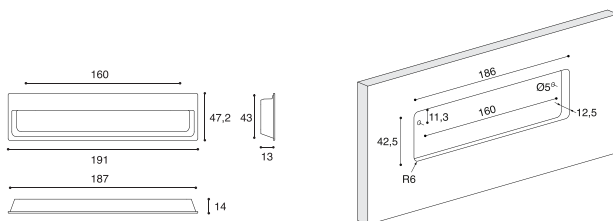

Argento 7	50228810
Cromo lucido	502288105
Nichel satinato	5022881020
Bianco	5022881025



## MB09147

Design:  
Fabio Casiraghi\_Studio Nava

Materiale  
Metallo pressato fuso

Incasso "a filo" dell'anta o "in appoggio".  
Nella finitura bianco opaco, è possibile lac-  
care in autonomia le maniglie come l'anta del  
mobile offrendo così una maggiore integra-  
zione. Poiché il fondo della maniglia è aperto  
è possibile inserire un fondo in contrasto o  
"tono su tono" con la finitura del mobile.

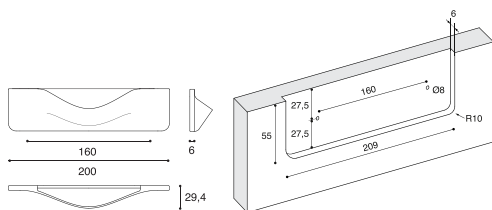

Argento 7	50229300
Cromo lucido	50229310
Bianco opaco	50229320



## MB09148

Design:  
Fabio Casiraghi\_Studio Nava

Materiale  
Metallo pressato fuso

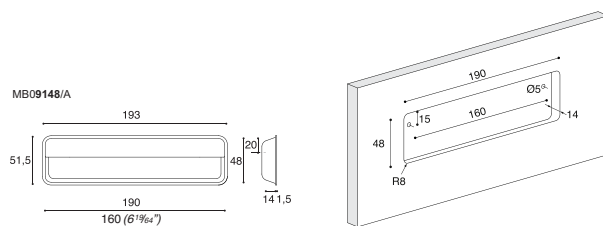

Argento 7	50230000
-----------	----------







## MS01424

Design:  
Franco Guanziroli

Materiale  
Metallo presso fuso  
Guarnizioni in fibra naturale

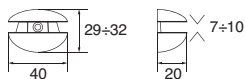

Cromo lucido	41332100
Dorato	41332110
Nichel satinato	41332120

## MS01425

Design:  
Franco Guanziroli

Materiale  
Metallo presso fuso  
Guarnizioni in politene

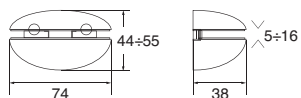

Argento 7	41331210
Bianco	41331100
Cromo lucido	41330500
Dorato	41330100
Nero	41331200
Nichel satinato	41330600

## MS01426

Design:  
Franco Guanziroli

Materiale  
Metallo presso fuso  
Guarnizioni in politene

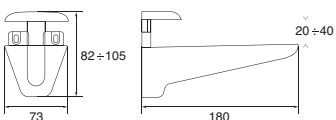

Argento 7	41333100
-----------	----------

## MS01427

Design:  
Franco Guanziroli

Materiale  
Metallo presso fuso  
Guarnizioni in politene

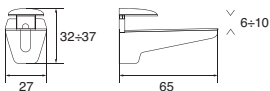

Argento 7	41334100
Cromo lucido	41334110
Dorato	41334120
Nichel satinato	41334130

## MS01430

Design:  
Mariano Ferrer

Materiale  
Metallo presso fuso  
Nylon caricato vetro  
Guarnizioni in politene

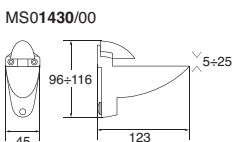

Argento 7	41320010
Bianco	41320020
Nero	41320000



# MS01100

Design:  
Carlo Bartoli

Materiale  
Metallo presso fuso

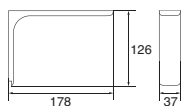

Argento 7	41310000
Bianco	41310010
Nero	41310020

# MS01220

Design:  
Paolo Nava

Materiale  
Metallo presso fuso

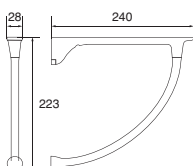

Argento 7	41337124
Cromo lucido	41335100
Dorato	41335110
Nichel "D"	41335125
Nichel satinato	41335120

# MS01221

Design:  
Paolo Nava

Materiale  
Metallo presso fuso  
Guarnizioni in politene

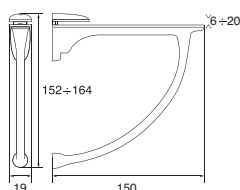

Argento 7	41336115
Cromo lucido	41336110
Dorato	41336120
Nichel satinato	41336130

# MS01222

Design:  
Paolo Nava

Materiale  
Metallo presso fuso  
Guarnizioni in politene

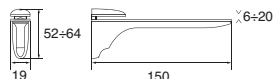

Argento 7	41335115
Cromo lucido	41337100
Dorato	41337120
Nichel satinato	41337130

# MS01300

Design:  
Carlo Bartoli

Materiale  
Metallo presso fuso  
Piastra di fissaggio: acciaio

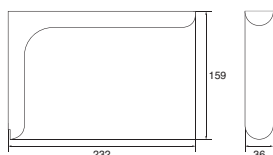

Argento 7	41315000
Bianco	41315010
Nero	41315020



## MS01424

Design:  
Franco Guanziroli

Materiale  
Metallo presso fuso  
Guarnizioni in fibra naturale

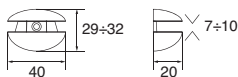

Cromo lucido	41332100
Dorato	41332110
Nichel satinato	41332120

## MS01425

Design:  
Franco Guanziroli

Materiale  
Metallo presso fuso  
Guarnizioni in politene

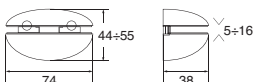

Argento 7	41331210
Bianco	41331100
Cromo lucido	41330500
Dorato	41330100
Nero	41331200
Nichel satinato	41330600

## MS01426

Design:  
Franco Guanziroli

Materiale  
Metallo presso fuso  
Guarnizioni in politene

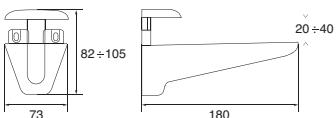

Argento 7	41333100
-----------	----------

## MS01427

Design:  
Franco Guanziroli

Materiale  
Metallo presso fuso  
Guarnizioni in politene

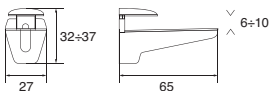

Argento 7	41334100
Cromo lucido	41334110
Dorato	41334120
Nichel satinato	41334130

## MS01430

Design:  
Mariano Ferrer

Materiale  
Metallo presso fuso  
Nylon caricato vetro  
Guarnizioni in politene

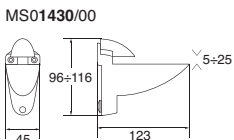

Argento 7	41320010
Bianco	41320020
Nero	41320000



# MS01431

Design:  
Alberto Meda

Materiale  
Metallo pressofuso  
Guarnizioni in politene

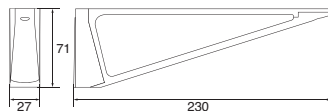

Argento 7	41338230
Cromo lucido	41338240
Nichel satinato	41338260



# MS01432

Design:  
Alberto Meda

Materiale  
Metallo pressofuso  
Guarnizioni in politene

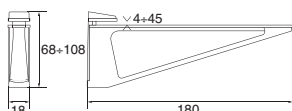

Argento 7	41338100
Nichel lucido	41338110
Nichel satinato	41338130



# MS01433

Design:  
Alberto Meda

Materiale  
metallo pressofuso  
guarnizioni in politene

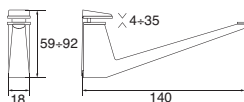

Cromo lucido	41338020
Nichel satinato	41338040



# MS01436

Design:  
Cairoli & Donzelli

Materiale  
Metallo pressofuso  
Guarnizioni in politene

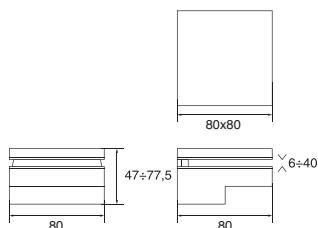

Argento 7	41334500
Nichel lucido	41334510
Nichel satinato opaco	41334520



# MS01437

Design:  
Cairoli & Donzelli  
Materiale  
Metallo pressofuso  
Guarnizioni in politene

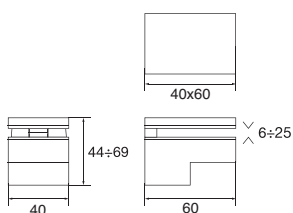

Argento 7	41334700
Nichel lucido	41334710
Nichel satinato opaco	41334720



# MS01438

Design:  
Pietro Arosio

Materiale  
Alluminio, Metallo presso fuso

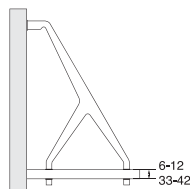

---

Argento 7 41338500

---

# MS01441

Design:  
Fabio Casiraghi\_Studio Nava

Materiale  
Metallo presso fuso

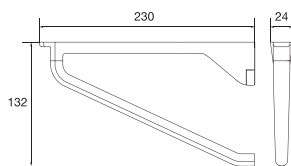

---

Cromo lucido 41338610

---

Antracite satinato 41338630

---

# MS01443

Design:  
Alberto Meda

Materiale  
metallo presso fuso  
guarnizioni in politene

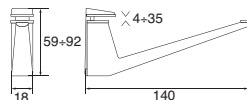

---

Cromo lucido 41338670

---

Nichel satinato 41338680

---

# CC00224

Design:  
Carlo Bartoli

Materiale  
Polipropilene

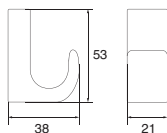

---

Bianco 53210010

---

Nero 53210020

---

# CC00231

Design:  
Carlo Bartoli

Materiale  
Polipropilene

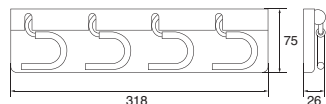

---

Bianco 53200000

---

Nero 53200010

---



## CC00301

Design:  
Luigi Caramella

Materiale  
ABS

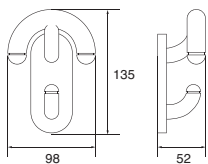

Bianco 53345010

Nero 53345020

## CC00313

Design:  
Studio Original Designers 6R5

Materiale  
Polipropilene

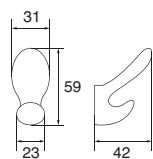

Bianco 53335010

Bianco opalino 53335040

## CC00322

Design:  
Marconato & Zappa

Materiale  
Policarbonato

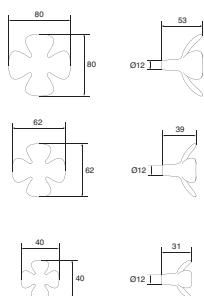

Bianco 53370000

## LID0157

Design:  
Marconato & Zappa

Materiale  
Metallo presso fuso

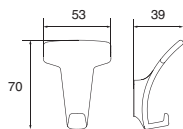

Nichel satinato lucido 53434157

## PA00255

Design:  
Carlo Bartoli

Materiale  
Metallo presso fuso

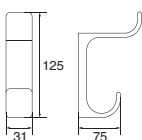

Bianco 53430010

Nero 53430020



## PA00262

Design:  
Carlo Bartoli

Materiale  
Metallo presso fuso  
Supporto: nylon

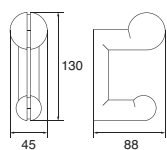

Cromo lucido	53540000
--------------	----------

## PA00263

Design:  
Luca Caramella

Materiale  
Metallo presso fuso  
Copriviti: nylon

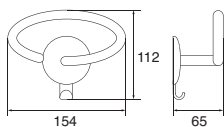

Argento 7	53371010
Cromo lucido	53371000

## PA00267

Design:  
Studio Dedali

Materiale  
Metallo presso fuso

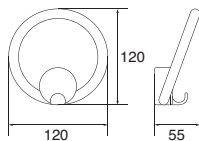

Argento 7	53372000
Cromo lucido	53372010
Nichel satinato	53372030

## PA00269

Design:  
Bartoli Design

Materiale  
Nylon caricato vetro  
Rivestito in nylon

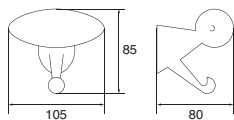

Argento 7	53374000
-----------	----------

## PA00271

Design:  
Bartoli Design

Materiale  
Metallo presso fuso

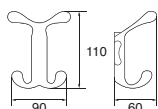

Argento 7	53375000
-----------	----------







## PA00272

Design:  
Marconato & Zappa

Materiale  
Metallo presso fuso

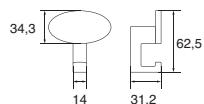

Argento 7	53432272
Cromo lucido	53432200
Dorato	53432210



## PA00273

Design:  
Marconato & Zappa

Materiale  
Metallo presso fuso

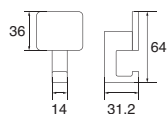

Argento 7	53433273
Cromo lucido	53433200
Dorato	53433210



## PA00274

Design:  
Bert & Bert

Materiale  
Metallo presso fuso

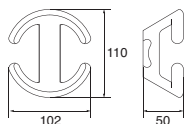

Argento 7	53376000
-----------	----------



## PA00275

Design:  
Marconato & Zappa

Materiale  
Metallo presso fuso



Argento 7	53377000
Cromo lucido	53377010
Nichel satinato	53377020



## PA00276

Design:  
Bert & Bert

Materiale  
Metallo presso fuso

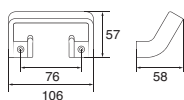

Argento 7	53378020
Cromo lucido	53378010



## PA00281

Design:  
Colombo & Vantusso

Materiale  
metallo pressofuso

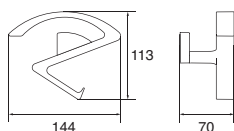

---

Argento 7	53378810
-----------	----------

---

## PA00282

Design:  
Bert & Bert

Materiale  
Metallo presso fuso

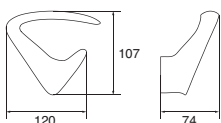

---

Argento 7	53379020
Cromo lucido	53379010

---

## PA00284

Design:  
Colombo & Vantusso

Materiale  
metallo pressofuso  
nylon

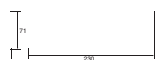

---

Argento 7	53379110
Nichel lucido	53379120

---

## PA01274

Design:  
Bert & Bert

Materiale  
Metallo presso fuso

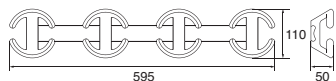

---

Argento 7	53379400
-----------	----------

---

## PA01288

Design:  
Colombo & Vantusso

Materiale  
Ganci: policarbonato  
Barra: alluminio  
Tappi laterali: nylon caricato vetro

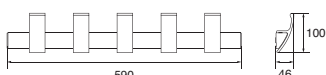

---

Bianco con ganci trasparenti	53379500
------------------------------	----------

---



# PA01291

Design:  
Marconato & Zappa

Materiale  
acciaio  
ottone

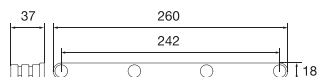

Cromo lucido	53379320
Nichel satinato	53379330
Bianco	53379340



# CF0000AH

Materiale  
Basetta in metallo presso fuso  
Vite in acciaio

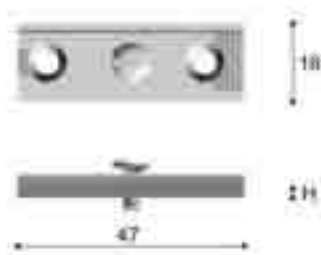

Lega	46840002
------	----------

# CF01024/5

Materiale  
Cerniera in metallo presso fuso,  
Scatola e rullino in nylon  
Perni e grani in acciaio  
Guarnizione in politene



Bronzo	46650100	46655100
Cromo lucido	46650300	46655300
Dorato	46650500	46655500
Nichel satinato	46650400	46655400
Oro satinato	46650200	46655200

CF01024



CF01025



# CF01173/4

Materiale  
Metallo presso fuso



Cromo "D" (destra)		46601010
Cromo lucido (destra)	46600010	46601020
Dorato (destra)	46600020	46601030
Cromo "D" (sinistra)		46601050
Cromo lucido (sinistra)	46600050	46601060
Dorato (sinistra)	46600060	46601070

CF01173



CF01174



# CF0305

Materiale  
Cerniera in metallo pressofuso  
Guarnizioni in politene  
Perno, molle e grani in acciaio  
Bussola in nylon

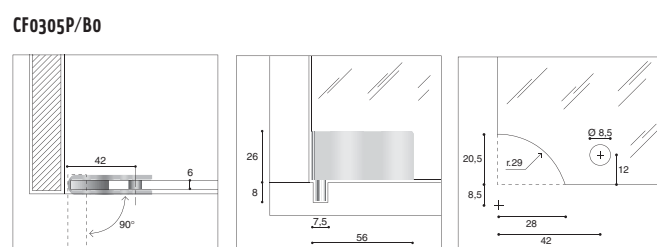

Cromo satinato	46605455
Oro satinato	46605155

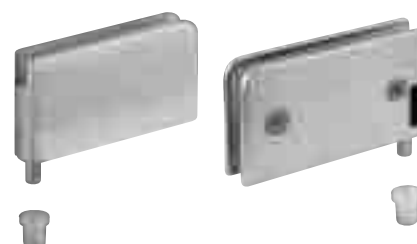

# CP00294

Materiale  
Cerniera in ottone  
Perno in acciaio



Nichel lucido	46490540
Oro lucido	46490140

# MA00604

Design:  
Paolo Nava

Materiale  
Stelo e puntale in alluminio  
Vite in acciaio

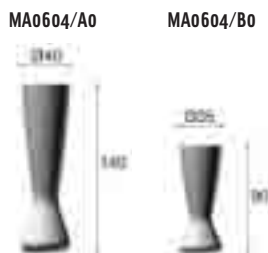

Alluminio lucido	41915140	41915090
------------------	----------	----------

# MA00607

Materiale  
Alluminio  
Vite in acciaio



Alluminio lucidato	41920607
--------------------	----------

# MA00608

Materiale  
Piastra in alluminio  
Vite in acciaio

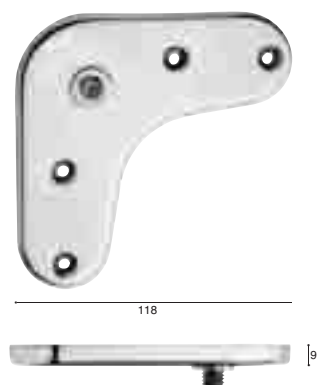

Alluminio lucidato	41920608
--------------------	----------

# MA00628

Design:  
Paolo Nava

Materiale  
Alluminio

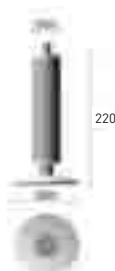

Alluminio lucidato	41918226
--------------------	----------

# MA00648

Design:  
Alexander Lervik

Materiale  
Metallo presso fuso  
Polimero morbido

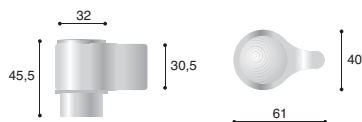

Argento 7	29534100
Cromo lucido	29534110

# MA00650-1

Design:  
Paolo Nava

Materiale  
Stelo, puntale e piastra in alluminio,  
Vite in acciaio

**Note** Piastra di fissaggio integrata provvista di fori per viti mordenti.

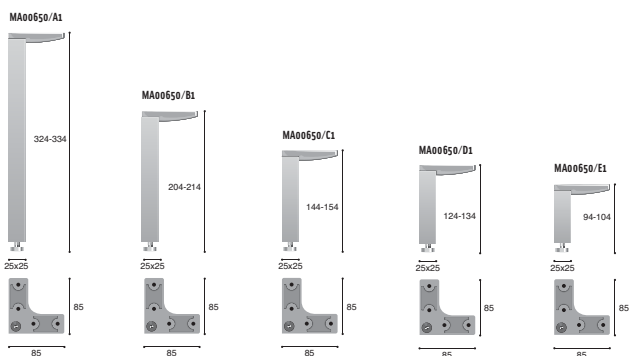

Alluminio lucido	41921000	41921010	41921020	41921030	41921040
Argento 7	41921100	41921110	41921120	41921130	41921140



# MA00652

Design:  
Paolo Nava

Materiale  
Metallo presso fuso

**Note** Piedino regolabile grazie al puntale di appoggio che consente un'escursione di mm 10.

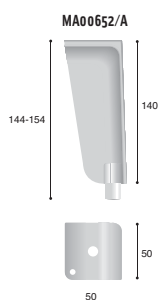

Argento 7	41924140
-----------	----------



# MA00653

Design:  
Paolo Nava

Materiale  
Metallo presso fuso

**Note** Piedino regolabile. L'escursione di regolazione è pari a mm 30, resa possibile con lo scorrimento della parte inferiore del piedino, così da garantire una continuità della linea del piedino stesso, senza stacchi tra il piedino e il pavimento.

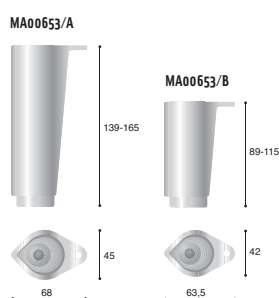

Argento 7	41922140	41922090
-----------	----------	----------



# MA01003

Materiale  
Guide scorrevoli in acciaio  
Supporti in nylon

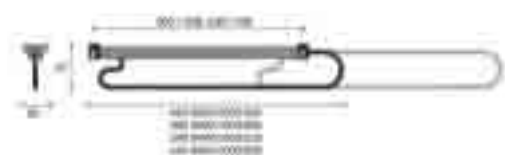

Bianco	43811010	43810010	43811110	43811210
Nero opaco	43811020	43810020	43811120	43811220
Marrone	Su ordinazione	43810060	Su ordinazione	Su ordinazione

# MA01009

Design:  
Carlo Bartoli

Materiale  
Tubo in acciaio  
Base in nylon

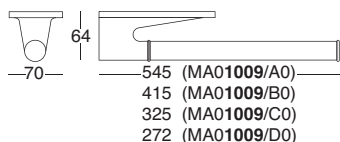

Inox lucido	43811530	43811630	43811730	43811830
Bianco	43811510	43811610	43811710	43811810



# MA01182

Materiale  
Borchia in acciaio inox o ottone  
Scatola in nylon

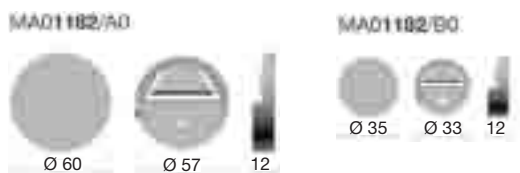

Inox lucido	41330000	41330050
Oro lucido	Su ordinazione	41330060



# MA00551/2

Design:  
Paolo Nava

Materiale  
Corpo: metallo presso fuso  
Barra: acciaio, Appoggio: nylon

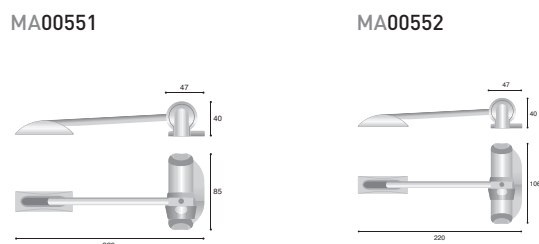

Argento 7	29618100	29619100
Bianco opaco	29618150	29619150



# MA01135/6

Design:  
Paolo Nava

Materiale  
Metallo presso fuso  
Polimero morbido

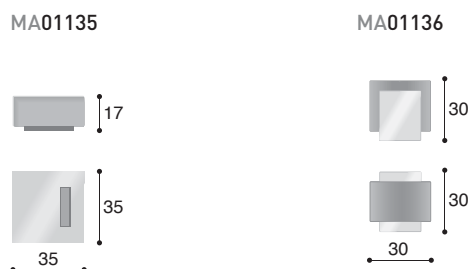

Argento 7	29534400	29534300
Cromo lucido	29534410	29534310



# MA01185

Materiale  
ganci e vite in acciaio  
scatola in nylon

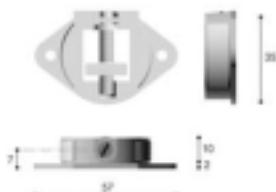

Nero	48542300
------	----------

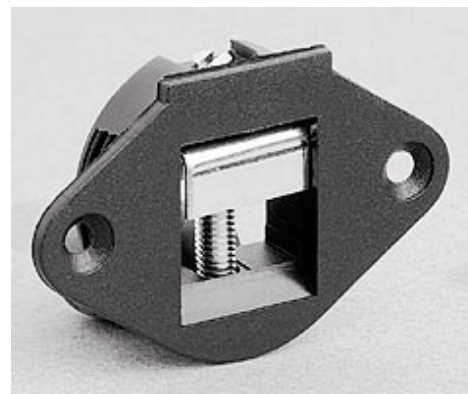

# MA01056

## Materiale

Perno e spirale in acciaio  
 Scatola in metallo presso fuso  
 Tappo di copertura in nylon

## Giunto brevettato

particolarmente indicato per l'assemblaggio di letti, tavoli (in legno o metallo) e, in genere, per tutti i casi dove è importante un bloccaggio perfetto, sicuro e con una forte tenuta. Il giunto consente un tiraggio costante e continuo anche nel caso di piccoli errori di posizionamento o di foratura.

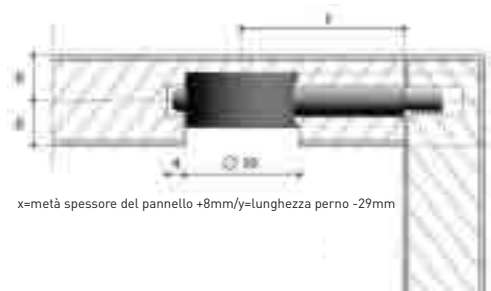

## Esempi di utilizzo



### MA01056/00



### Perno 7/16"



### Perno M8



### MA01056/T1

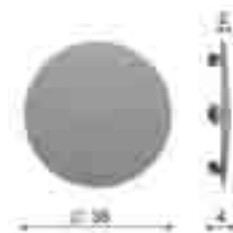

41927035	Su ordinazione	Su ordinazione	Bianco
	Su ordinazione	41927064	Marrone

# MA01187

Design:  
 Paolo Nava

Materiale  
 ganci e vite in acciaio  
 scatola in nylon

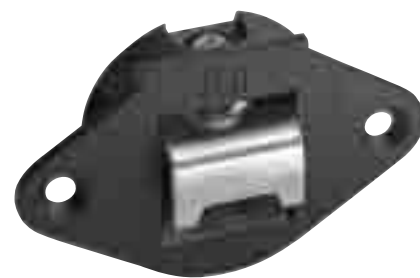
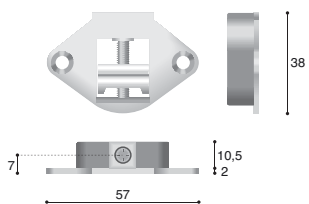

Nero	48542350
------	----------

# MA01188

Design:  
 Paolo Nava

Materiale  
 Metallo presso fuso  
 Polimero morbido

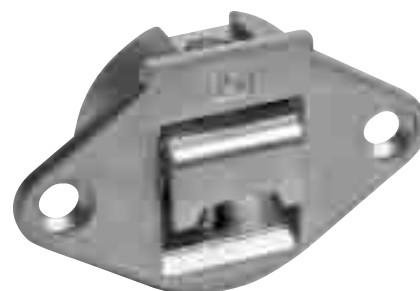
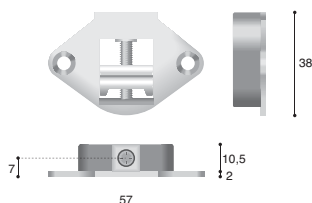

Zincato lucido	48542400
----------------	----------

**Sede Bologna**

Tel. 051.321121  
Via Brini, 2 - 40128 (BO)  
Fax Uff. Vendite 051.4173595  
Fax Amm.ne 051.328018  
info@ferexpert.it

[www.ferexpert.it](http://www.ferexpert.it) [info@ferexpert.it](mailto:info@ferexpert.it)

**Filiale Ferrara**

Tel. 0532.92556  
Via Bologna, 453 - 44124 (FE)  
Presso BETA CENTER  
Fax 0532.92445  
infoferrara@ferexpert.it

**Filiale Romagna**

Tel. 0543.725083  
Via G. Palatucci, 7  
40122 Forlì  
Fax 0543.774972  
infoforli@ferexpert.it

**Filiale Verona**

Tel. 045.917987  
Via Nassar, 50/A - 37026 (VR)  
Settimo di Pescantina  
Fax 045.8350162  
infoverona@ferexpert.it

**Filiale Modena**

Tel. 059.280317  
Via W.A Mozart, 52  
41122 Modena  
Fax 059.285572  
Infomodena@ferexpert.it



# CONFALONIERI