

## ROSTRI

### Funzioni

I rostri permettono di creare punti di chiusura supplementari su qualsiasi infisso in alluminio, rendendo più robusta tutta la struttura dell'infisso.

Scheda tecnica on-line



04358

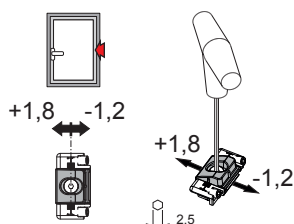
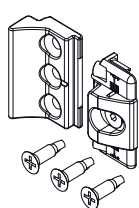

01350K

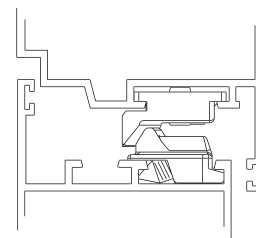
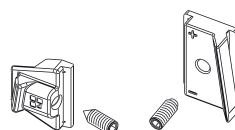

0135701

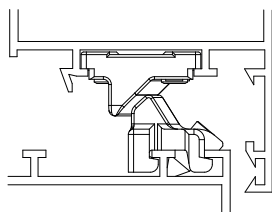
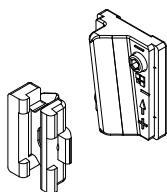

01374K

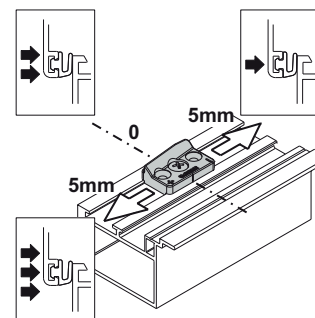
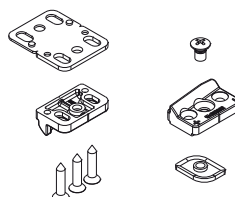

01391

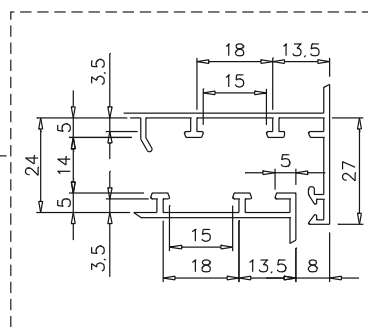
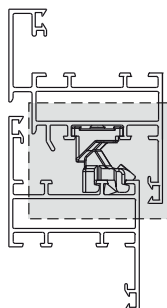
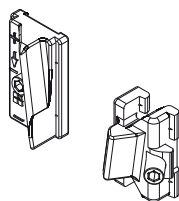

Codice	Descrizione	NODO	Base Grezzo	Anodizzato Elox	Verniciato	Trend/Oro Ottone	Pezzi per confezione
01350K	ROSTRO FUTURA	C001-C002-C003-C004-C005-C006-C011-C012-C013-C014-C015-C016-C017	X				50
0135701	ROSTRO DI CHIUSURA REGISTRABILE	C008	X				50
01374K	ROSTRO PER FACCIATA CONTINUA	-	X				50
01391	ROSTRO DI CHIUSURA REGISTRABILE	C007	X				50
04358	ROSTRO CHIC	C001-C002-C003-C004-C005-C006	X				50