

**CERNIERE ANTA RIBALTA
FUTURA 3D 130**

04711

Funzioni

Gruppo cerniere (superiore e inferiore) necessarie per la realizzazione di un infisso Anta Ribalta Futura 3D 130.

Finiture

Verniciata nei colori RAL

Confezioni

Scatola da 10 pezzi

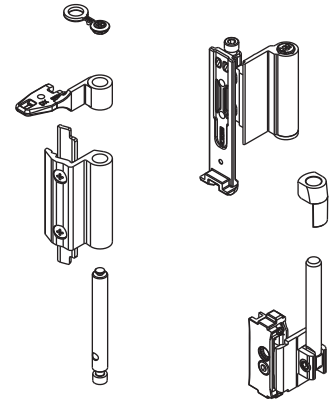

L'Anta Ribalta FUTURA 3D 130 è classificata per 130 Kg.

E' comunque possibile realizzare anche infissi con peso fino a 140 Kg. E' disponibile in due versioni, tradizionale **FUTURA 3D 130** e logica **FUTURA 3D 130 lgc**.

Per le dimensioni minime e massime realizzabili e per il relativo vetro da utilizzare si faccia sempre riferimento alle tabelle riportate a fianco.

1	2	3	4	5	6	7	8	9
-	4	130	0	1	4	-	8	1300/1200

sistema di codifica in accordo con norma:
EN13126-8:2006 e QM328

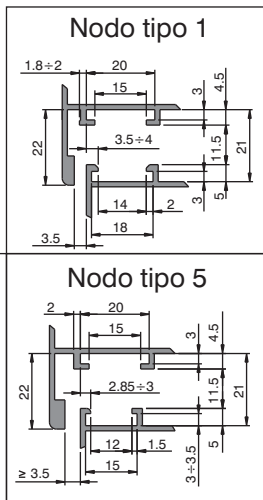
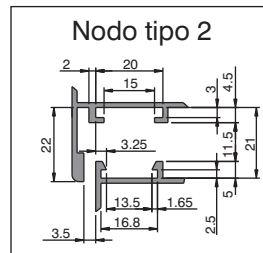

Meccanismo di chiusura per cremonese	04704	04704	04706N	04706N
Meccanismo di chiusura per martellina	04705N	04705N	04707V	04707V
Cerniere	04711	04711	04711	04711
Braccio tipo 1	04200	04284	04202	04344
Braccio tipo 2	04201	04285	04203	04345
Cremonese	01033K	01039	01192	01194
Martellina	02484	02488	02486	-

	FUTURA 3D 130	FUTURA 3D 130 micro	FUTURA 3D 130 lgc	FUTURA 3D 130 micro lgc
Meccanismo di chiusura per cremonese	04704	04704	04706N	04706N
Meccanismo di chiusura per martellina	04705N	04705N	04707V	04707V
Cerniere	04711	04711	04711	04711
Braccio tipo 1	04200	04284	04202	04344
Braccio tipo 2	04201	04285	04203	04345
Cremonese	01033K	01039	01192	01194
Martellina	02484	02488	02486	-

Tabella del massimo spessore del vetro realizzabile

3000	35	28	24	21	19	17	15	14	13	12	11	11	10	
2900	35	29	25	22	20	18	16	15	14	13	12	11	10	
2800	36	30	26	23	20	18	17	15	14	13	12	11	10	
2700	38	31	27	24	21	19	17	16	15	13	12	11	10	
2600	39	33	28	25	22	20	18	16	15	14	13	12	11	
2500	44	37	31	27	24	22	20	18	17	16	15	14	13	
2400	46	38	33	29	25	23	21	19	18	16	15	14	13	
2300	48	40	34	30	27	24	22	20	18	17	16	15	14	
2200	50	42	36	31	28	25	23	21	19	18	17	16	15	
2100	50	44	37	33	29	26	24	22	20	19	17	16	15	
2000	50	46	39	34	31	27	25	23	21	20	18	17	16	
1900	50	48	41	36	32	29	26	24	22	21	19	18	16	
1800	50	50	44	38	34	31	28	25	23	22	20	18	16	
1700	50	50	46	40	36	32	29	27	25	23	21	18	16	
1600	50	50	49	43	38	34	31	29	26	24	21	18	16	
1500	50	50	50	46	41	37	33	31	27	24	21	18	16	
1400	50	50	50	49	44	39	36	32	27	24	21	18	16	
1300	50	50	50	50	47	42	38	32	27	24	21	18		
1200	50	50	50	50	50	46	38	32	27	24	21			
1100	50	50	50	50	50	46	38	32	27	24				
1000	50	50	50	50	50	46	38	32	27					
900	50	50	50	50	50	46	38	32						
800	50	50	50	50	50	46	38							
700	50	50	50	50	50	46								
600	50	50	50	50	50	46								
	390	600	700	800	900	1000	1100	1200	1300	1400	1500	1600	1700	1800

Tabella portata massima realizzabile

3000	130	130	130	130	130	130	130	130	130	130	130	130	130	130
2900	130	130	130	130	130	130	130	130	130	130	130	130	130	130
2800	130	130	130	130	130	130	130	130	130	130	130	130	130	130
2700	130	130	130	130	130	130	130	130	130	130	130	130	130	130
2600	130	130	130	130	130	130	130	130	130	130	130	130	130	130
2500	140	140	140	140	140	140	140	140	140	140	140	140	140	130
2400	140	140	140	140	140	140	140	140	140	140	140	140	140	130
2300	140	140	140	140	140	140	140	140	140	140	140	140	140	130
2200	140	140	140	140	140	140	140	140	140	140	140	140	140	130
2100	140	140	140	140	140	140	140	140	140	140	140	140	140	130
2000	140	140	140	140	140	140	140	140	140	140	140	140	140	130
1900	140	140	140	140	140	140	140	140	140	140	140	140	140	125
1800	140	140	140	140	140	140	140	140	140	140	140	140	140	118
1700	140	140	140	140	140	140	140	140	140	140	140	140	133	112
1600	140	140	140	140	140	140	140	140	140	140	140	134	126	118
1500	140	140	140	140	140	140	140	140	140	140	135	126	118	111
1400	140	140	140	140	140	140	140	140	140	137	127	118	111	104
1300	140	140	140	140	140	140	140	140	140	140	138	127	118	104
1200	140	140	140	140	140	140	140	140	140	140	128	118	110	103
1100	140	140	140	140	140	140	140	129	118	109	101	95		
1000	140	140	140	140	140	140	130	118	108	100	93			
900	140	140	140	140	131	118	108	99	91					
800	140	140	140	133	118	106	97	89						
700	140	140	135	118	105	95	86							
600	140	138	118	104	92	83								
	390	600	700	800	900	1000	1100	1200	1300	1400	1500	1600	1700	1800

FUTURA 3D
130

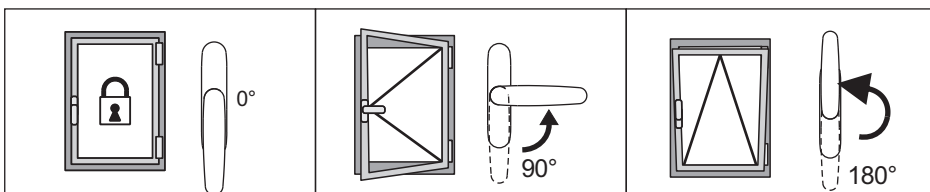
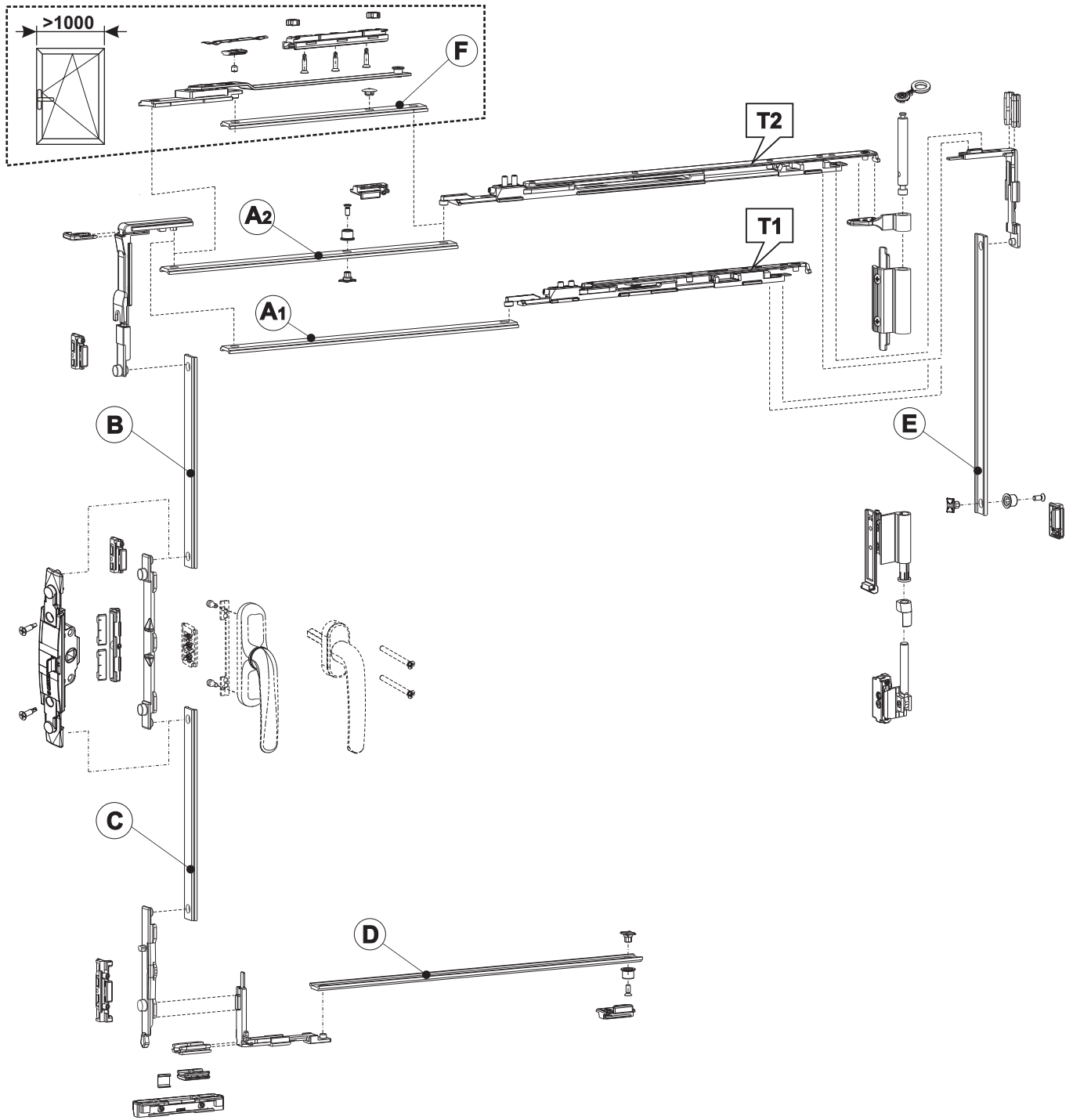

FUTURA 3D

130 micro

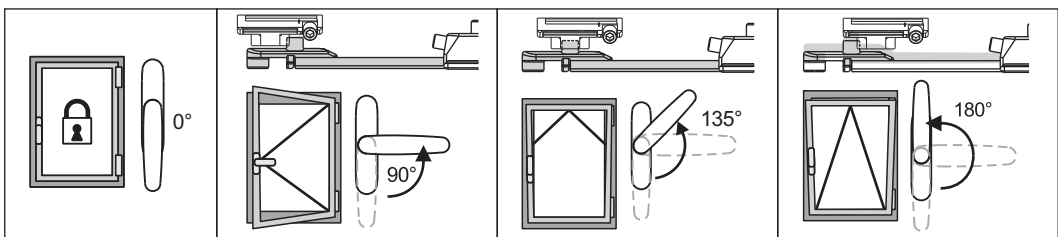
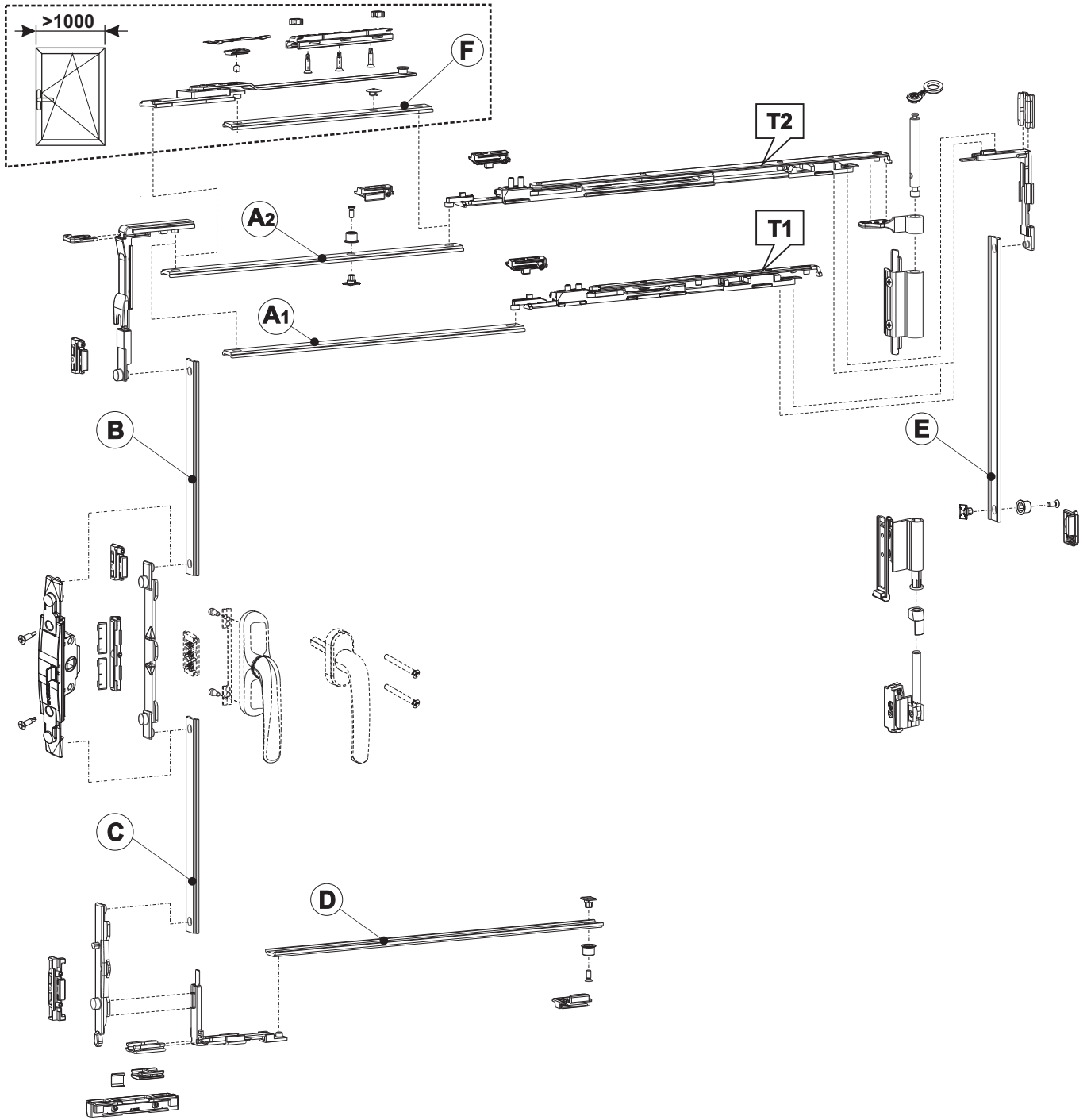

FUTURA 3D

130 lgc

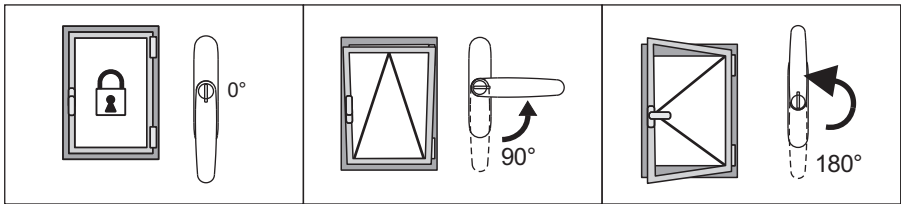
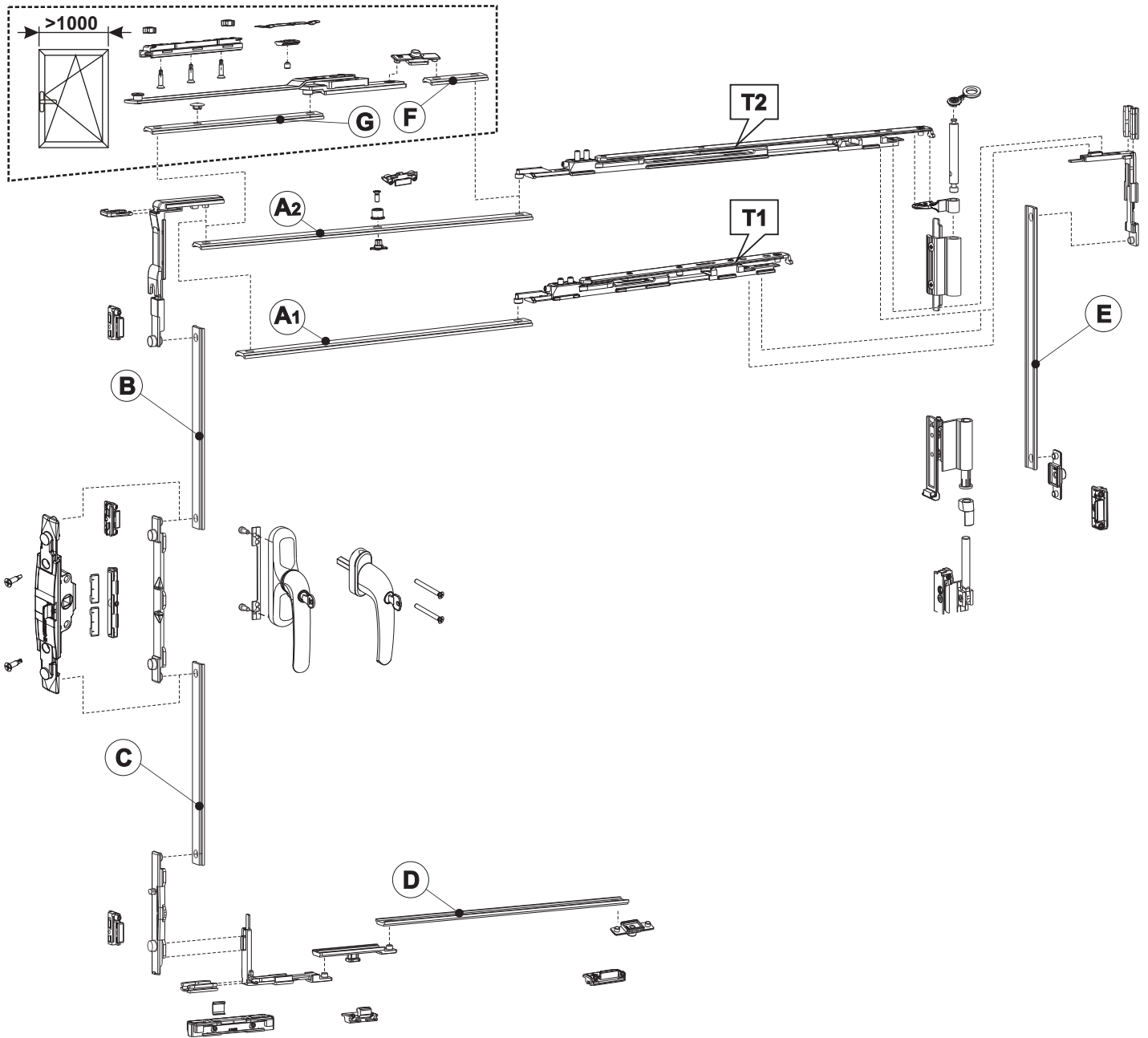

FUTURA 3D

130 micro lgc

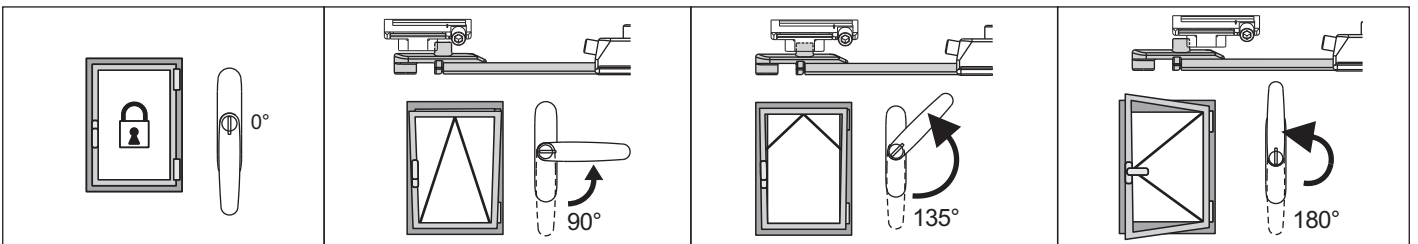
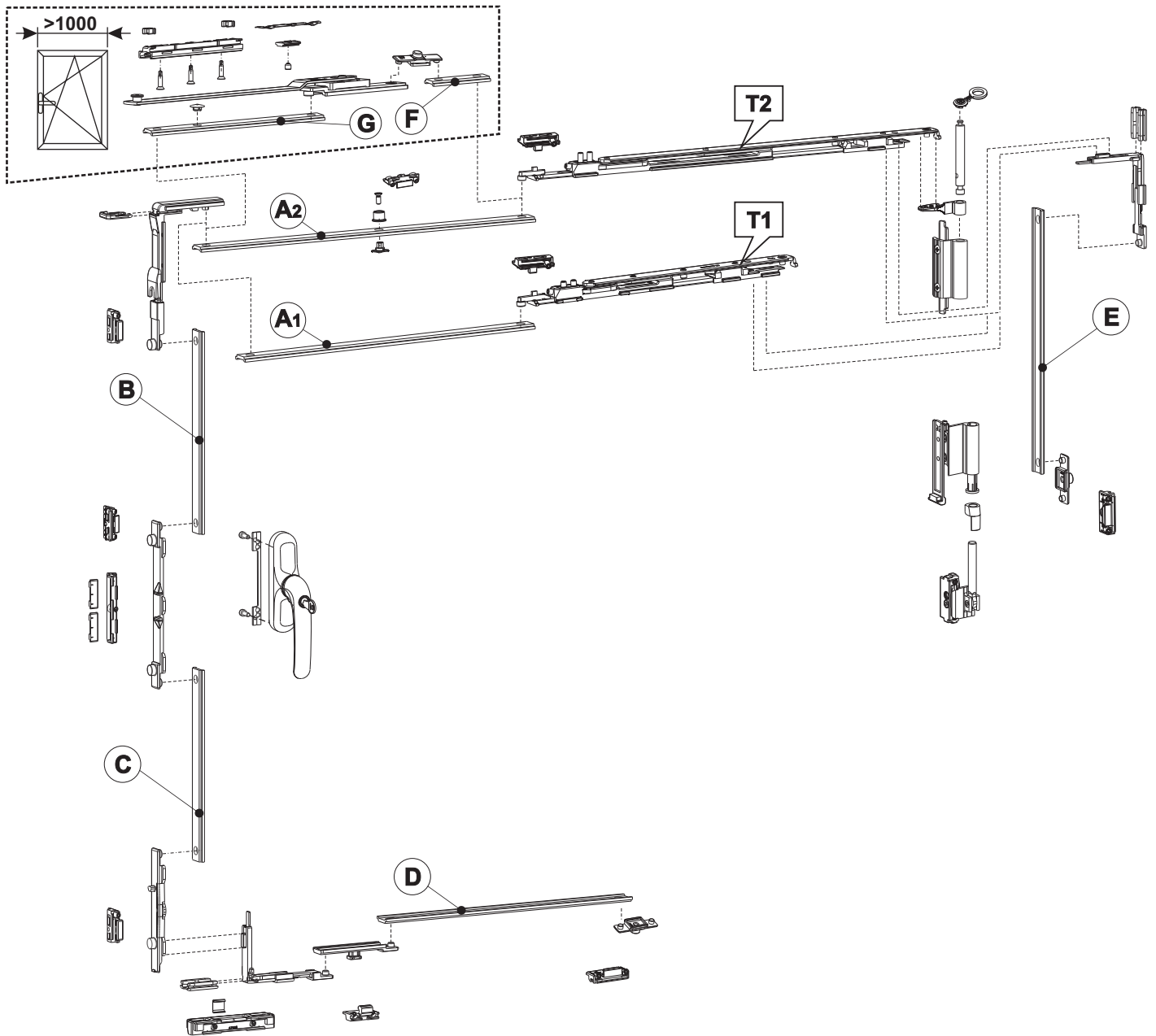

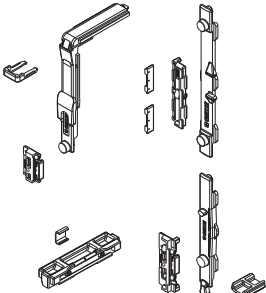
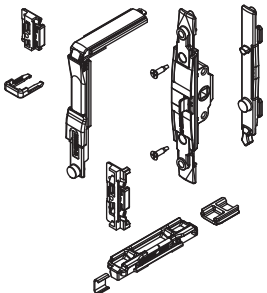
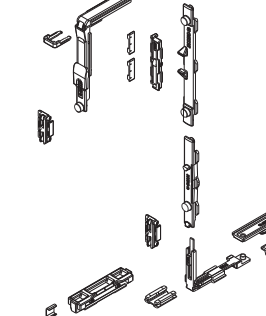
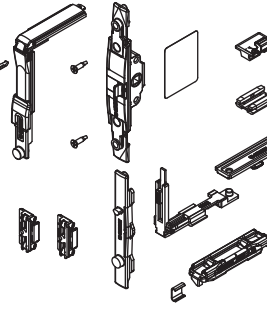
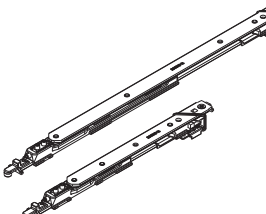
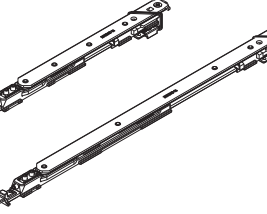
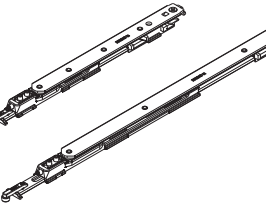
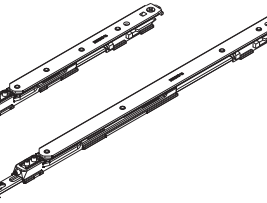
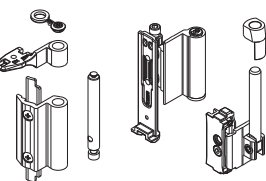
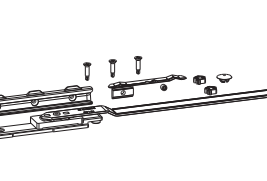
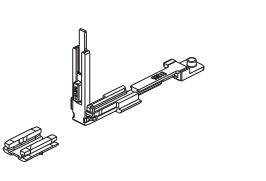
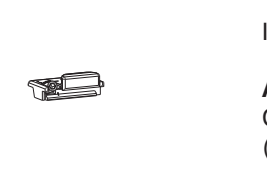
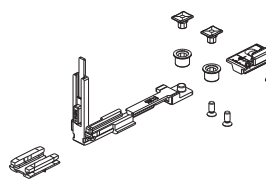
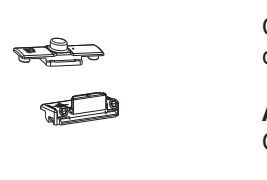
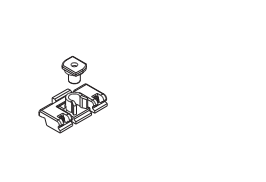
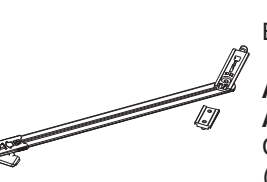
	<p>MECCANISMO CHIUSURA A/R</p> <p>Art. 04704 Confezioni: 10 pezzi</p>		<p>MECCANISMO CHIUSURA A/R CON MOVIMENTAZIONE M180</p> <p>Art. 04705N Confezioni: 10 pezzi</p>
	<p>MECCANISMO CHIUSURA A/R LOGICA</p> <p>Art. 04706N Confezioni: 10 pezzi</p>		<p>MECCANISMO CHIUSURA A/R LOGICA CON MOVIMENTAZIONE M180</p> <p>Art. 04707V Confezioni: 10 pezzi</p>
	<p>BRACCIO FUTURA 3D MICROVENTILAZIONE 130</p> <p>Art. 04284 (T1 - L=410÷700) Art. 04285 (T2 - L=701÷1800) Confezioni: 10 pezzi</p>		<p>BRACCIO FUTURA 3D MICROVENTILAZIONE 130 LGC</p> <p>Art. 04344 (T1 - L=410÷700) Art. 04345 (T2 - L=701÷1800) Confezioni: 10 pezzi</p>
	<p>BRACCIO FUTURA 3D 130</p> <p>Art. 04200 (T1 - L=390÷700) Art. 04201 (T2 - L=701÷1800) Confezioni: 10 pezzi</p>		<p>BRACCIO FUTURA 3D 130 LGC</p> <p>Art. 04202 (T1 - L=390÷700) Art. 04203 (T2 - L=701÷1800) Confezioni: 10 pezzi</p>
	<p>CERNIERE AR FUTURA 3D 130</p> <p>Art. 04711 Confezioni: 10 pezzi</p>		<p>BRACCIO SUPPLEMENTARE FUTURA</p> <p>Art. 04301K (L>1000) Confezioni: 5 pezzi</p>
	<p>RINVIO D'ANGOLO (*)</p> <p>Art. 04024K Confezioni: 10 pezzi (*) vedi scheda tecnica specifica</p>		<p>INCONTRO REGISTRABILE (*)</p> <p>Art. 01353K Confezioni: 200 pezzi (*) vedi scheda tecnica specifica</p>
	<p>CHIUSURE SUPPLEMENTARI</p> <p>Art. 04770K (H>1200 L>1000) Confezioni: 10 pezzi</p>		<p>CHIUSURA SUPPLEMENTARE LGC da abbinare con Art. 04024K</p> <p>Art. 04777K Confezioni: 50 pezzi</p>
	<p>FERMA ANTA (*)</p> <p>Art. 02199 Confezioni: 50 pezzi (*) vedi scheda tecnica specifica</p>		<p>BRACCIO LIMITATORE (*)</p> <p>Art. 02030K Art. 02031K Confezioni: 10 pezzi (*) vedi scheda tecnica specifica</p>

	<p>MARTELLINA PRIMA KEY</p> <p>Art. 02485 Confezioni: 5 pezzi</p> <p>Art. 02486 LGC Confezioni: 5 pezzi</p>	<p>KIT CERNIERE ANTA ABBINATA FUTURA 3D 130</p> <p>Art. 04715 Confezioni: 5 pezzi</p>
	<p>MARTELLINA PRIMA</p> <p>Art. 02484 Prima Confezioni: 10 pezzi</p> <p>Art. 02481 Prima in ottone Confezioni: 10 pezzi</p> <p>Art. 02488 Prima micro Confezioni: 10 pezzi</p>	<p>CATENACCIO GIAP ANTA ABBINATA AD ANTA RIBALTA H > 600</p> <p>Art. 04274K Confezioni: 10 pezzi</p> <p>Art. 04277K Confezioni: 10 pezzi</p> <p>Art. 04278K Confezioni: 10 pezzi</p>
	<p>CREMONESE EURO</p> <p>Art. 01090K Confezioni: 10 pezzi</p> <p>Art. 01094 Euro micro Confezioni: 10 pezzi</p>	<p>CATENACCIO REGOLABILE H > 630</p> <p>Art. 02168K Confezioni: 10 pezzi</p> <p>Art. 02166K Confezioni: 10 pezzi</p>
	<p>CREMONESE PRIMA</p> <p>Art. 01033K Prima Confezioni: 10 pezzi</p> <p>Art. 01039 Prima micro Confezioni: 10 pezzi</p> <p>Art. 01135K Prima in ottone Confezioni: 5 pezzi</p> <p>Art. 01120 Prima micro in ottone Confezioni: 5 pezzi</p>	<p>CATENACCIO INCA ANTA ABBINATA AD ANTA RIBALTA H > 720</p> <p>Art. 04282K Confezioni: 5 pezzi</p> <p>Art. 04287 Confezioni: 5 pezzi</p>
	<p>CREMONESE PRIMA KEY</p> <p>Art. 01191 - Prima Key Confezioni: 5 pezzi</p> <p>Art. 01192 - Prima Key Capture Igc 104-92 Confezioni: 5 pezzi</p> <p>Art. 01193 - Prima Key Capture Igc 98-84 Confezioni: 5 pezzi</p> <p>Art. 01194 - Prima Key Capture micro 104-92 Confezioni: 5 pezzi</p> <p>Art. 01195 - Prima Key Capture micro 98-84 Confezioni: 5 pezzi</p>	<p>DIMA</p> <p>Art. 03520 Confezioni: 20 pezzi</p>