

## BOCCOLE



### Funzioni

Particolare da inserire a pressione sul bancale di una finestra o di una porta in alluminio scorrevole per il deflusso dell'acqua.

### Materiali

Poliammide nera

Scheda tecnica  
on-line



02367

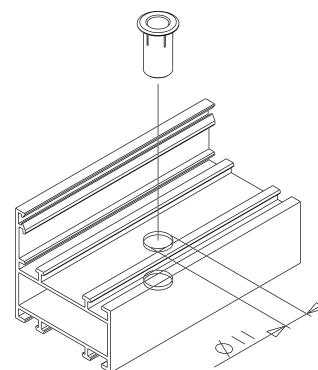
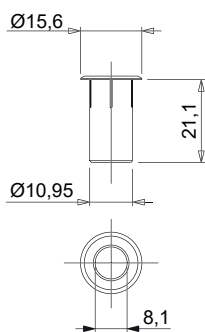
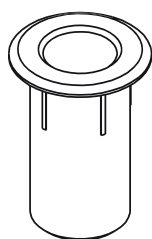

03156

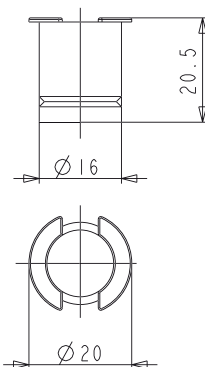
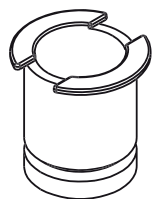

03196

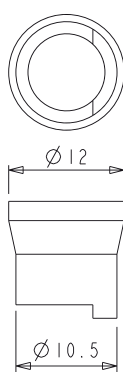
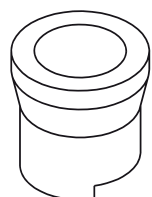

In alcune serie è necessario, all'atto del montaggio, asportare la parte terminale in corrispondenza delle linee di frattura prestabilita.



| Codice | Descrizione               | Nota | Base Grezzo | Anodizzato Elox | Verniciato | Trend/Oro Ottone | Pezzi per confezione |
|--------|---------------------------|------|-------------|-----------------|------------|------------------|----------------------|
| 02367  | BOCCOLA DRENAGGIO BANCALE |      | X           |                 |            |                  | 500                  |
| 03156  | BOCCOLA SCOLO ACQUA       |      | X           |                 |            |                  | 100                  |
| 03196  | BOCCOLA SCOLO ACQUA       |      | X           |                 |            |                  | 100                  |