

ROSTRI



Funzioni

I rostri permettono di creare punti di chiusura supplementari su qualsiasi infisso in alluminio, rendendo più robusta tutta la struttura dell'infisso.

Scheda tecnica on-line



04358

Regolazione compressione

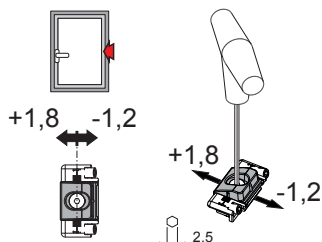
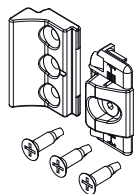

01350K

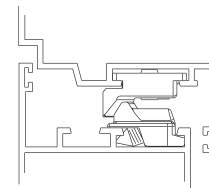
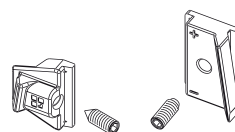

0135701

01391

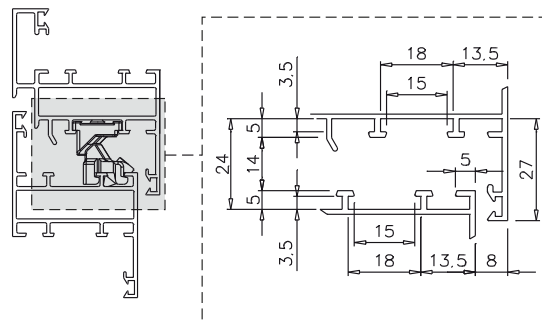
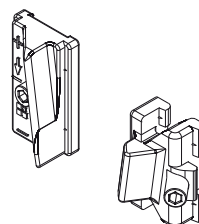
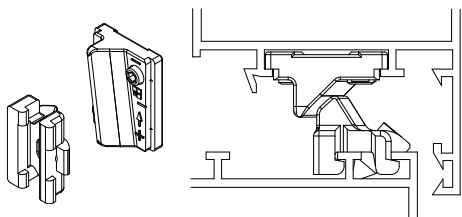

05288

Regolazione compressione

05294

Regolazione compressione

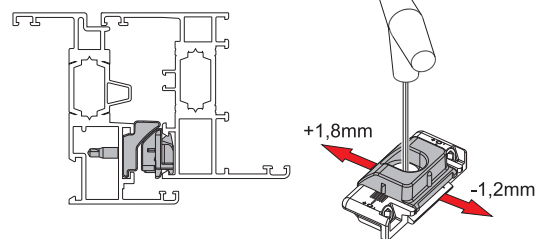
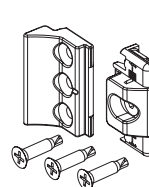
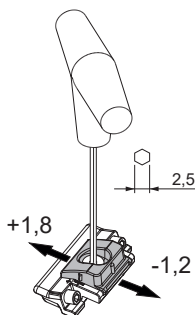
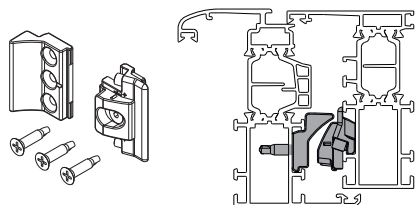

Codice	Descrizione	NODO	Abbinabile con	Base Grezzo	Anodizzato Elox	Verniciato	Trend/Oro Ottone	Pezzi per confezione
01350K	ROSTRO FUTURA	C001-C002-C003-C004-C005-C006-C011-C012-C013-C014-C015-C016-C017	FLASH, FUTURA	X				50
0135701	ROSTRO DI CHIUSURA REGISTRABILE	C008	FLASH, FUTURA, FULCRA, CELERA	X				50
01391	ROSTRO DI CHIUSURA REGISTRABILE	C007	FLASH, FUTURA, FULCRA, CELERA	X				50
04358	ROSTRO CHIC	C001-C002-C003-C004-C005-C006	CHIC	X				50
05288	CHIC - ROSTRO DI CHIUSURA REGOLABILE	C007	CHIC	X				25
05294	ROSTRO DI CHIUSURA REGISTRABILE	C001-C002-C003-C004-C005-C006-C011-C012-C013-C014-C015-C016-C017	FLASH, FUTURA, FULCRA, CELERA, BRACCI CAMERA EUROPEA	X				50