







Fitting for pivoting and lateral sliding in of wooden doors up to 35 kg (77 lbs.). Uniform, flush front design with even gap pattern. Push-to-open function for handle-less cabinet designs.

Product highlights

-  **Productivity** Easy installation thanks to high degree of pre-assembly with intuitive adjustment
-  **Comfort** Ergonomic movement support for even, smooth movement
-  **Aesthetics** Cabinet designs without handle – the technology remains invisible

Technical specifications

-  10–35 kg (22 to 77 lbs.)
-  1900–2700 mm (6' 2 13/16" to 8' 10 5/16")
-  440–750 mm (1' 5 5/16" to 2' 5 17/32")
-  18–26 mm (23/32" to 1 1/32")

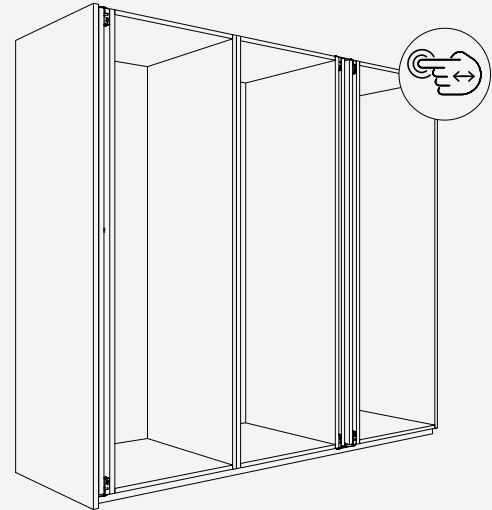

Installation examples

Door striking against the top and bottom cabinet sections

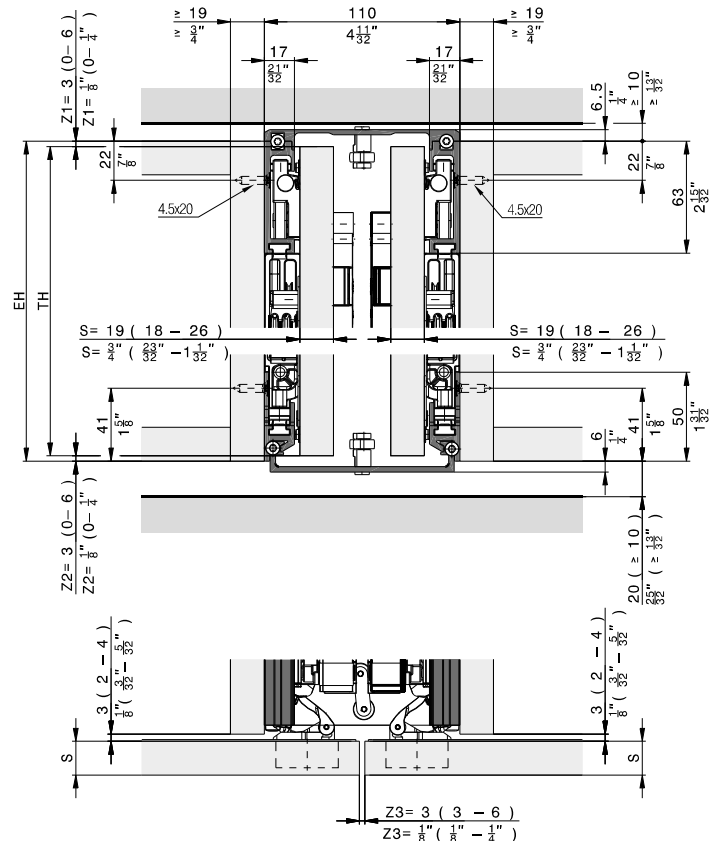
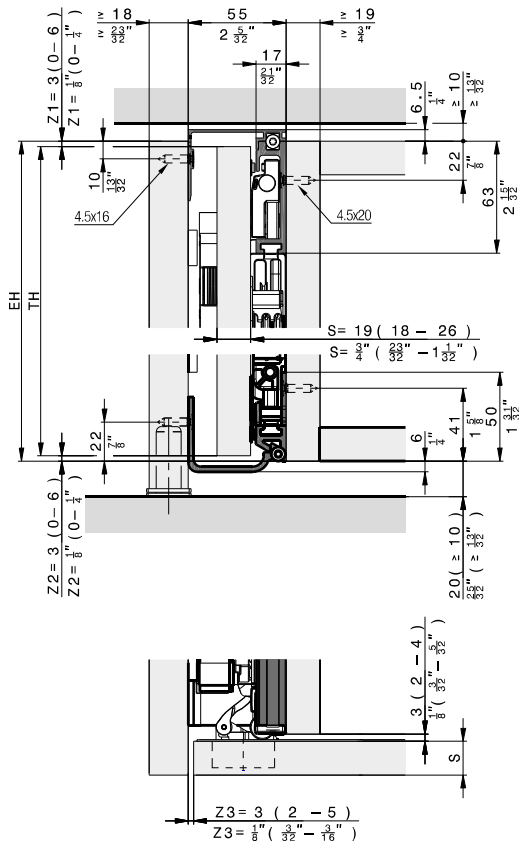

Components required for one cabinet

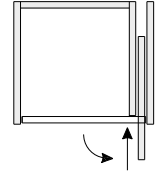
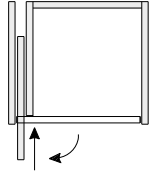

Hawa Concepta III 35 Push, left

	No.
Hawa Concepta III 35, basic set left, door height 1900–2700 mm (6' 2 13/16" to 8' 10 5/16")	30996
Hawa Concepta III 25/35, Push slide-in set, left	30998
Upright profile L= 2474 mm (8' 1 13/32"), for door height 1900–2700 mm (6' 2 13/16" to 8' 10 5/16"), aluminum, anodized	30771

Hawa Concepta III 35 Push, right

	No.
Hawa Concepta III 35, basic set right, door height 1900–2700 mm (6' 2 13/16" to 8' 10 5/16")	30997
Hawa Concepta III 25/35, Push slide-in set, right	30999
Upright profile L= 2474 mm (8' 1 13/32"), for door height 1900–2700 mm (6' 2 13/16" to 8' 10 5/16"), aluminum, anodized	30771

Weight and door size ratio calculations

The maximum weight must be adapted depending on the door size ratio.

		DE Türbreite / FR Largeur de porte / EN Door width / IT Larghezza anta / ES Ancho de puerta										
		440	500	550	600	650	700	750				
DE Türhöhe / FR Hauteur de porte / EN Door height / IT Altezza anta / ES Altura de puerta	2700	35	35	35	35	35	35	35	35	DE Maximale Gewichte in kg / FR Poids maximale en kg / EN Maximum weights in kg / IT Pesì massimo in kg / ES Pesos máximos en kg	DE Maximale Gewichte in lbs. / FR Poids maximale en lbs. / EN Maximum weights in lbs. / IT Pesì massimo in lbs. / ES Pesos máximos en lbs.	
	2650	35	35	35	35	35	35	35	35			
	2600	35	35	35	35	35	35	35	35			
	2550	35	35	35	35	35	35	35	35			
	2500	35	35	35	35	35	35	35	35			
	2450	35	35	35	35	35	35	35	34			
	2400	35	35	35	35	35	35	35	33			
	2350	35	35	35	35	35	35	34	32			
	2300	35	35	35	35	35	35	34	31			
	2250	35	35	35	35	35	35	33	31			
	2200	35	35	35	35	34	32	30	30			
	2150	35	35	35	35	33	31	29	29			
	2100	35	35	35	35	32	30	28	28			
	2050	35	35	35	34	31	29	27	27			
	2000	35	35	35	33	30	28	26	26			
	1950	35	35	35	32	29	27	26	26			
1900	35	35	34	31	29	27	25	25				
		DE Türgewicht in kg / FR Poids de porte en kg / EN Door weight in kg / IT Peso anta in kg / ES Peso de puerta en kg										
		DE Türgewicht in lbs. / FR Poids de porte en lbs. / EN Door weight in lbs. / IT Peso anta in lbs. / ES Peso de puerta en lbs.										
		1' 5 5/16"	1' 7 11/16"	1' 9 21/32"	1' 11 5/8"	2' 1 19/32"	2' 3 9/16"	2' 5 17/32"				
8' 10 5/16"	77	77	77	77	77	77	77	77				
8' 8 11/32"	77	77	77	77	77	77	77	77				
8' 6 3/8"	77	77	77	77	77	77	77	77				
8' 4 13/32"	77	77	77	77	77	77	77	77				
8' 2 7/16"	77	77	77	77	77	77	77	77				
8' 0 15/32"	77	77	77	77	77	77	77	75				
7' 10 1/2"	77	77	77	77	77	77	77	73				
7' 8 17/32"	77	77	77	77	77	77	75	71				
7' 6 9/16"	77	77	77	77	77	77	75	68				
7' 4 19/32"	77	77	77	77	77	77	73	68				
7' 2 5/8"	77	77	77	77	77	75	71	66				
7' 0 21/32"	77	77	77	77	77	73	68	64				
6' 10 11/16"	77	77	77	77	77	71	66	62				
6' 8 23/32"	77	77	77	75	68	64	60	60				
6' 6 3/4"	77	77	77	73	66	62	57	57				
6' 4 25/32"	77	77	77	71	64	60	57	57				
6' 2 13/16"	77	77	75	68	64	60	55	55				

Hawa Configurator













www.hawa.com/configurator

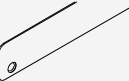

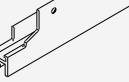
List of individual parts, which are included in the sets:



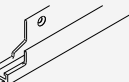



Set for 1 pivot /slide-in door up to 35 kg (77 lbs.)

	No.
Hawa Concepta III 35, basic set left, door height 1900–2700 mm (6' 2 13/16" to 8' 10 5/16")	30996
Hawa Concepta III 35, basic set right, door height 1900–2700 mm (6' 2 13/16" to 8' 10 5/16")	30997

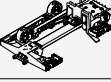

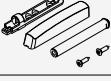
			No.
	30996	30997	
Set consisting of:			
	4	4	30686
	1	1	30738
	4	4	31070
	1	1	30811
	2	2	30983
	1	1	30986
	1		30805
	1		31059
	1	1	30810
	1	1	31047
		1	30806
		1	31060

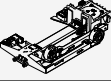
Suitable slide-in set

	No.
Hawa Concepta III 25/35, Push slide-in set, left	30998
Hawa Concepta III 25/35, Push slide-in set, right	30999

			No.
	30998	30999	
Set consisting of:			
	1		31038
	1	1	31043
	1	1	31010
	1	1	30838
	1		30818
		1	31039
		1	30827

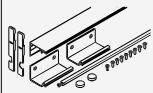
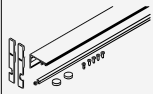
Cabinet connecting parts

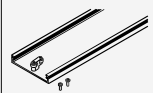
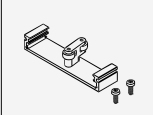
		mm (inch)	No.
	Connector set 55 mm (2 5/32"), for exterior connection to cabinet	560 (1' 10 1/16")	31005
	Connector top 55 mm (2 5/32"), for exterior connection to cabinet	560 (1' 10 1/16")	31430
	Connector top 110 mm (4 11/32"), for two pivot/slide-in doors	500 (1' 7 11/16")	31006
	Connector bottom 110 mm (4 11/32"), for two pivot/slide-in doors	500 (1' 7 11/16")	31246
	Connector bottom 110 mm (4 11/32"), for two pivot/slide-in doors (for installation in front of fixed plinth)	26 (1 1/32")	31007

Guides

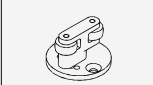
		No.
	Guide for two inset pivot sliding doors, aluminum	25680

Accessories

		No.
	Support for Halemeier automatic shut-off device Matching push button item 36 979 01 for Halemeier automatic shut-off device (Safety Box)	31020

Straightening fitting

→ Details under accessories frame page 265

Aluminum rew

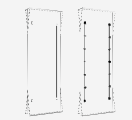
		Nr.
	Straightening fitting for doors 2040–2600 mm (6' 8 5/16" to 8' 6 3/8"), aluminum	056.3192.072
	Straightening fitting for doors 1715–2275 mm (3' 11 27/32" to 5' 9 7/8"), aluminum	056.3192.079

Aluminum anodized

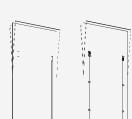
		No.
	Straightening fitting for doors 2240–2850 mm (7' 4 3/16" to 9' 4 7/32"), aluminum, anodized	056.3192.071
	Straightening fitting for doors 2040–2600 mm (6' 8 5/16" to 8' 6 3/8"), aluminum, anodized	056.3192.082
	Straightening fitting for doors 1715–2275 mm (5' 7 17/32" to 7' 5 9/16"), aluminum, anodized, can be shortened for doors 1215–1715 mm (3' 11 27/32" to 5' 7 17/32")	056.3192.080

Aluminum black anodized

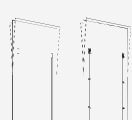
		No.
	Straightening fitting for doors 2240–2850 mm (7' 4 3/16" to 9' 4 7/32"), aluminum, black anodized	056.3192.074
	Straightening fitting for doors 2040–2600 mm (6' 8 5/16" to 8' 6 3/8"), aluminum, black anodized	056.3192.075
	Straightening fitting for doors 1715–2275 mm (5' 7 15/32" to 7' 5 9/16"), aluminum, black anodized	056.3192.081

Straightening fitting

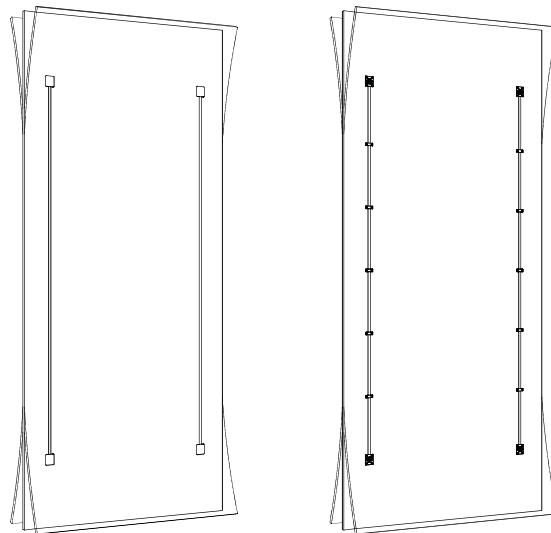

Further installation examples
Composed cabinet

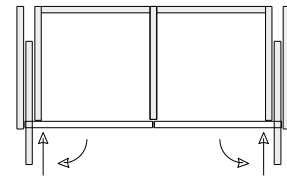
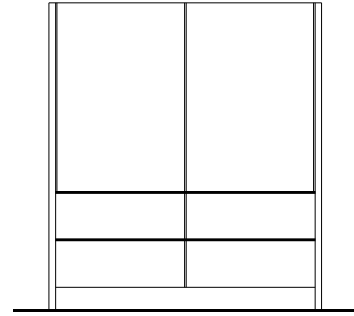
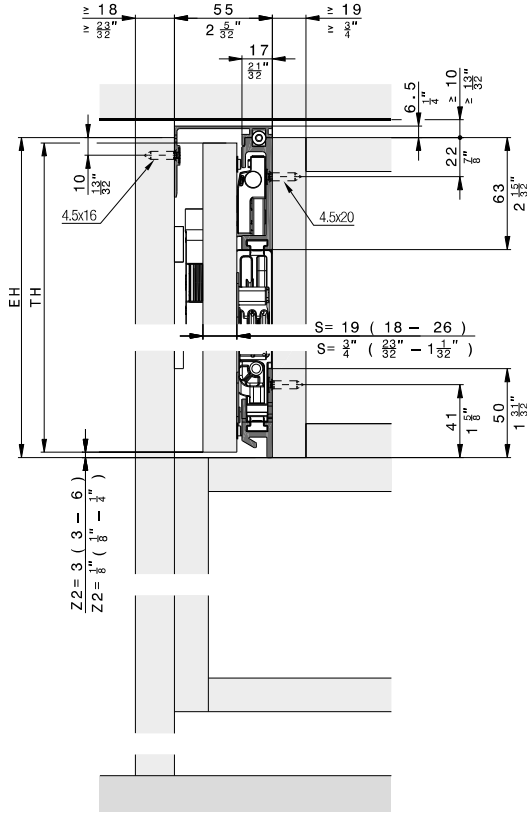

Cabinet without base panel

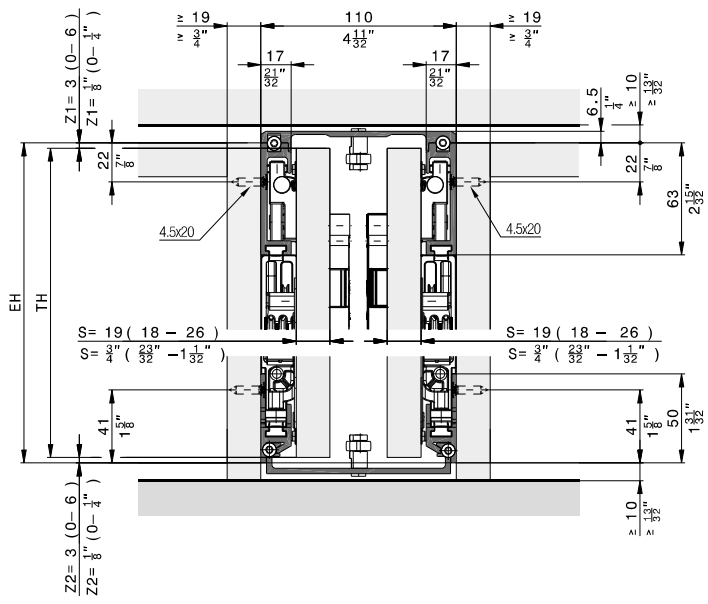
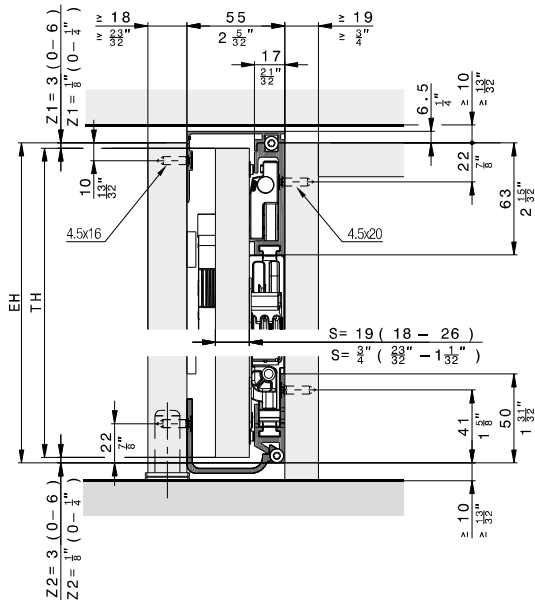

Inlaid doors

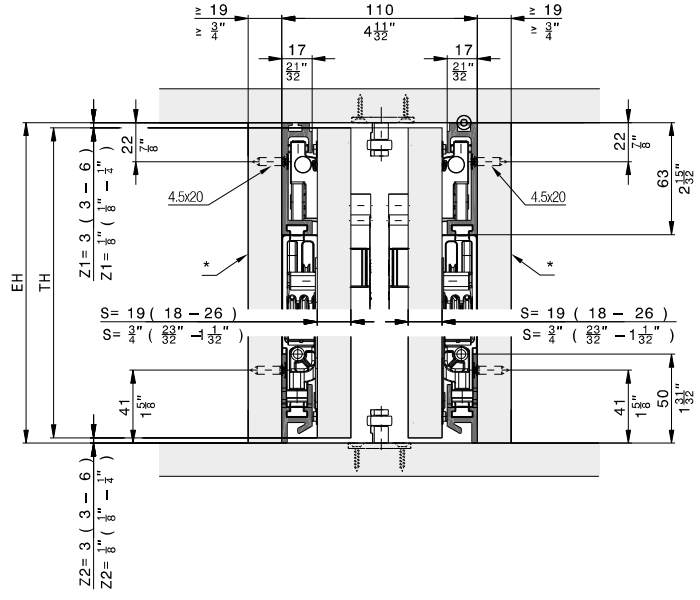
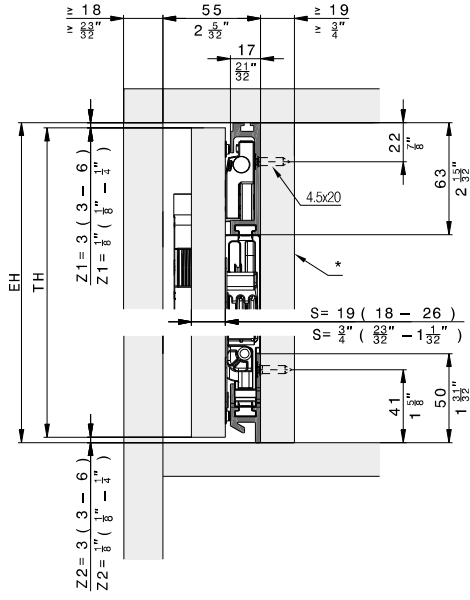

* removable

Floor-to-ceiling doors

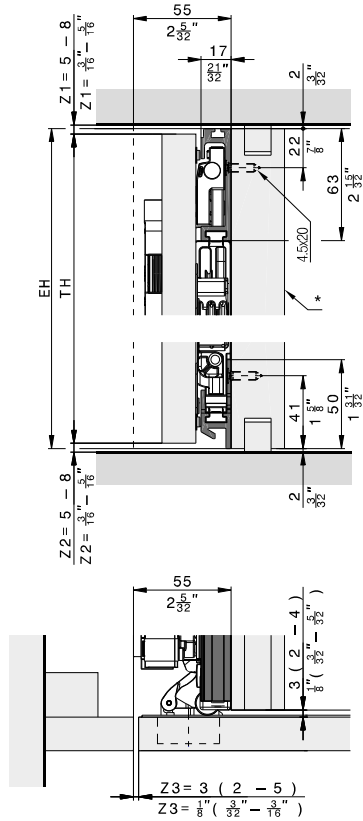

* removable

Hardware depth calculation

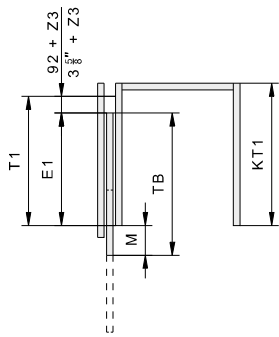

	mm	Inch
T1	≥ 414	≥ 1' 4 ⁵ / ₁₆ "

	mm	Inch
T1	TB + 92 + Z3 - M	TB + 3 ⁵ / ₈ " + Z3 - M
E1	TB - M	TB - M
M	≥ S + 3 ≤ TB - 320	≥ S + ⁵ / ₈ " ≤ TB - 1 ¹⁹ / ₃₂ "

Door flush with outer face

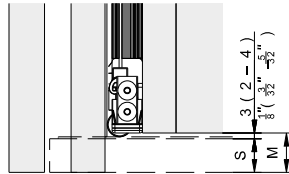

Protruding door

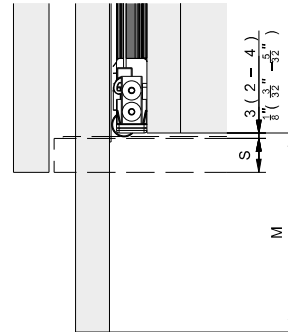

Instructions

[Installation](#) →

[Adjustment](#) →

[Connector](#) →

Videos

[Installation](#) →

[Adjustment](#) →

[Connector](#) →

Accessories

– Straightening fitting from page 265



Planning/execution

Configure with just a few clicks at www.hawa.com/configurator





Further information about the product can be found on www.hawa.com.

Hardware for pivoting and lateral sliding in of wooden doors up to 35 kg (77 lbs.). Uniform, flush front design with even gap pattern. Pull version with handle and integrated soft closing mechanism.

Product highlights

-  **Productivity** Easy installation thanks to high degree of pre-assembly with intuitive adjustment
-  **Comfort** Ergonomic movement support for even, smooth movement
-  **Aesthetics** Allows constructions with and without handle – the technology remains invisible

Technical specifications

-  10–35 kg (22 to 77 lbs.)
-  1900–2700 mm (6' 2 13/16" to 8' 10 5/16")
-  440–750 mm (1' 5 5/16" to 2' 5 17/32")
-  18–26 mm (23/32" to 1 1/32")

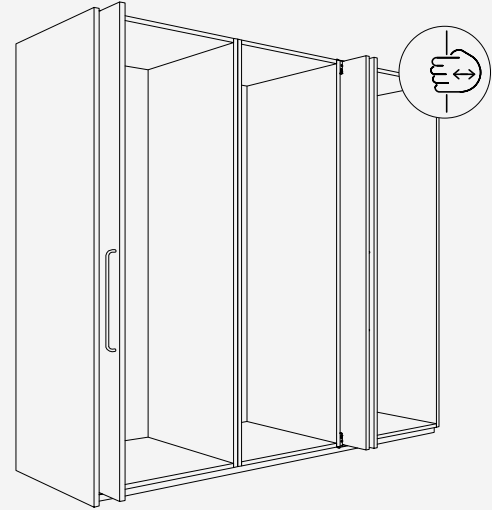

Installation examples

Door striking against the top and bottom cabinet sections

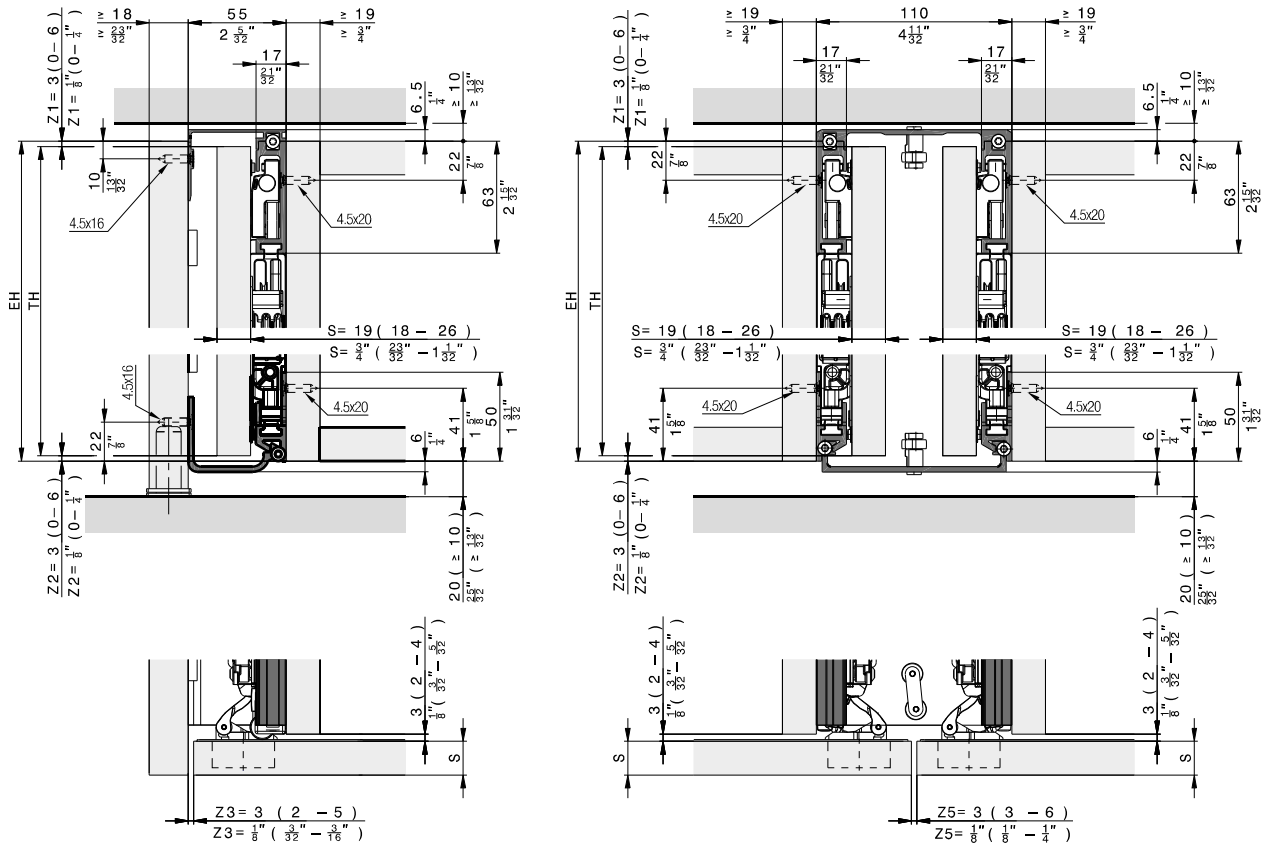

Components required for one cabinet

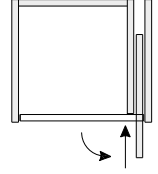
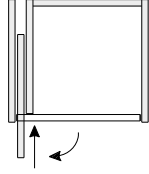

Hawa Concepta III 35 Pull, left

	No.
Hawa Concepta III 35, basic set left, door height 1900–2700 mm (6' 2 13/16" to 8' 10 5/16")	30996
Hawa Concepta III 25/35, Pull slide-in set, left	31000
Upright profile L= 2474 mm (8' 1 13/32"), for door height 1900–2700 mm (6' 2 13/16" to 8' 10 5/16"), aluminum, anodized	30771

Hawa Concepta III 35 Pull, right

	No.
Hawa Concepta III 35, basic set right, door height 1900–2700 mm (6' 2 13/16" to 8' 10 5/16")	30997
Hawa Concepta III 25/35, Pull slide-in set, right	31001
Upright profile L= 2474 mm (8' 1 13/32"), for door height 1900–2700 mm (6' 2 13/16" to 8' 10 5/16"), aluminum, anodized	30771

Weight and door size ratio calculations

The maximum weight must be adapted depending on the door size ratio.

		DE Türbreite / FR Largeur de porte / EN Door width / IT Larghezza anta / ES Ancho de puerta																			
		440	500	550	600	650	700	750													
DE Türhöhe / FR Hauteur de porte / EN Door height / IT Altezza anta / ES Altura de puerta	2700	35	35	35	35	35	35	35	DE Maximale Gewichte in kg / FR Poids maximale en kg / EN Maximum weights in kg / IT Pesì massimo in kg / ES Pesos máximos en kg	DE Türgewicht in lbs. / FR Poids de porte en lbs. / EN Door weight in lbs. / IT Peso anta in lbs. / ES Peso de puerta en lbs.	DE Türhöhe / FR Hauteur de porte / EN Door height / IT Altezza anta / ES Altura de puerta	1' 5 5/16"	77	77	77	77	77	77	77	DE Maximale Gewichte in lbs. / FR Poids maximale en lbs. / EN Maximum weights in lbs. / IT Pesì massimo in lbs. / ES Pesos máximos en lbs.	
	2650	35	35	35	35	35	35	35				1' 7 11/16"	77	77	77	77	77	77	77		
	2600	35	35	35	35	35	35	35				1' 9 21/32"	77	77	77	77	77	77	77		
	2550	35	35	35	35	35	35	35				1' 11 5/8"	77	77	77	77	77	77	77		
	2500	35	35	35	35	35	35	35				2' 1 19/32"	77	77	77	77	77	77	77		
	2450	35	35	35	35	35	35	34				2' 3 9/16"	77	77	77	77	77	77	77		
	2400	35	35	35	35	35	35	33				2' 5 17/32"	77	77	77	77	77	77	77		
	2350	35	35	35	35	35	34	32					77	77	77	77	75	71			
	2300	35	35	35	35	35	34	31					77	77	77	77	77	75	68		
	2250	35	35	35	35	35	33	31					77	77	77	77	77	73	68		
	2200	35	35	35	35	34	32	30					77	77	77	77	75	71	66		
	2150	35	35	35	35	33	31	29					77	77	77	77	73	68	64		
	2100	35	35	35	35	32	30	28					77	77	77	77	71	66	62		
	2050	35	35	35	34	31	29	27					77	77	77	77	71	66	62		
	2000	35	35	35	33	30	28	26					77	77	77	77	75	68	64		60
	1950	35	35	35	32	29	27	26					77	77	77	77	73	66	62		57
	1900	35	35	34	31	29	27	25					77	77	77	77	71	64	60		57
													77	77	75	68	64	60	55		

Hawa Configurator













www.hawa.com/configurator

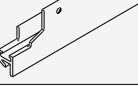

List of individual parts, which are included in the sets:







Set for 1 pivot /slide-in door up to 35 kg (77 lbs.)

	No.
Hawa Concepta III 35, basic set left, door height 1900–2700 mm (6' 2 13/16" to 8' 10 5/16")	30996
Hawa Concepta III 35, basic set right, door height 1900–2700 mm (6' 2 13/16" to 8' 10 5/16")	30997

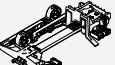

	30996	30997	No.
Set consisting of:			
	4	4	30686
	1	1	30738
	4	4	31070
	1	1	30811
	2	2	30983
	1	1	30986
	1		30805
	1		31059
	1	1	30810
	1	1	31047
		1	30806
		1	31060

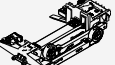
Suitable slide-in set

	No.
Hawa Concepta III 25/35, Pull slide-in set, left	31000
Hawa Concepta III 25/35, Pull slide-in set, right	31001

	31000	31001	No.
Set consisting of:			
	1		31040
	1	1	31414
	1	1	31221
	1		30964
		1	31041
		1	30965

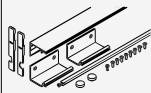
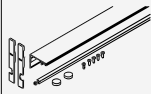
Cabinet connecting parts

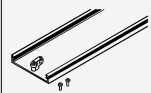
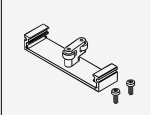
		mm (inch)	No.
	Connector set 55 mm (2 5/32"), for exterior connection to cabinet	560 (1' 10 1/16")	31005
	Connector top 55 mm (2 5/32"), for exterior connection to cabinet	560 (1' 10 1/16")	31430
	Connector top 110 mm (4 11/32"), for two pivot/slide-in doors	500 (1' 7 11/16")	31006
	Connector bottom 110 mm (4 11/32"), for two pivot/slide-in doors	500 (1' 7 11/16")	31246
	Connector bottom 110 mm (4 11/32"), for two pivot/slide-in doors (for installation in front of fixed plinth)	26 (1 1/32")	31007

Guides

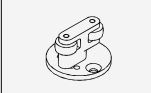
		No.
	Guide for two inset pivot sliding doors, aluminum	25680

Accessories

		No.
	Support for Halemeier automatic shut-off device Matching push button item 36 979 01 for Halemeier automatic shut-off device (Safety Box)	31020

Straightening fitting

→ Details under accessories frame page 265

Aluminum rew

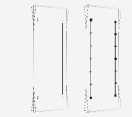
		Nr.
	Straightening fitting for doors 2040–2600 mm (6' 8 5/16" to 8' 6 3/8"), aluminum	056.3192.072
	Straightening fitting for doors 1715–2275 mm (3' 11 27/32" to 5' 9 7/8"), aluminum	056.3192.079

Aluminum anodized

		No.
	Straightening fitting for doors 2240–2850 mm (7' 4 3/16" to 9' 4 7/32"), aluminum, anodized	056.3192.071
	Straightening fitting for doors 2040–2600 mm (6' 8 5/16" to 8' 6 3/8"), aluminum, anodized	056.3192.082
	Straightening fitting for doors 1715–2275 mm (5' 7 17/32" to 7' 5 9/16"), aluminum, anodized, can be shortened for doors 1215–1715 mm (3' 11 27/32" to 5' 7 17/32")	056.3192.080

Aluminum black anodized

		No.
	Straightening fitting for doors 2240–2850 mm (7' 4 3/16" to 9' 4 7/32"), aluminum, black anodized	056.3192.074
	Straightening fitting for doors 2040–2600 mm (6' 8 5/16" to 8' 6 3/8"), aluminum, black anodized	056.3192.075
	Straightening fitting for doors 1715–2275 mm (5' 7 15/32" to 7' 5 9/16"), aluminum, black anodized	056.3192.081

Straightening fitting

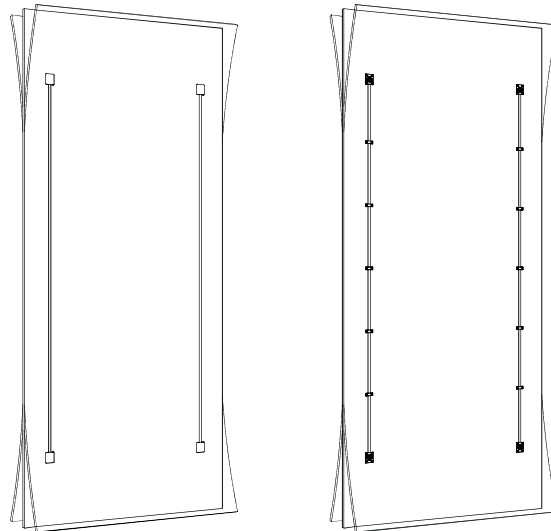

Further installation examples
Composed cabinet

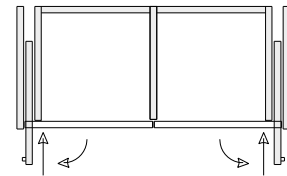
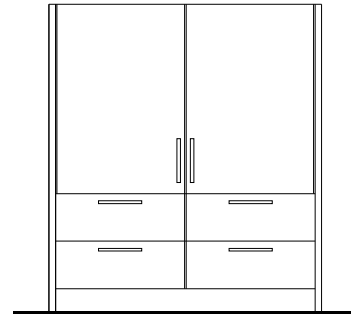
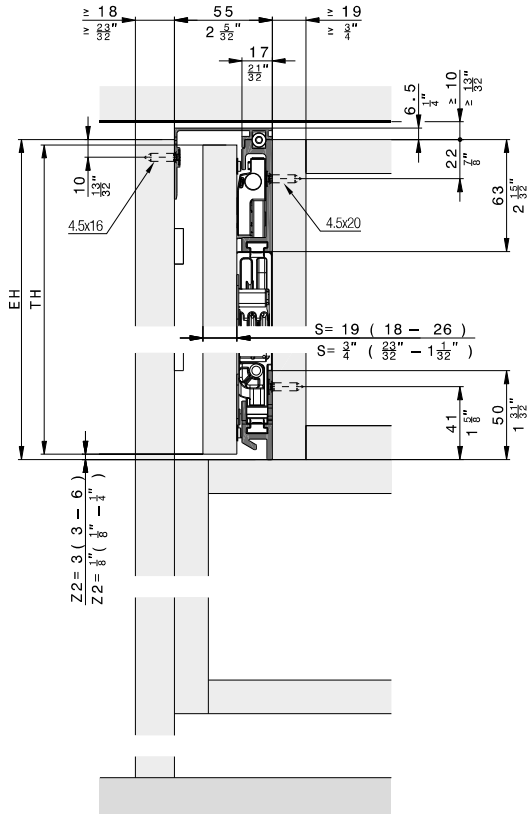

Cabinet without base panel

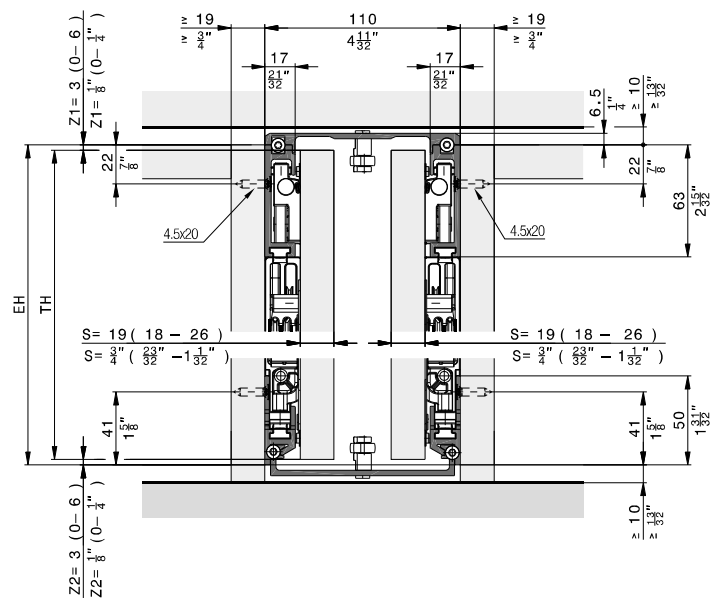
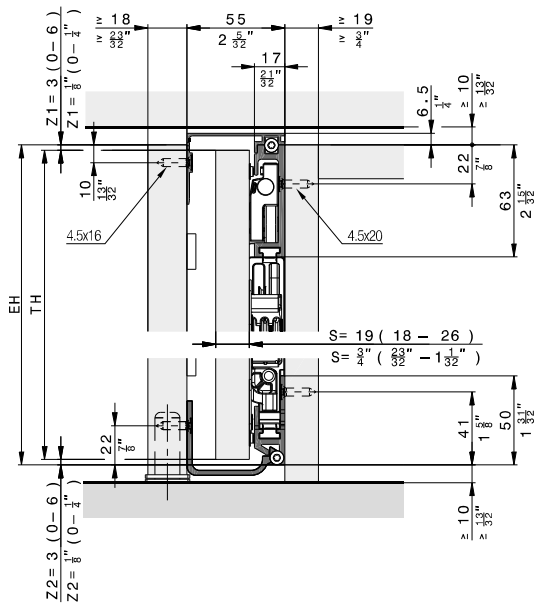

Inlaid doors

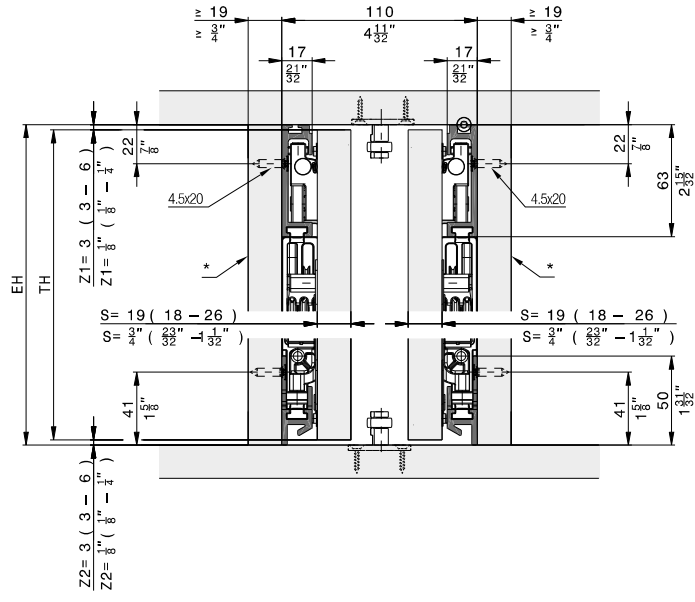
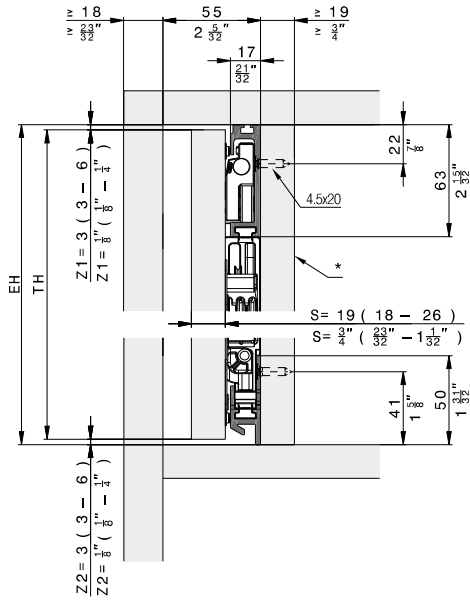

* removable

Floor-to-ceiling doors

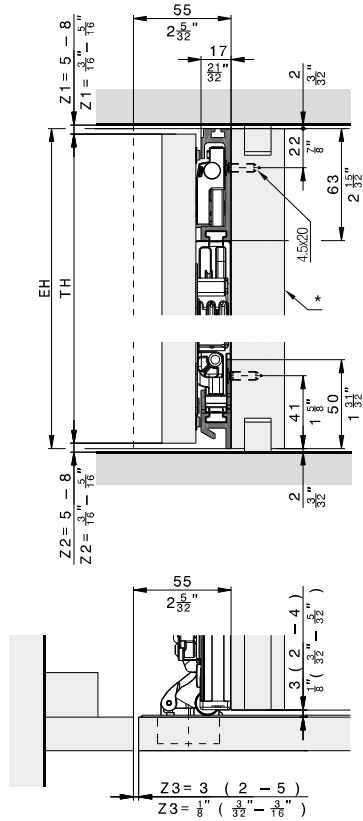

* removable

Hardware depth calculation

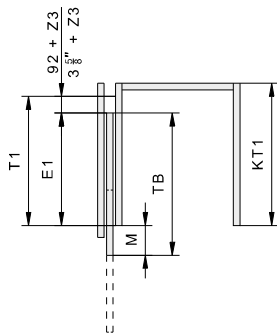

	mm	Inch
T1	≥ 414	≥ 1'4 ⁵ / ₁₆ "

	mm	Inch
T1	TB + 92 + Z3 - M	TB + 3 ⁵ / ₁₆ " + Z3 - M
E1	TB - M	TB - M
M	≥ S + 3 ≤ TB - 320	≥ S + ⁵ / ₈ " ≤ TB - 1 ¹⁹ / ₃₂ "

Door flush with outer face

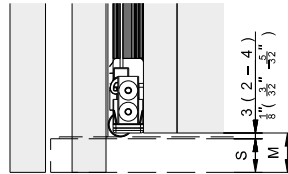

Protruding door

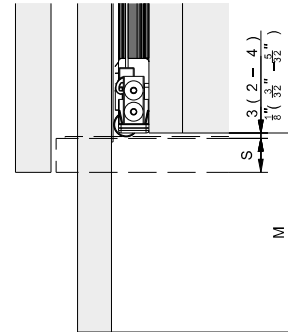

Instructions

Installation →

Adjustment →

Connector →

Videos

Installation →

Adjustment →

Connector →

Accessories

– Straightening fitting from page 265

Planning/execution

Configure with just a few clicks at www.hawa.com/configurator

Further information about the product can be found on www.hawa.com.