

**ISTRUZIONE MONTAGGIO CON ROSETTA VIS 50x7 TONDA E QUADRA (MONTAGGIO CON VITI LEGNO).
INSTALLATION SCHEME FOR VIS 50x7 ROUND AND SQUARE ROSE (WOOD SCREWS)**

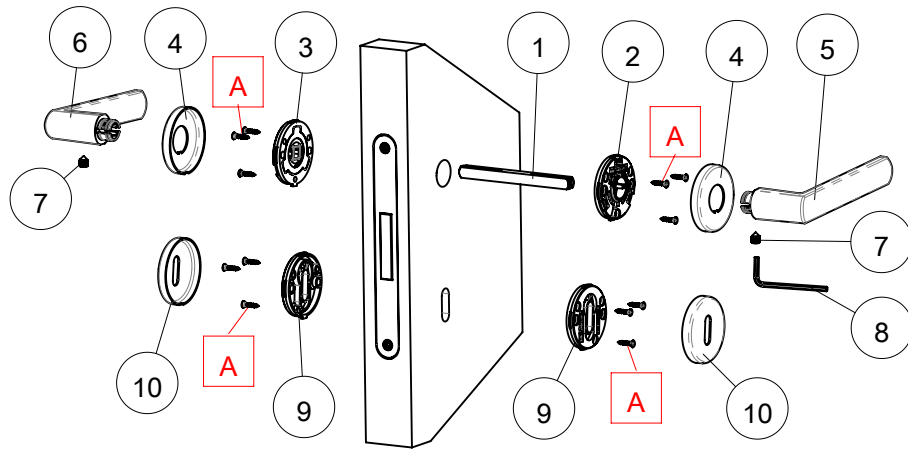

1	FERRO QUADRO	SQUARE SPINDLE
2	SOTTO ROSETTA CON MOLLA DESTRA	RIGHT HAND SPRING INNER ROSE
3	SOTTO ROSETTA CON MOLLA SINISTRA	LEFT HAND SPRING INNER ROSE
4	ROSETTA	ROSE COVER
5	IMPUGNATURA DESTRA	RIGHT HAND LEVER
6	IMPUGNATURA SINISTRA	LEFT HAND LEVER
7	VITE GRANO PER FISSAGGIO IMPUGNATURE	GRUB SCREW
8	CHIAVE ESAGONALE PER VITE GRANO	ALLEN KEY
9	SOTTO BOCCHETTA - PATENT / YALE	KEYHOLE/EURO CYLINDER PROFILE INNER NYLON BASE
10	BOCCHETTA PATENT / YALE	KEYHOLE /EURO CYLINDER PROFILE ESCUTCHEON COVER
A	VITI PER FISSAGGIO SOTTO ROSETTE/SOTTO BOCCHETTE	SCREW FIXINGS

SOTTO ROSETTA SINISTRA
LEFT HAND SPRING INNER ROSE

SC.01

SOTTO ROSETTA DESTRA
RIGHT HAND SPRING INNER ROSE

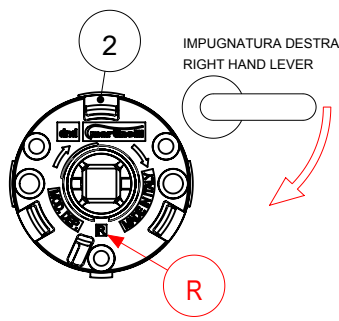
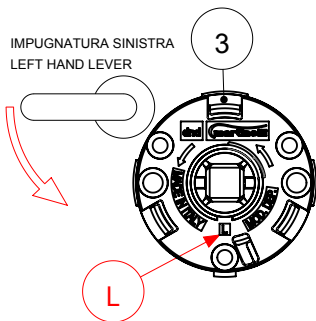

SC.02

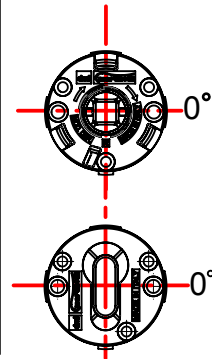

Fig.01: INSERIRE NELLA SERRATURA IL FERRO QUADRO (1) MANTENENDO LA SCANALATURA VERSO IL BASSO.
Fig.02: FARE ATTENZIONE A MANTENERE LA STESSA SPORGENZA DEL FERRO QUADRO (1) SU ENTRAMBI I LATI DEL BATTENTE.
Fig.03: RISPETTARE LA CORRETTA PERPENDICOLARITA' DEL FERRO QUADRO (1) RISPETTO AL PIANO DELLA PORTA.

Fig.01: PLACE THE SQUARE SPINDLE (1) THROUGH THE LOCK WITH THE GROOVE FACING DOWN.
Fig.02: PAY ATTENTION TO KEEP THE SAME PROJECTION OF THE SQUARE SPINDLE (1) ON BOTH SIDES OF THE DOOR LEAF.
Fig.03: KEEP THE CORRECT PERPENDICULARITY OF THE SQUARE SPINDLE (1) WITH RESPECT TO THE DOOR PLANE.

Fig.01

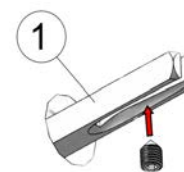

Fig.02

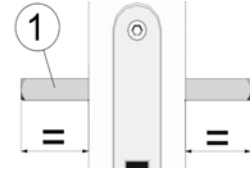
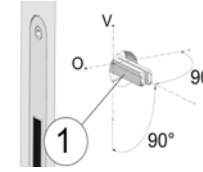

Fig.03



FISSARE LE SOTTO ROSETTE CON LE VITI FORNITE RISPETTANDO LO SCHEMA "SC.01" E "SC.02" E LA POSIZIONE INFERIORE DELLA TACCA DI POSIZIONAMENTO ROSETTA, APPLICARE LA ROSETTA.

FIX THE SPRING INNER ROSE BY USING THE PROVIDED SCREWS, FOLLOWING THE DIAGRAM "SC01" AND "SC02", AND THE LOWER POSITION OF THE INNER ROSES NOTCH. APPLY THE ROSE COVERS (4).



INSERTO DA ELIMINARE QUANDO
USATO CON BOCCHETTA FORO YALE

WHEN USING EURO CYLINDER PROFILE
ESCUTCHEONS, REMOVE THE CENTR OVAL
SECTION FROM THE NYLON INNER ROSE BASE

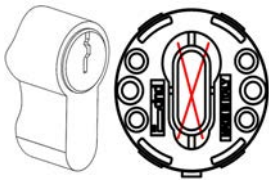

FISSARE LE SOTTO BOCCHETTE CON LE VITI FORNITE RISPETTANDO LO SCHEMA "SC.02" E LA POSIZIONE
DELLA TACCA INFERIORE ABBINAMENTO BOCCHETTA, APPLICARE LA BOCCHETTA

FIX THE KEYHOLE/EURO CYLINDER PROFILE NYLON INNER ROSE BASE BY USING THE PROVIDED SCREWS, FOLLOWING
THE DIAGRAM SC02, AND THE LOWER POSITION OF THE INNER NYLON ROSE NOTCH, APPLY THE ROSE COVERS (11) BY PRESSURE.



TACCA INFERIORE
NOTCH FACING DOWN



TACCA INFERIORE
NOTCH FACING DOWN

INSERIRE LE IMPUGNATURE (5 / 6) SUL FERRO QUADRO (1), FISSARE LA PRIMA IMPUGNATURA CON LA VITE GRANO (7), FISSARE LA SECONDA
IMPUGNATURA CON LA VITE GRANO (7) TENENDO ENTRAMBE LE IMPUGNATURE BENE IN APPOGGIO SULLE ROSETTE.

SLIDE BOTH LEVER HANDLES (5 / 6) ON THE SQUARE SPINDLE (1), FIX THE LEVER HANDLES BY KEEPING THEM FIRMLY AGAINST THE ROSES WHILE
TIGHTENING THE GRUB SCREW (7) WITH THE ALLEN KEY (8).

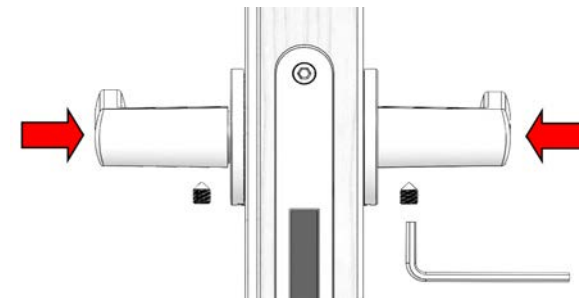

**ISTRUZIONE MONTAGGIO NOTTOLINO WC CON ROSETTA TONDA E QUADRA VIS 50x7 (MONTAGGIO CON VITI LEGNO)
 INSTALLATION SCHEME FOR VIS 50x7 ROUND AND SQUARE ROSE (WOOD SCREWS)**

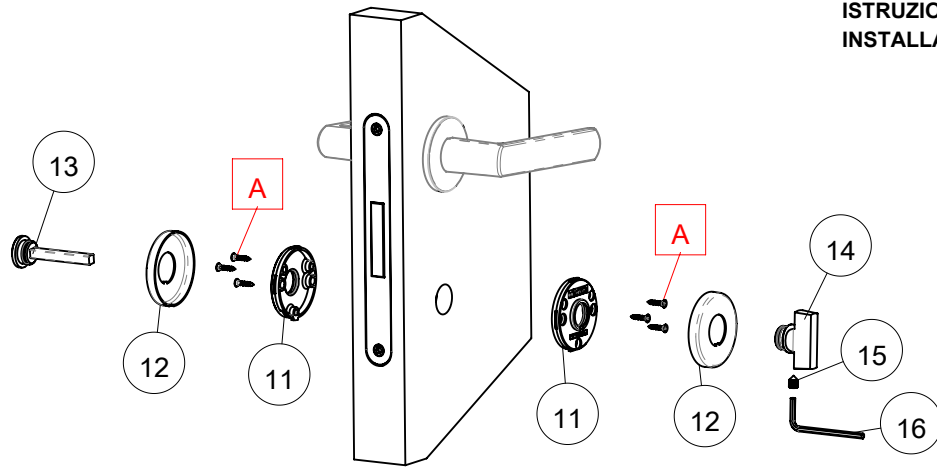

11	SOTTO ROSETTA SENZA MOLLA PER NOTTOLINO	INNER ROSE WITHOUT SPRING FOR TURN & RELEASE
12	ROSETTA	ROSE COVER
13	NOTTOLINO EMERGENZA ESTERNO	EMERGENCY RELEASE
14	NOTTOLINO GIREVOLE INTERNO	PRIVACY SNIB TURN
15	VITE GRANO PER FISSAGGIO NOTTOLINO INTERNO GIREVOLE	GRUB SCREW TO FIX THE PRIVACY SNIB TURN
16	CHIAVE ESAGONALE PER VITE GRANO	ALLEN KEY
A	VITI FISSAGGIO SOTTOROSETTE	SCREW FIXINGS

SC. 03

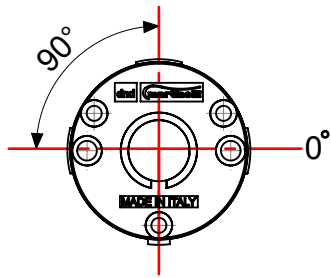

POSIZIONARE LE SOTTO ROSETTE (11) SULLA PORTA INSERIRE IL NOTTOLINO DI EMERGENZA ESTERNO (13) ED IL NOTTOLINO GIREVOLE INTERNO (14), IN MODO CHE LE SOTTO ROSETTE SIANO CENTRATE CON IL QUADRO DELLA SERRATURA.
 PLACE THE INNER ROSES (11) ON THE DOOR, INSERT THE EMERGENCY RELEASE (13) AND THE PRIVACY SNIB TURN (14) PAYING ATTENTION THAT THE INNER ROSES ARE CENTERED WITH THE SQUARE HOLE IN THE LOCK.

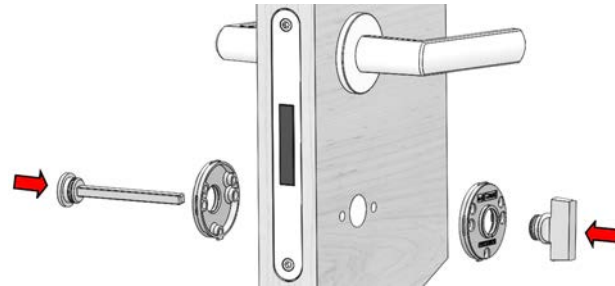

FISSARE LE SOTTO ROSETTE (11) CON LE VITI (A) FORNITE RISPETTANDO LO SCHEMA "SC.03" E LA POSIZIONE INFERIORE DELLA TACCA .
 FIX THE INNER ROSES (11) BY USING THE PROVIDED SCREW FIXINGS (A) FOLLOWING THE DIAGRAM "SC.03" AND THE LOWER POSITION OF THE INNER ROSE NOTCH.



TACCA INFERIORE
NOTCH FIXING DOWN

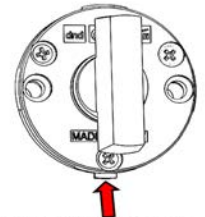

TACCA INFERIORE
NOTCH FIXING DOWN

ESTRARRRE IL NOTTOLINO GIREVOLE INTERNO (14) ED IL NOTTOLINO EMERGENZA ESTERNO (13).

REMOVE THE PRIVACY SNIB TURN (14) AND THE EMERGENCY RELEASE (13).

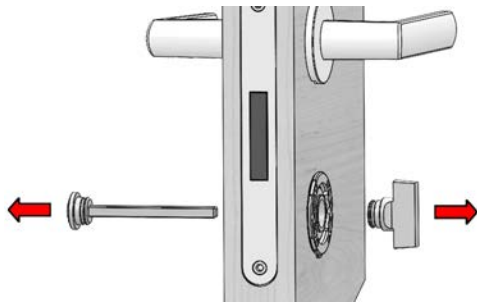

APPLICARE SULLE SOTTO ROSETTE (11) LE ROSETTE (12) RISPETTANDO LA POSIZIONE DELLA TACCA INFERIORE.

APPLY THE ROSE COVERS (12) ON THE INNER ROSES (11) PAYING ATTENTION TO THE LOWER POSITION OF THE NOTCH.

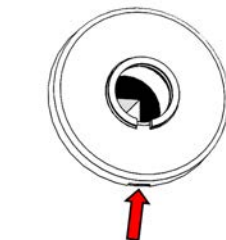

TACCA INFERIORE
NOTCH FIXING DOWN

INSERIRE IL NOTTOLINO DI EMERGENZA ESTERNO (13) E IL NOTTOLINO GIREVOLE INTERNO (14) NEL FORO DELLE ROSETTE (12).

INSERT THE EMERGENCY RELEASE (13) AND PRIVACY SNIB TURN (14), IN THE ROSES HOLE (12).

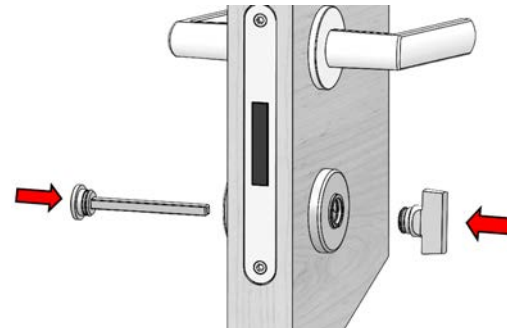

TENERE IN APPOGGIO SULLE ROSETTE E FISSARE CON LA VITE GRANO (15) UTILIZZANDO LA CHIAVE (16).

KEEP FIRMLY BOTH THE EMERGENCY RELEASE (13) AND PRIVACY SNIB TURN (14) AGAINST THE ROSES WHILE TIGHTENING THE GRUB SCREW (15) WITH THE ALLEN KEY (16).

