

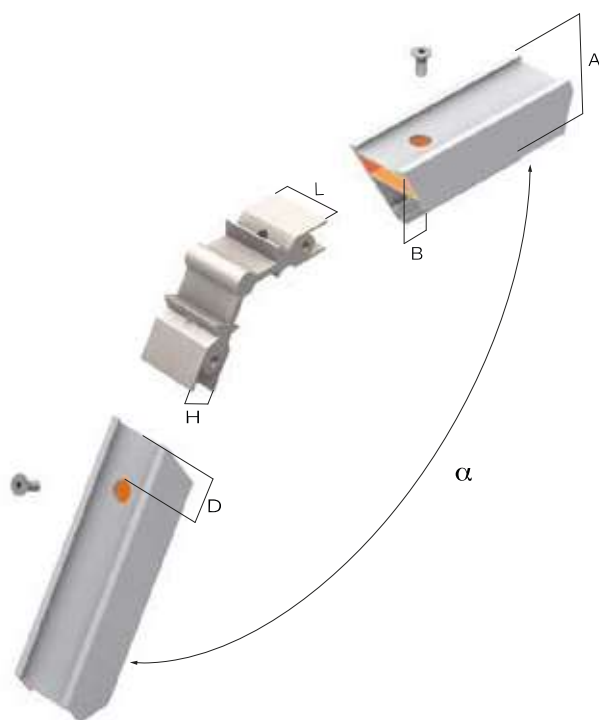





# 09 Squadrette ad angolo variabile in alluminio estruso



Codice	Articolo	L mm	H mm	$\alpha$	D mm	Pcs/pack	Kg/pack	€
12256505	1550	41	10,5	45°-315°	25+(7xB÷A)	50	3,2	4,331
12257005	1551	28,4	14	55°-315°	25+(7xB÷A)	50	2,7	4,040
12257505	1552	33,5	35,8	60°-330°	25+(7xB÷A)	20	1,8	10,565
12258005	1553	36	14	55°-315°	25+(7xB÷A)	50	3,5	5,691
12258505	1554	23,2	14	55°-315°	25+(7xB÷A)	50	2	4,121
12259005	1555	24	14	55°-315°	25+(7xB÷A)	50	2,4	4,236
12259505	1556 	36	10,4	45°-315°	25+(7xB÷A)	50	7,3	4,843
12260005	1557	28,4	34,5	60°-330°	25+(7xB÷A)	20	1,5	9,509
12260505	1558	28,4	14	55°-315°	25+(7xB÷A)	50	2,95	4,540
12261005	1559	22,8	35,5	60°-330°	25+(7xB÷A)	20	1,34	8,283
12261505	1560 	32	10,4	45°-270°	25+(7xB÷A)	50	3,1	3,479
12262005	1561 	32,8	14	55°-270°	25+(7xB÷A)	50	2,9	4,427
12262505	1562 	45,5	14	55°-270°	25+(7xB÷A)	50	3,2	4,566
12262510	1563 	40	26	60°-330°	25+(7xB÷A)	20	1,74	9,937
12260101	1564	27	31,5	60°-330°	25+(7xB÷A)	20	1,58	9,182
12260201	1565 	20,4	34,8	60°-330°	25+(7xB÷A)	20	1,22	9,182
12260301	1566	21,5	10,5	55°-315°	25+(7xB÷A)	50	2	4,307
12260401	1567	21,8	14	55°-315°	25+(7xB÷A)	50	2	4,119
12260402	1568	21,8	35,8	60°-330°	25+(7xB÷A)	20	1,3	9,148

Finitura: Burattatura e sabbatura