

SUPPORTI E CUSCINETTI PER RIDUTTORI

SUPPORTS AND BALL BEARINGS FOR REDUCTION PULLEY

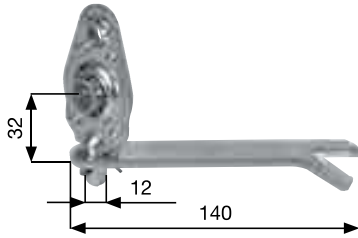

125.S.00.20

SUPPORTO A MURO per riduttore
Wall fixing support for reduction pulley

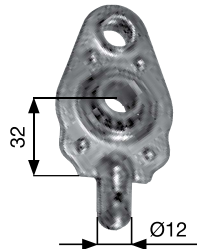

TESTINA A SFERE per riduttore
Ball-bearing for reduction pulley

125.T.00.20

boccola (6+10) / bush (6+10)

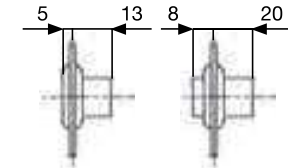
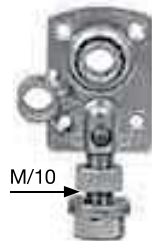

TESTINA A SFERE "TN" REGISTRABILE per riduttore
Adjustable ball-bearing "TN" for reduction pulley

125.T.RF.20

boccola (5+13) / bush (5+13)

125.T.RS.20

boccola (8+20) / bush (8+20)

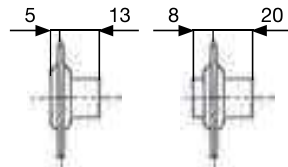
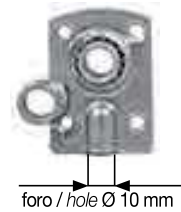

TESTINA A SFERE "TN" ESTRAIBILE per riduttore
removable ball-bearing "TN" for reduction pulley

125.T.TR.20

boccola (5+13) / bush (5+13)

125.T.TS.20

boccola (8+20) / bush (8+20)

SUPPORTI A MURARE – CUSCINETTI A SFERE

WALL SUPPORTS – BALL BEARINGS

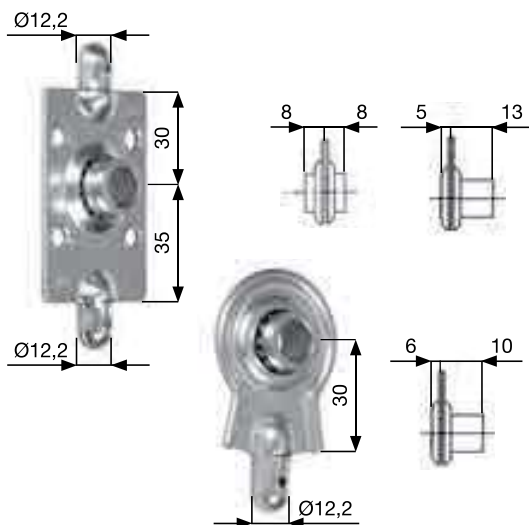

TESTINA A SFERE "DUAL"

Doppia scelta altezza: 30 o 35 mm

BALL BEARING "DUAL" – double size: 30 or 35 mm

128.T.DS.20

boccola 16 mm (8+8)-foro Ø 12,4 mm
bush 16 mm (8+8)- hole Ø 12,4 mm

128.T.DU.20

boccola 18 mm (5+13)-foro Ø 12,4 mm
bush 18 mm (5+13)- hole Ø 12,4 mm

TESTINA A SFERE "TE-EZ" – h : 30 mm

BALL BEARING "TE-EZ" – h : 30 mm

128.T.30.20

boccola 16 mm (6+10)-foro Ø 12,4 mm
bush 16 mm (6+10) - hole Ø 12,4 mm