



CARATTERISTICHE

Tradizionale ma ancora utilizzato da molti falegnami:

semplice
robusto
affidabile

ISTRUZIONI PER IL MONTAGGIO

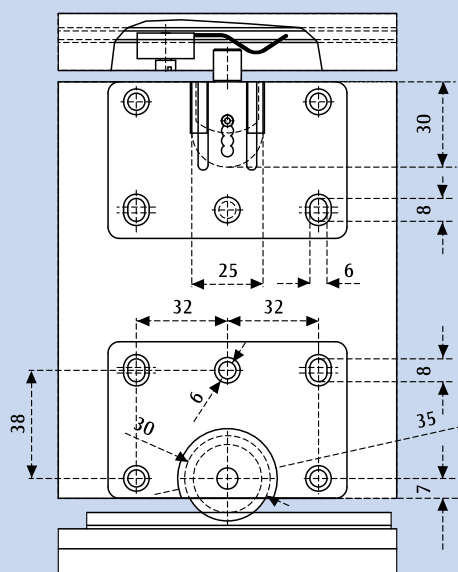

A

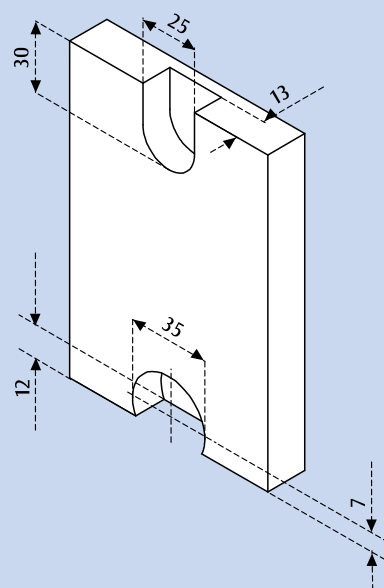

B

Kit DORADO

CODICE
1004003

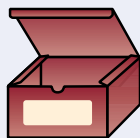

2 carrelli inferiori

2 carrelli superiori

2 fermi fine corsa

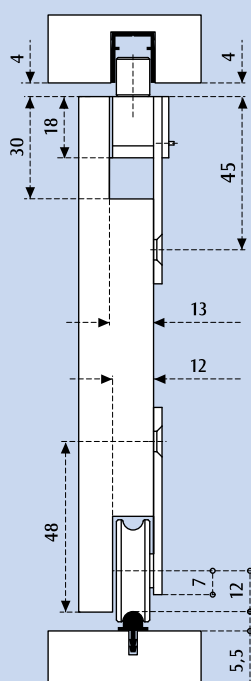

C

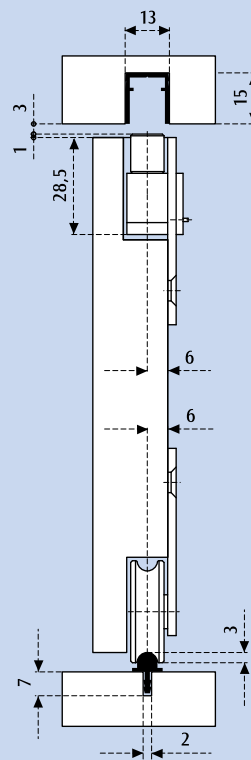

D

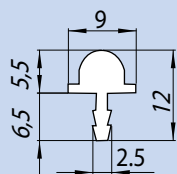

Profilo in alluminio ossidato

ARGENTO	CODICE 1004001A
BRONZO	CODICE 1004001B
NERO	CODICE 1004001N

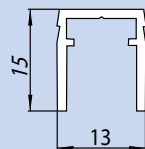

Profilo in alluminio ossidato, fori svasati ogni 30 cm, vite TSP Ø 2,5

ARGENTO	CODICE 1004002A
BRONZO	CODICE 1004002B
NERO	CODICE 1004002N

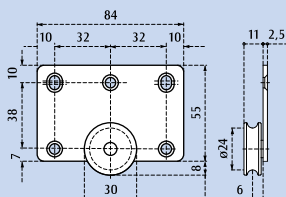
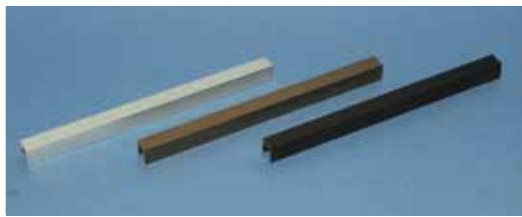

Carrello inferiore

CODICE 1004004

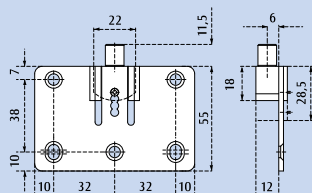

Carrello superiore con regolazione

CODICE 1004005

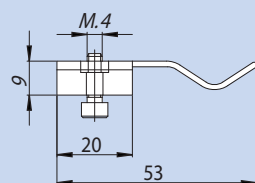

Fermo fine corsa

CODICE 1004008

