

Life made easy

Bullet PICCOLO

PATENT PENDING

CGS-600.18 P

Carrello Bullet Piccolo regolabile a 18 ruote

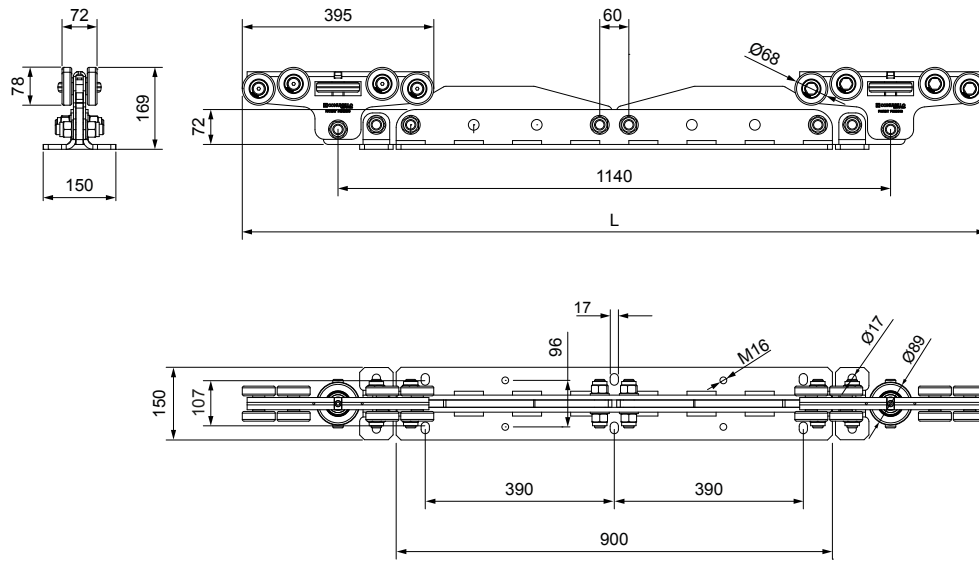
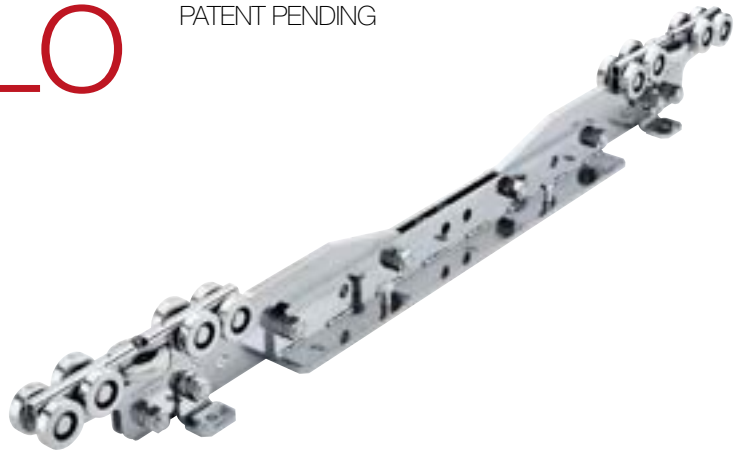

CODE	ART.	Size	L position A	L position B	L position C	Box info	
						Pcs per pack	Kg
10130405 001	CGS-600.18 P	Piccolo	1535	1795	2055	1	54.5

Dimensioni minime getto cemento armato

CALCOLO FONDAZIONE

Weight (Kg)	POSITION A		POSITION B			POSITION C		
	L=2 m FA (m)	L=3 m FA (m)	L=4 m FA (m)	L=5 m FA (m)	L=6 m FA (m)	L=7 m FA (m)	L=8 m FA (m)	
100	1.3	1.3	1.3	1.3	1.3	1.3	1.3	
150	1.3	1.3	1.3	1.3	1.3	1.3	1.3	
200	1.3	1.3	1.3	1.3	1.3	1.3	1.5	
250	1.3	1.3	1.3	1.3	1.3	1.5	1.6	
300	1.3	1.3	1.3	1.3	1.5	1.6	1.8	
350	1.3	1.3	1.3	1.4	1.6	1.8	2.0	
400	1.3	1.3	1.4	1.6	1.7	1.9		
450	1.3	1.3	1.5	1.7	1.9			
500	1.3	1.4	1.6	1.8				
550	1.3	1.5	1.7	2.0				
600	1.3	1.6	1.8					
650	1.4	1.7	2.0					
700	1.5	1.8	2.1					
750	1.6	1.9						
800	1.7	2.0						
850	1.8							
900	1.9							
950	2.0							
1000	2.1							
1050	2.3							

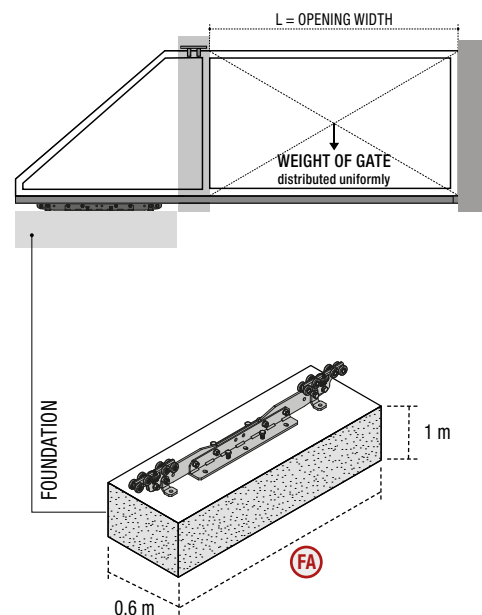

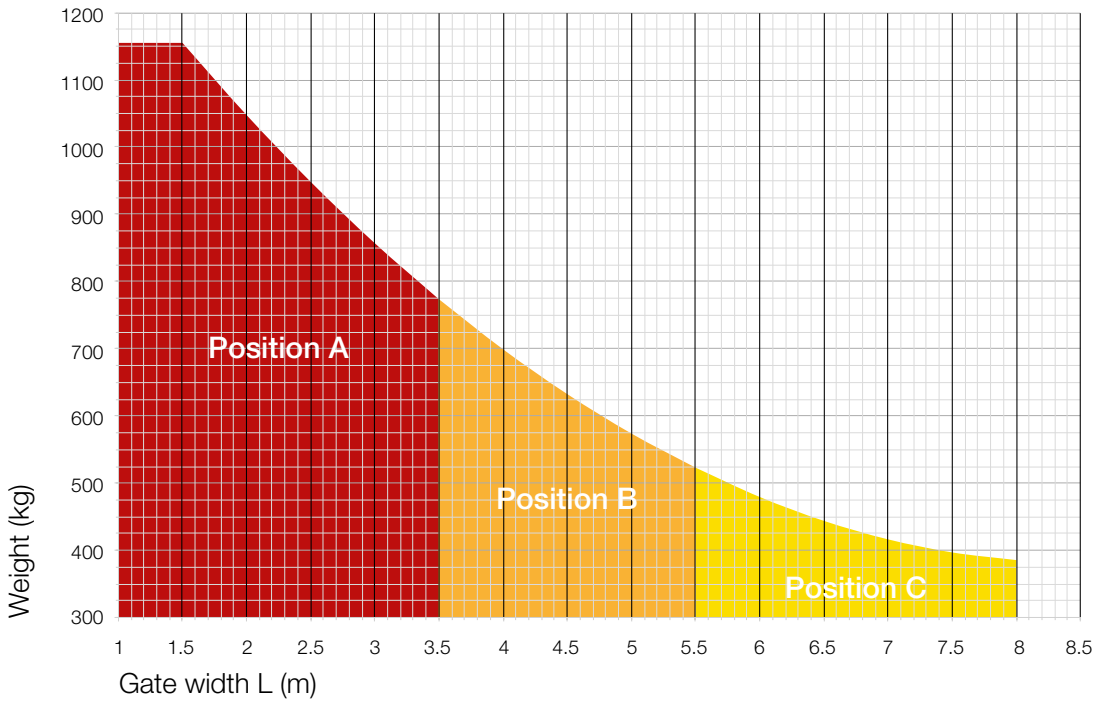

Bullet PICCOLO - Position A

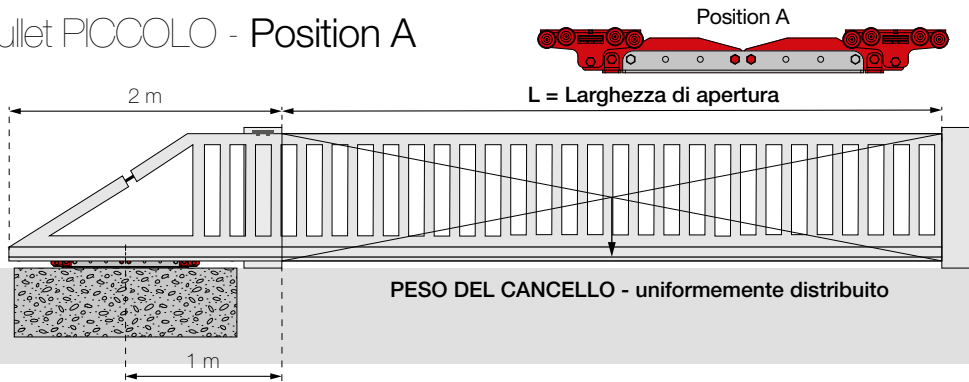

Bullet PICCOLO - Position B

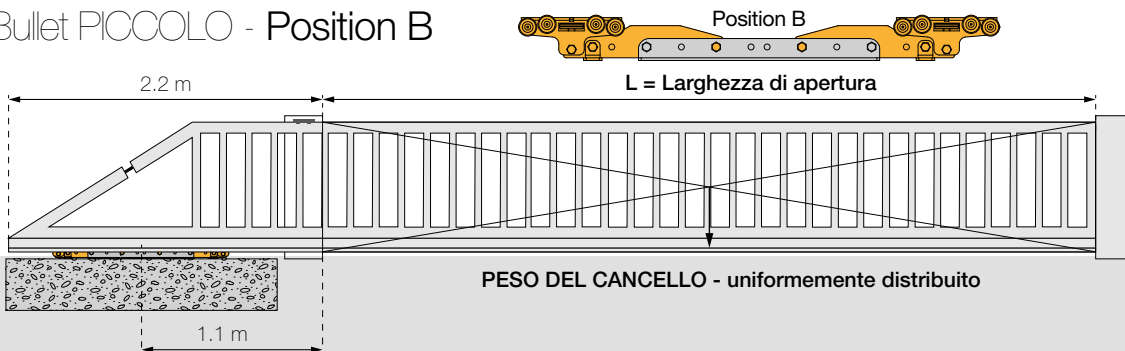

Bullet PICCOLO - Position C

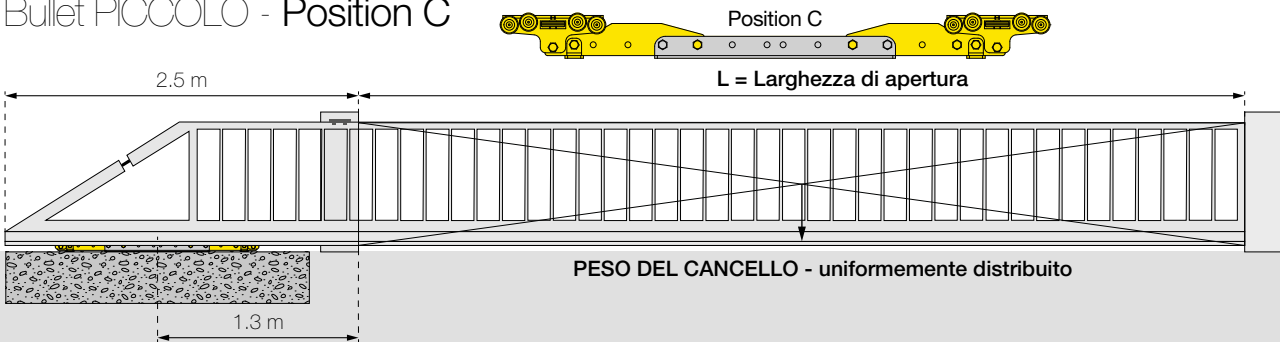

L'automazione deve essere installata in corrispondenza dell'asse centrale del carrello