

Serie PK

PROFILI A CREMAGLIERA
Per pannelli da 10 mm a filo
oppure con cover di finitura

PK Series

SLOTTED PROFILES
For 10 mm panel thickness
or to use with finishing cover



Montaggio a pressione dei pannelli con tasselli in plastica avvitati sul retro

Pres fit panel mounting with plastic clamps screwed on the back

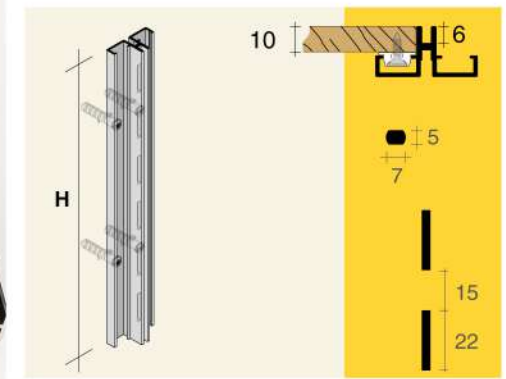

Codici Codes	Al	H	
PK1.2013.		2013	 PK1 singola single
PK1.2531.		2531	
PK1.3012.		3012	
			 PK2 doppia double
PK2.2013.		2013	
PK2.2531.		2531	
PK2.3012.		3012	
			 PK7 singola laterale reversibile lateral single reversible
PK7.2013.		2013	
PK7.2531.		2531	
PK7.3012.		3012	

Guarnizione, Ø 4 mm
Gasket, Ø 4 mm

GRN.10MT.ARG Grigio Gray

GRN.10MT.NER Nero Black

GRN.10MT.BGE Bronzo Bronze

Fermapannelli in policarbonato
per pannelli da 6 mm (a filo)

Polycarbonate **panel hooks**
for 6 mm (flush) panels

DX CN SX

FPN.06DX.TRA

FPN.06CN.TRA

FPN.06SX.TRA

Spessore massimo
consigliato per l'uso
della maggior parte
degli accessori

Maximum panel
thickness
recommended to
exploit the most of
accessories

Viti per pannelli
da 10 mm

Screws for
10 mm panels

PKA.V100.ZIN

Tassello per il montaggio dei pannelli
Clamp for panel mounting

38,5

1 1/2

14

50

PKA.FPK1.TRA ~ 40 kg

Tenuta a strappo
Tearing resistance

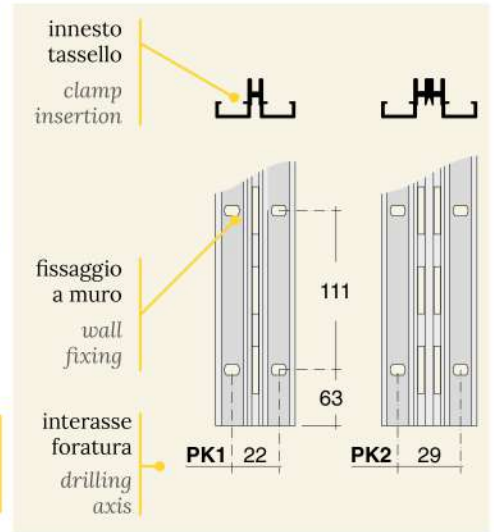

Dime per il posizionamento dei tasselli sul retro dei pannelli
Templates for clamp placement on the back of the panel

PKA.DIMA.NAT

Finiture Finishings	Alluminio Aluminium	Al		Al
Argento satinato Satinized Silver	NAT	Brillante Brilliant	LUX	
Nero Black	ANE	Finitura inox Inox finishing	NOX*	
Dorato satinato Satinized gold	ORO	Dorato lucido Polished gold	DOL*	
Superficie simil-acciaio inox Satinized Silver	SSO*			

Serie PK

COVER DI FINITURA
Per pannelli da 10 mm a filo
oppure con cover di finitura

PK Series

FINISHING COVERS
For 10 mm panel thickness
or to use with finishing cover

Montaggio a pressione dei pannelli con tasselli in plastica avvitati sul retro

Pres fit panel mounting with plastic clamps screwed on the back

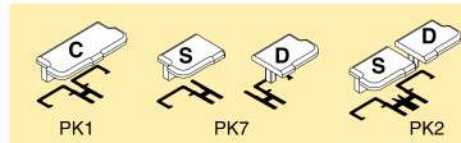

Cremagliere
Slotted profiles

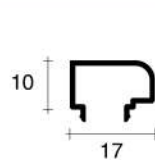

Codici Codes	Al	H
CPK.2013. ___	2013	2013
CPK.2531. ___	2531	2531
CPK.3012. ___	3012	3012

CPK
stondato
rounded



Profili PK con
coperture CPK
PK profiles with
coverings CPK

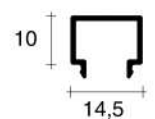

CSK.2013. ___	2013	2013
CSK.2531. ___	2531	2531
CSK.3012. ___	3012	3012

CSK
quadrato
squared



Profili PK con
coperture CSK
PK profiles with
coverings CSK

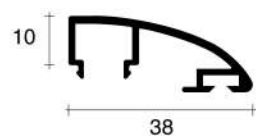

CLK.2013. ___	2013	2013
CLK.2531. ___	2531	2531
CLK.3012. ___	3012	3012

CLK
ellittico
elliptical

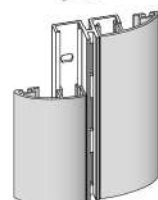

Profili PK con
coperture CLK
PK profiles with
coverings CLK

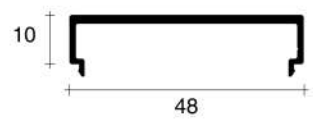

SCK.2013. ___	2013	2013
SCK.2531. ___	2531	2531
SCK.3012. ___	3012	3012

SCK
distanziale
spacer

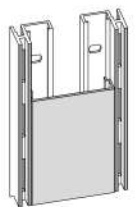

Tappi di finitura Finishing end caps

PKT.CPKC. ___
PKT.CPKD. ___
PKT.CPKS. ___

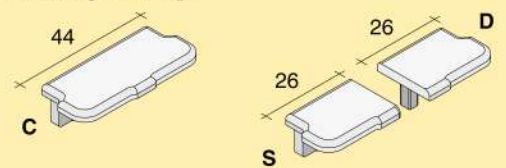

PKT.CSKC. ___
PKT.CSKD. ___
PKT.CSKS. ___

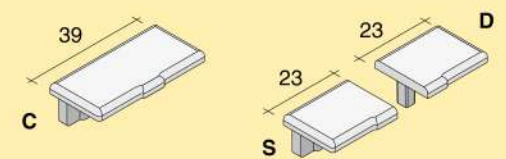

PKT.CLK1. ___
PKT.CLK2. ___

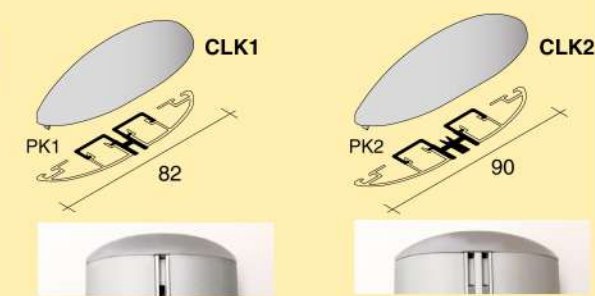

Finiture Finishings	Alluminio Aluminium	Al	Al	Al
Argento satinato Satinized Silver	NAT	Brillante Brilliant	LUX	Lucido Brillante Bright
Nero Black	ANE	Finitura inox Inox finishing	NOX*	SLX*
Dorato satinato Satinized gold	ORO	Dorato lucido Polished gold	DOL*	

Finiture Finishings	Acciaio Steel	Fe	Fe
Cromato lucido Polished Chrome	CHL	Dorato satinato Satinized gold	NKL
Nichel argento satinato Satined silver-Nickel	NKS	Nichelato opaco Matt nickel-plated	NKO*
Nero Black	NER		

codice code
XXX.XXXX.XXX* Asterisco = la finitura potrebbe non essere in pronta consegna.
Asterisk = finishing not always ready in stock.

Finiture disponibili per profili H = 3012 mm
Finishing available for profiles H = 3012 mm

Quote espresse in millimetri.
Dimensions are in millimeters.

Accessori correlati
Related accessories



Serie PK - profilo R19

PROFILO DI RIVA per profili a cremagliera
serie PK e CG

PK Series - R19 profile

EDGE PROFILE for PK and CG series

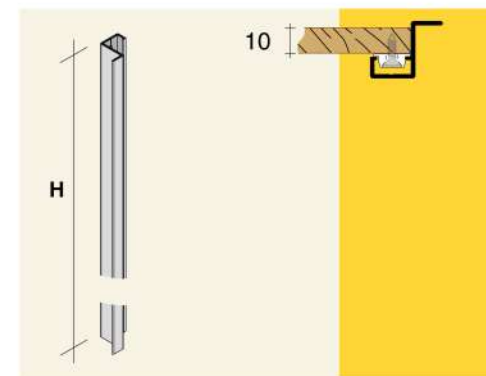

Montaggio a pressione dei pannelli con tasselli in plastica avvitati sul retro

Pres fit panel mounting with plastic clamps screwed on the back



Codici Codes	AI	H
R19.3000.NAT		3012

Utilizzo in verticale

Vertical use

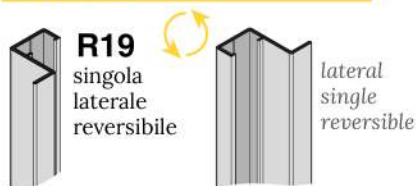

PANNELLO spessore
10 mm
PANEL 10 mm
thick

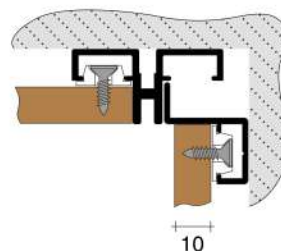

Utilizzo in orizzontale

Horizontal use

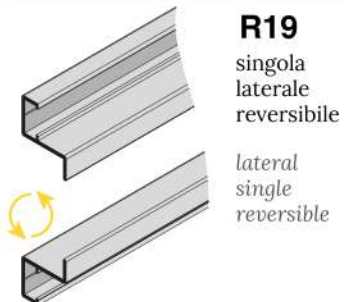

PANNELLO spessore
10 mm
PANEL THICKNESS
10 mm

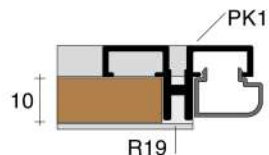

PANNELLO spessore
18 mm
PANEL THICKNESS
18 mm

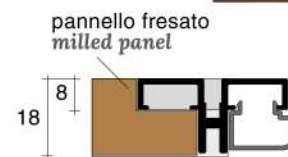

ESEMPIO LASTRA
spessore 5 mm
EXAMPLE SLAB
THICKNESS 5 mm

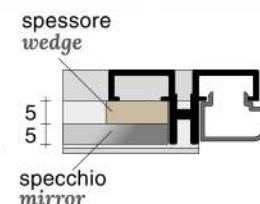

R19

PK1

Fissaggio a muro di
PK e R19
Fixing to the wall
of PK and R19



CPK

Montaggio dei profili di
copertura con taglio a 45°
Mounting of the cover
profiles cut at 45°

Compatibile con tutti i profili della serie PK e con le 3 coperture CPK, CSK, CLK.

Compatible with all PK series and with 3 kind of covers CPK, CSK, CLK.



CPK + R19 + PK1

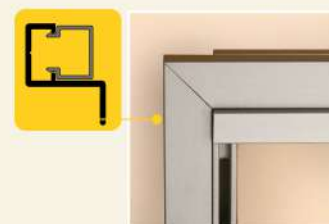

CSK + R19 + PK7



CLK + R19 + PK2

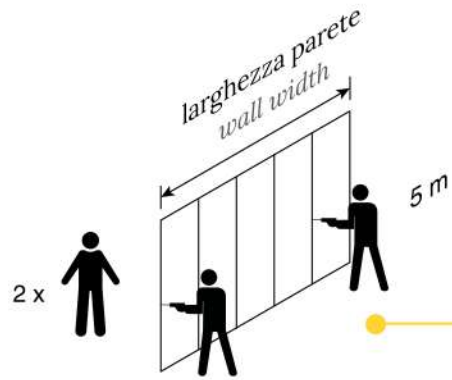

Sistema NB NB System	
Cremagliere NB Nb Slotted profiles	Rivestimento NB0 NB0 wall cladding
1 h 30'	2 h 30'

PK
6 h

CG
8 h

CR
6 h

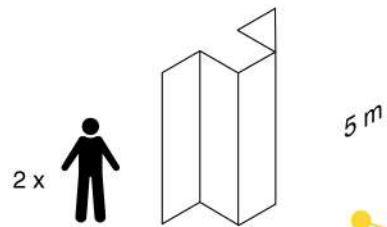

Angolo con NB9 Angle with NB9	Rivestimento NB0 NB0 wall cladding
3 h	5 h

PK-R19
-

-

Angolo con CR0 Angle with CR0
8 h

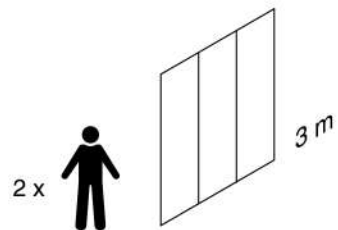

Cremagliere NB Nb Slotted profiles	Rivestimento NB0 NB0 wall cladding
1 h	2 h

4 h

5 h

4 h

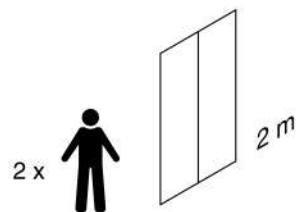

Cremagliere NB Nb Slotted profiles	Rivestimento NB0 NB0 wall cladding
45 min	1 h 30'

3 h

4 h

3 h 30'

Note tecniche

Technical data

CAPACITÀ DI CARICO

LOADING CAPACITY

Durante l'utilizzo di profili porta-piani in alluminio **si tengano presenti i seguenti fattori:**

- **STRATEGIA DI PRODUZIONE:** la progettazione di ogni profilo, la scelta della lega e le fasi di produzione sono integrate per ottenere da ciascuno di essi la qualità e la tenuta stabilite. La mancanza di questo accorgimento è la ragione per cui le riproduzioni dei nostri prodotti non hanno le necessarie caratteristiche di portata.
- **FISSAGGIO:** i profili sono realizzati per superare la tenuta del tassello a muro (mediamente 350 kg in condizioni ottimali), quindi è fondamentale che l'ancoraggio a parete sia opportunamente eseguito, anche per mezzo di telai quando necessario.
- **PROGETTAZIONE DELLE AMBIENTAZIONI:** le indicazioni di questo catalogo e la professionalità dell'installatore o del progettista, determinano la selezione del giusto profilo e della sua applicazione, secondo le finalità. Sono disponibili svariate opzioni: tipo di foratura - singola o doppia - e montaggio, asse centrale o laterale, distanze ed interassi ed i loro conseguenti accessori.

Keep in mind these factors during the use of aluminium profiles:

- **PRODUCTION STRATEGY:** The design of the different profile sections are decided in relation with the alloy choice and the manufacturing processes. It allows each item to reach the reference loading capacity. This is the main reason why replicated products, found sometimes in the market, do not reach the FitArt loading capacity characteristics.
- **FIXING:** Profiles are conceived in order to exceed the loading capacity of a 5 mm wall plug that reaches in average around 350 kg under normal operating conditions. It is very important to carry out the most suitable fixing to the wall, also using frames if necessary.
- **PLANNING AND DESIGN OF THE STRUCTURE:** The indications of this catalogue and the professional experience of a designer or an installer determine the choice of a right profile and its application. The different profiles options are available regarding: drilling types -single or double- and assembly, central or side load, distances and spans between profiles, and its related accessories.

PROVE DI CARICO

LOADING TESTS

I nostri profili a cremagliera sono sottoposti a severe **prove distruttive con simulazioni in laboratorio.**

Le immagini e il grafico qui riprodotti mostrano un nostro profilo standard, caricato su un singolo dente, resistere fin oltre 400 kg.

Our slotted profiles are subjected to very severe **destructive tests in laboratory simulations.**

The test here described shows a standard profile, with support loaded on a single tooth, standing over 400 kg.

Compressione cremagliera murale NB1

NB1 Wall slotted profile compression

TABELLA
DI DEFAULT
DEFAULT
TABLE

Modo di controllo 1
Velocità 1
Corsa 1
5 mm/min

Control 1
Speed 1
Run 1
5 mm/min

Risultati
Results

	Etichetta provino Label test	Carico compressione Compression load
1	T.01	> 438,819 [daN]

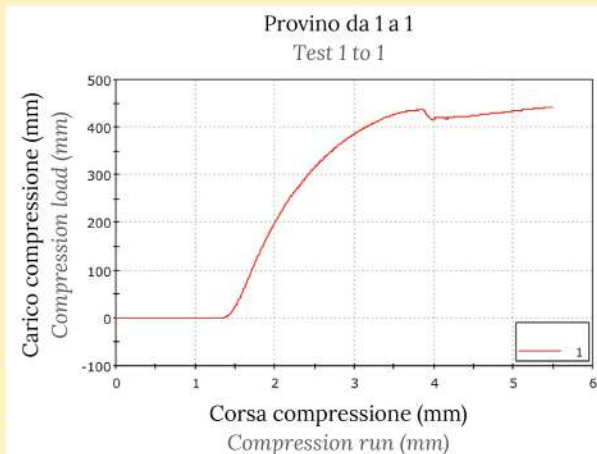

Sezione
cremagliera
Profile
section

Supporto
caricato
Support
loaded

Provino
Test

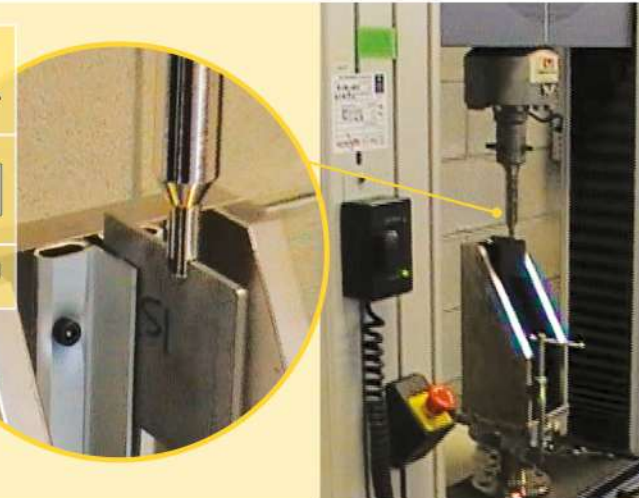
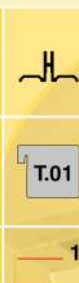

Decliniamo ogni responsabilità per l'utilizzo dei nostri profili con supporti non di nostra produzione, e viceversa, in particolare se prodotti in acciaio inossidabile.

Fit Art disclaims any responsibility for the use of our profiles with supports not of our production, and vice versa, especially the ones realized in stainless steel.



SOLLECITAZIONI AL CARICO

LOADING REACTION

Un carico puntuale su un profilo a cremagliera produce gli stessi effetti di una leva di primo genere (palanchino): **aumentando la distanza dal fulcro (braccio della leva) aumenta proporzionalmente l'effetto della leva.**

The effect of a localized load on a slotted profile is similar to the action of a force applied to a lever (such as a crowbar): **with an increase of the distance (lever arm) from the fulcrum, the lever increases proportionally.**

Ipotesi di comportamento lineare

Hypothesis of linear behaviour

Carico interno al supporto
Inside support load

kg	cm
60	10
30	20
20	30

STESSO EFFETTO DI SOLLECITAZIONE
SAME STRESS EFFECT

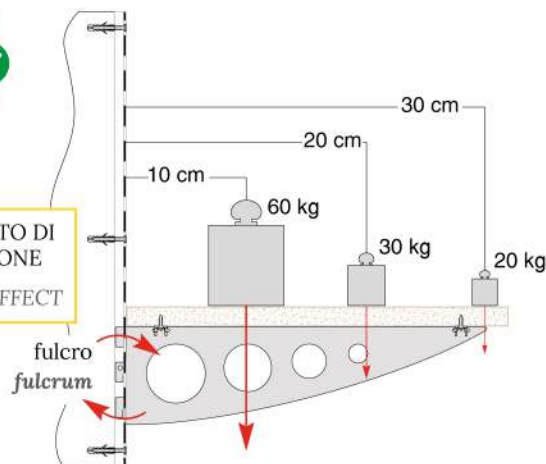

Carichi a sbalzo: comportamento non lineare

Overhang load: no more valid linear behaviour

Carico a sbalzo
Overhang load

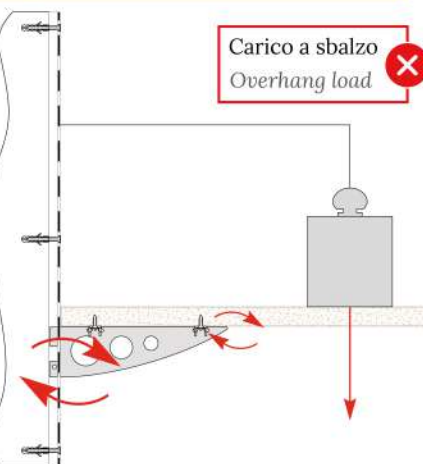

CATEGORIE DI PORTATA

LOADING CATEGORIES

Poiché dai dati tecnici finora considerati **non si può assegnare alcuna portata nominale.**

A titolo puramente indicativo abbiamo suddiviso i profili in categorie di portata subordinate alle **sezioni** ed alla **disposizioni degli ancoraggi.**

According to the technical data provided in these pages, it becomes very difficult to assign a nominal loading capacity in average conditions.

Anyway the profiles can be divided into the following loading categories, considering the **section dimension** and how the **fixings are positioned.**



ALTA
HIGH

- Profili**
- con fissaggi doppi
 - con tanti punti di ancoraggio
 - inseriti all'interno di montanti
- Profiles**
- with double fixings
 - with many anchor points
 - inserted into the uprights

NB1 / NB2
LMK + HLE
CG1 / CG2
PK1 / PK2
RMC + TCN
RP1 / RP2
RDC + RD2
FDC + RD2



MEDIA
MEDIUM

- Profili**
- con fissaggi doppi con passo maggiore di 20 cm
 - con fissaggi su un lato a meno di 20 cm di distanza
- Profiles**
- with double fixings with more than 20 cm pitch
 - with single side fixings at less than 20 cm distance

NB7 / NB3
CR1 / CR2
CG7 / PK7



BASSA
LOW

- Profili**
- con fissaggi su un lato con passo maggiore di 20 cm
 - CONCEPITI PER INCASSO con sezioni contenute
- Profiles**
- with single side fixings at more than 20 cm
 - profiles with restrained section
CONCEIVED TO BE EMBEDDED

CR7
serie ad
incasso

CR7
embedded
series

Quote espresse in millimetri.
Dimensions are in millimeters.

Accessori correlati
Related accessories

Fit
ART