



MODULO PREVENTIVO ANTE / PORTE SU MISURA

NOME / AZIENDA _____

DESTINAZIONE MERCE _____

RIFERIMENTO _____

Il presente modulo è necessario in fase di preventivo per ordinare le ante in alluminio su misura.

Compilare dettagliatamente il modulo e inviare all'indirizzo mail : info@tuttoferramenta.it

COLORE TELAIO ALLUMINIO

- AL1 – ALLUMINIO ANODIZZATO OPACO
- EE - ALLUMINIO EFFETTO SATINATO
- C35 – ALLUMINIO NERO ANODIZZATO
- GL – ALLUMINIO CROMO EFFETTO LUCIDO
- HGL – ALLUMINIO LUCIDO
- GOLD - ORO
- A – ANTRACITE OPACO ANODIZZATO
- C34- MATT

(attenzione non tutti i colori sono applicabili al profilo scelto, verificare se selezionato ● nella tabella del catalogo)

NUMERO ANTE : _____

DIMENSIONI: A: MM

 B: MM

QUANTITA' CERNIERE: _____

CERNIERE LATO: DESTRO SINISTRO

POSIZIONE CERNIERE:

 distanza dall'alto C: MM

 distanza da base D: MM

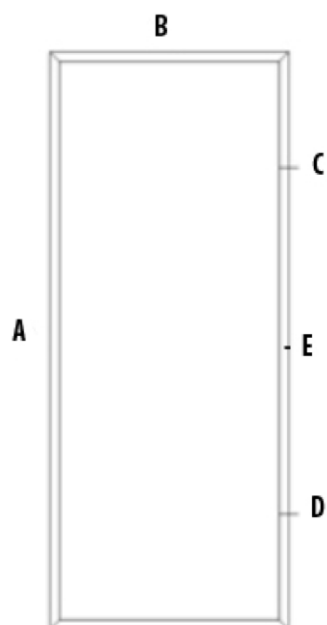

TIPOLOGIA DI PROFILO

Specifica tipo di profilo scelto : _____

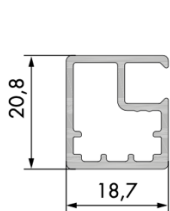

SAS 001

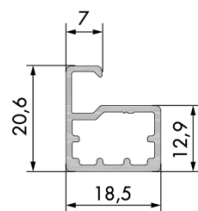

SAS 099

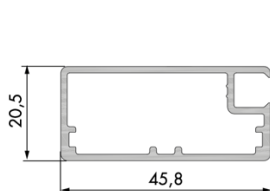

SAS 006

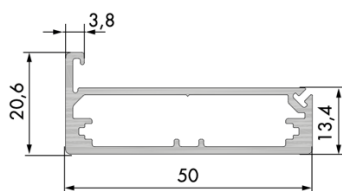

SAS 878

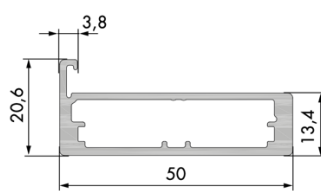

SAS 877

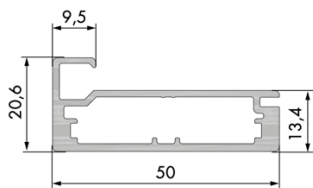

SAS 077

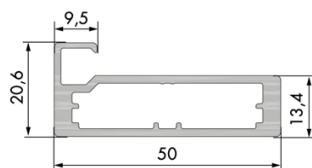

SAS 007

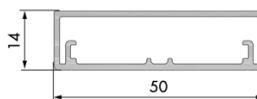

SAS 808

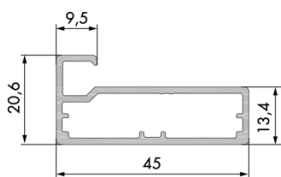

SAS 003

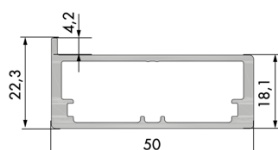

SAS 088

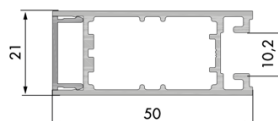

SAS 067

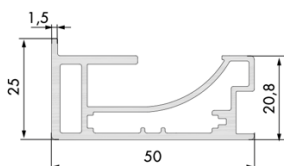

SAS 788 L

TIPOLOGIA VETRO

NO VETRO

Specificare:

VETRO ACIDATO

VETRO TRASPARENT

EXTRA – TEMPERATO

LAVORAZIONI

NO CERNIERE

FORO CERNIERA:

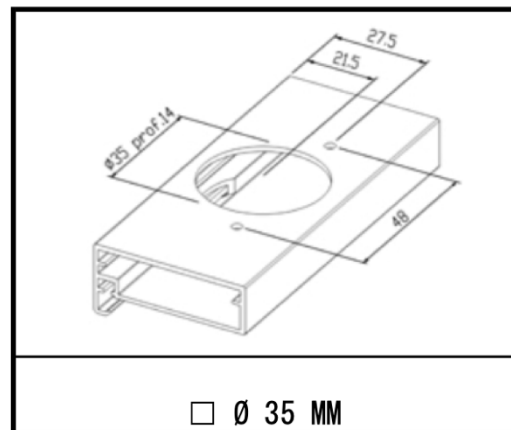
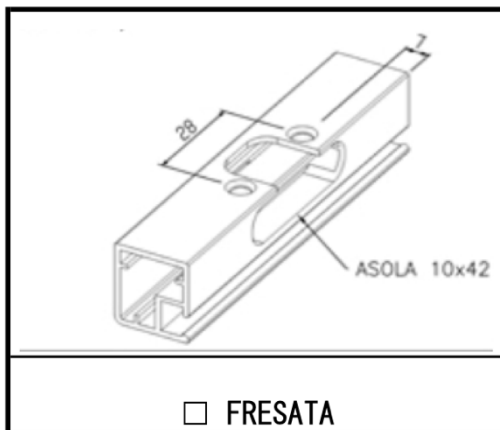

La scelta delle cerniere e delle basette dovrà essere autonoma da parte del cliente, vi invitiamo a visitare la categoria di prodotti di tuttoferramenta.it dedicata alle cerniere per mobile.

TUTTOFERRAMENTA – FEREXPERT SPA

Via Nassar, 16/e - 37026 Settimo di Pescantina (VR)
Tel. +39 045 500051 - E-mail: info@tuttoferramenta.it Codice Fiscale / Partita IVA 03098550373 - 264408 CCIAA BO