

**ISTRUZIONE MONTAGGIO CON ROSETTA LESS IS FINE 50x4 TONDA E QUADRA (MONTAGGIO CON VITI LEGNO).
INSTALLATION SCHEME FOR LESS IS FINE 50x4 ROUND AND SQUARE ROSE (WOOD SCREWS)**

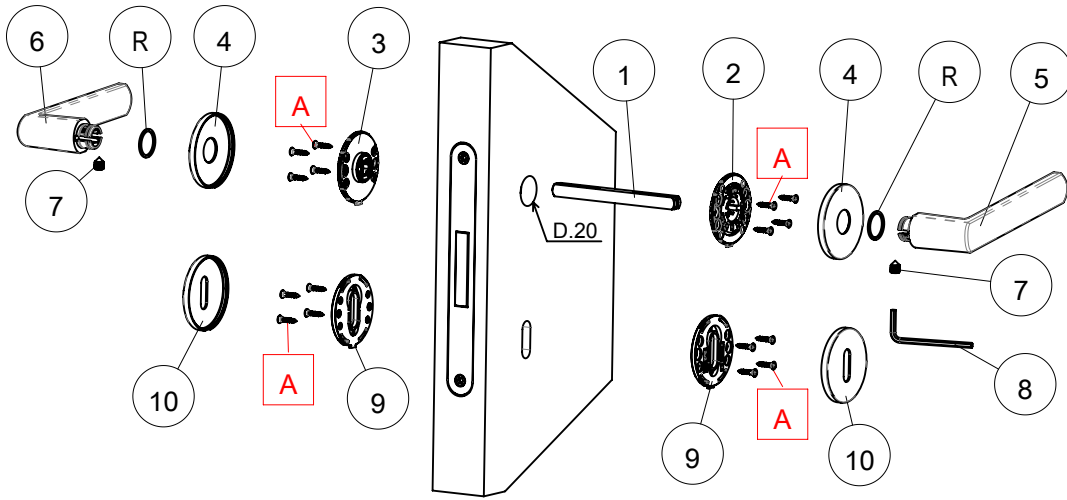

1	FERRO QUADRO	SQUARE SPINDLE
2	SOTTO ROSETTA CON MOLLA DESTRA	RIGHT HAND SPRING INNER ROSE
3	SOTTO ROSETTA CON MOLLA SINISTRA	LEFT HAND SPRING INNER ROSE
4	ROSETTA	ROSE COVER
5	IMPUGNATURA DESTA	RIGHT HAND LEVER
6	IMPUGNATURA SINISTRA	LEFT HAND LEVER
7	VITE GRANO PER FISSAGGIO IMPUGNATURE	GRUB SCREW
8	CHIAVE ESAGONALE PER VITE GRANO	ALLEN KEY
9	SOTTO BOCCHETTA - PATENT / YALE	KEYHOLE/EURO CYLINDER PROFILE INNER NYLON BASE
10	BOCCHETTA PATENT / YALE	KEYHOLE /EURO CYLINDER PROFILE ESCUTCHEON COVER
A	VITI PER FISSAGGIO SOTTO ROSETTE/SOTTO BOCCHETTE	SCREW FIXINGS
R	RONDELLA NYLON	NYLON WASHER

SOTTO ROSETTA SINISTRA
LEFT HAND SPRING INNER ROSE

SC.01

SOTTO ROSETTA DESTRA
RIGHT HAND SPRING INNER ROSE

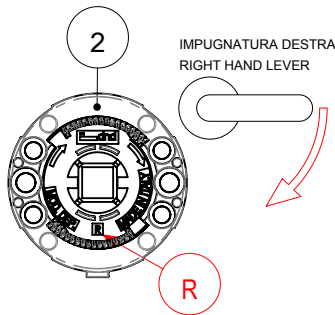
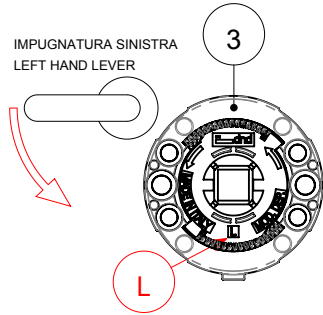

SC.02

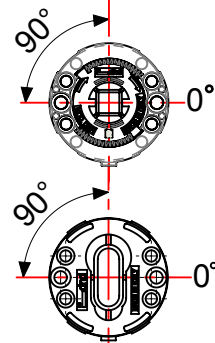

FIG.01: INSERIRE NELLA SERRATURA IL FERRO QUADRO (1) MANTENENDO LA SCANALATURA VERSO IL BASSO.

FIG.02: FARE ATTENZIONE A MANTENERE LA STESSA SPORGENZA DEL FERRO QUADRO (1) SU ENTRAMBI I LATI DEL BATTENTE.

FIG.03 : RISPETTARE LA CORRETTA PERPENDICOLARITA' DEL FERRO QUADRO (1) RISPETTO AL PIANO DELLA PORTA.

FIG.01: PLACE THE SQUARE SPINDLE (1) THROUGH THE LOCK WITH THE GROOVE FACING DOWN.

FIG.02: PAY ATTENTION TO KEEP THE SAME PROJECTION OF THE SQUARE SPINDLE (1) ON BOTH SIDES OF THE DOOR LEAF.

FIG.03 :KEEP THE CORRECT PERPENDICULARITY OF THE SQUARE SPINDLE (1) WITH RESPECT TO THE DOOR PLANE.

Fig.01

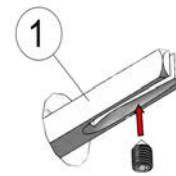

Fig.02

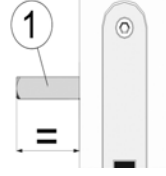
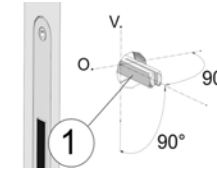
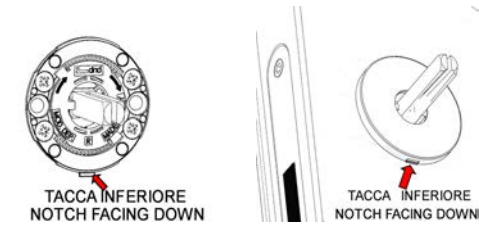

Fig.03



FISSARE LE SOTTO ROSETTE CON LE VITI FORNITE RISPETTANDO LO SCHEMA "SC.01" E "SC.02" E LA POSIZIONE INFERIORE DELLA TACCA DI POSIZIONAMENTO ROSETTA, APPLICARE LE ROSETTE (4).

FIX THE SPRING INNER ROSE BY USING THE PROVIDED SCREWS, FOLLOWING THE DIAGRAM SC01 AND SC02, AND THE LOWER POSITION OF THE INNER ROSES NOTCH, APPLY THE ROSES COVERS (4).



INSERTO DA ELIMINARE QUANDO
USATO CON BOCCHETTA FORO YALE

WHEN USING EURO CYLINDER PROFILE
ESCUTCHEONS, REMOVE THE CENTRAL OVAL
SECTION FROM THE NYLON INNER ROSE BASE

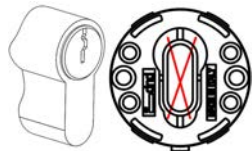

FISSARE LE SOTTO BOCCHETTE CON LE VITI FORNITE RISPETTANDO LO SCHEMA "SC.02" E LA
POSIZIONE DELLA TACCA INFERIORE ABBINAMENTO BOCCHETTA , APPLICARE LA BOCCHETTA (10).

FIX THE KEYHOLE/EURO CYLINDER PROFILE NYLON INNER ROSE BASE BY USING THE PROVIDED
SCREWS, FOLLOWING THE DIAGRAM SC02, AND THE LOWER POSITION OF THE INNER NYLON
ROSE NOTCH , APPLY THE ROSE COVERS (10) BY PRESSURE.

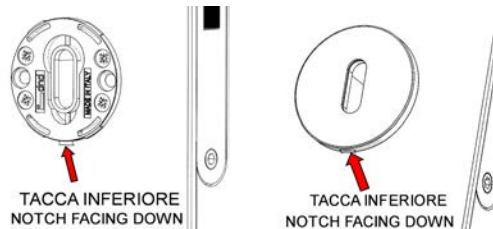

INSERIRE SUL COLLETTO DELL'IMPUGNATURA LA RONDELLA IN NYLON (R)

INSERT THE NYLON WASHER (R) ON THE COLLAR OF THE HANDLE.

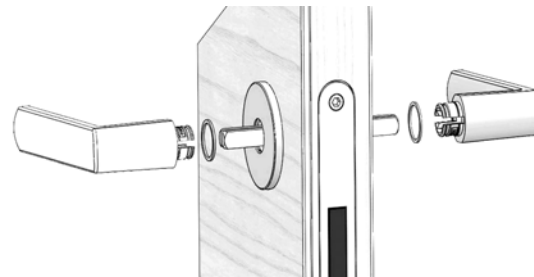

INSERIRE LE IMPUGNATURE (5/6) SUL FERRO QUADRO (1) , FISSARE LA PRIMA IMPUGNATURA
CON LA VITE GRANO (7) CON LA CHIAVE (8) , FISSARE LA SECONDA IMPUGNATURA CON LA VITE GRANO (7)
TENENDO ENTRAMBE LE IMPUGNATURE BENE IN APOGGIO SULLE ROSETTE.

SLIDE BOTH LEVER HANDLES (6/7) ON THE SQUARE SPINDLE (1). FIX THE LEVER HANDLES BY KEEPING THEM
FIRMLY AGAINST THE ROSES WHILE TIGHTENING THE GRUB SCREW (7) WITH THE ALLEN KEY (8).

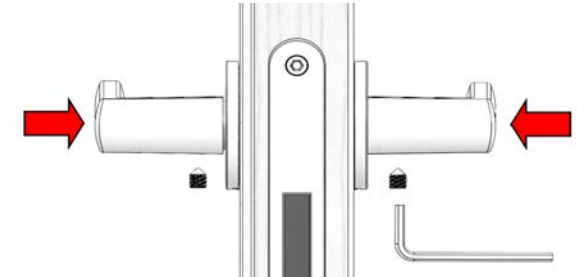

**ISTRUZIONE MONTAGGIO NOTTOLINO WC CON ROSETTA TONDA E QUADRA LESS IS FINE 50x4 (MONTAGGIO CON VITI LEGNO).
INSTALLATION SCHEME FOR LESS IS FINE 50x4 ROUND AND SQUARE ROSE (WOOD SCREWS)**

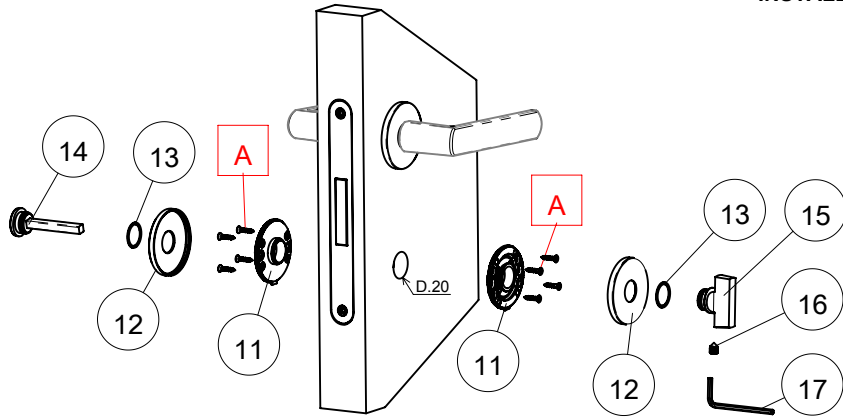

11	SOTTO ROSETTA SENZA MOLLA CON BUSSOLA NERA PER NOTTOLINO	INNER ROSE WITHOUT SPRING WITH NYLON BLACK BUSH FOR TURN & RELEASE
12	ROSETTA	ROSE COVER
13	RONDELLA IN NYLON	NYLON WASHER
14	NOTTOLINO EMERGENZA ESTERNO QUADRO mm6	EMERGENCY RELEASE
15	NOTTOLINO GIREVOLE INTERNO	PRIVACY SNIB TURN
16	VITE GRANO PER FISSAGGIO NOTTOLINO INTERNO GIREVOLE	GRUB SCREW TO FIX THE PRIVACY SNIB TURN
17	CHIAVE ESAGONALE PER VITE GRANO	ALLEN KEY
A	VITI FISSAGGIO SOTTOROSETTE	SCREW FIXINGS

SC. 03

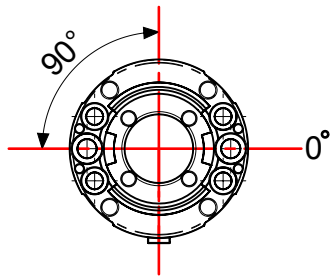

POSIZIONARE LE SOTTO ROSETTE (11) SULLA PORTA INSERIRE IL NOTTOLINO DI EMERGENZA ESTERNO (14) ED IL NOTTOLINO GIREVOLE INTERNO (15), IN MODO CHE LE SOTTO ROSETTE SIANO CENTRATE CON IL QUADRO DELLA SERRATURA.
PLACE THE INNER ROSES (11) ON THE DOOR, INSERT THE EMERGENCY RELEASE (14) AND THE PRIVACY SNIB TURN (15) PAYING ATTENTION THAT THE INNER ROSES ARE CENTERED WITH THE SQUARE HOLE IN THE LOCK.

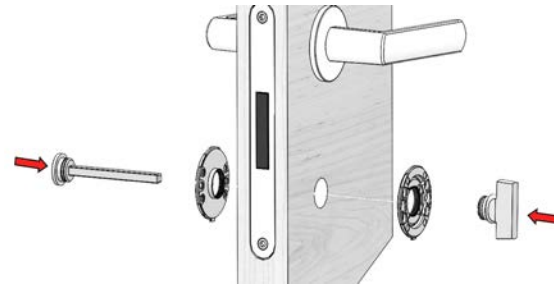

FISSARE LE SOTTO ROSETTE (11) CON LE VITI (A) FORNITE RISPETTANDO LO SCHEMA "SC.03" E LA POSIZIONE INFERIORE DELLA TACCA .
FIX THE INNER ROSES (11) BY USING THE PROVIDED SCREW FIXINGS (A) FOLLOWING THE DIAGRAM "SC.03" AND THE LOWER POSITION OF THE INNER ROSE NOTCH.

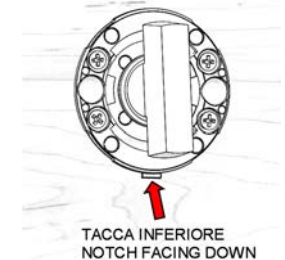

ESTRARRE IL NOTTOLINO GIREVOLE INTERNO (15) ED IL NOTTOLINO EMERGENZA ESTERNO (14).

REMOVE THE PRIVACY SNIB TURN (15) AND THE EMERGENCY RELEASE (14).

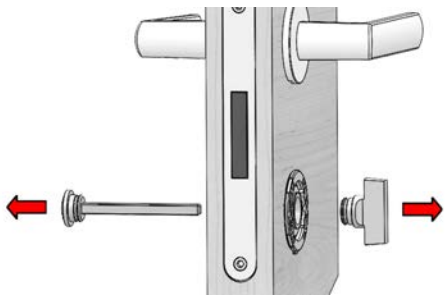

APPLICARE SULLE SOTTO ROSETTE (11) LE ROSETTE (12) RISPETTANDO LA POSIZIONE DELLA TACCA INFERIORE.

APPLY THE ROSE COVERS (12) ON THE INNER ROSES (11) PAYING ATTENTION TO THE LOWER POSITION OF THE NOTCH.

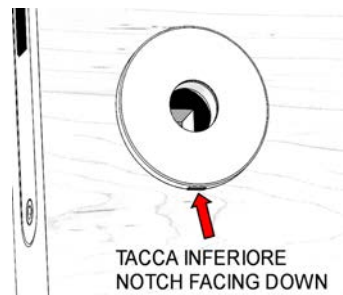

INSERIRE LE RONDELLE IN NYLON (13) SUL NOTTOLINO EMERGENZA (14) E NOTTOLINO GIREVOLE (15) INSERIRLI NEL FORO DELLE ROSETTE (12).

SLIDE THE NYLON WASHERS ON THE EMERGENCY RELEASE (14) AND PRIVACY SNIB TURN (15), INSERT THEN BOTH (14 & 15) IN THE ROSES HOLE (12).

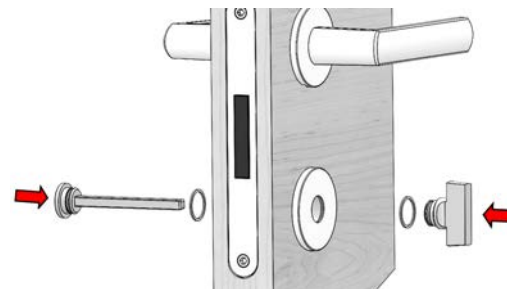

TENERE IN APPOGGIO SULLE ROSETTE E FISSARE CON LA VITE GRANO (16) UTILIZZANDO LA CHIAVE (17).

KEEP FIRMLY BOTH THE EMERGENCY RELEASE (14) AND PRIVACY SNIB TURN (15) AGAINST THE ROSES WHILE TIGHTENING THE GRUB SCREW (16) WITH THE ALLEN KEY (17).

