

307 W

Ruota gola Y con scarico
Wheel with discharge Y groove
Galet gorge Y avec décharge
Schiebetorrolle mit Y-Rille
Rueda canal Y con descarga
Колесо с пазом Y со стоком

2 CUSCINETTI
2 BEARINGS



CODE	ART.	B	C	D	L	Perno Wheel Pin	Portata ruota-Kg Capacity wheel-Kg	Box info	
								Pcs per pack	Kg
11503040 001	307Y-100	12,5	34	∅ 98	28	M14 x 70	400	8	11,40
11503050 001	307Y-120	12,5	34	∅ 117	28	M14 x 70	420	6	12,50
11503060 001	307Y-140	12,5	44	∅ 137	31	M16 x 70	540	2	6,60
11503070 001	307Y-160	12,5	44	∅ 157	33	M16 x 70	560	2	9,20
11503080 001	307Y-200	12,5	44	∅ 197	33	M16 x 70	600	2	14,80

Finishing: Zincato / Galvanized

Categoria commerciale: 1M

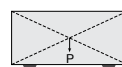
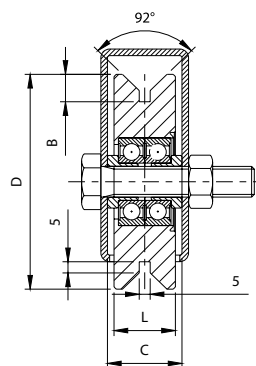

Peso uniformemente distribuito
Equally distributed weight

310 W

Ruota gola semitonda
Wheel with half-rounded groove
Galet avec gorge demi-ronde
Schiebetorrolle mit Rundrille
Rueda canal semirredondo
Колесо с полукруглым пазом

1 CUSCINETTO
1 BEARING



CODE	ART.	B	C	D	L	R	Perno Wheel Pin	Portata ruota-Kg Capacity wheel-Kg	Box info		
									Pcs per pack	Kg	
11504501 001	310-40	4	16	∅ 40	12	4,5	M8 x 30	50	50	5,10	
11504505 001	310-50	4	16	∅ 50	12	4,5	M8 x 30	70	30	4,70	
11504510 001	310-60	4	24	∅ 60	16,5	4,5	M10 x 45	100	12	4,10	
11504515 001	310-70	7,5	34	∅ 68	20	8,5	∅ 15 ∅ 15	M14 x 70	190	12	5,80
11504520 001	310-80	7,5	34	∅ 78	20	8,5	∅ 15 ∅ 15	M14 x 70	200	10	6,40
11504525 001	310-80S	9,5	34	∅ 78	24	10,3	∅ 19 ∅ 19	M14 x 70	200	10	6,60
11504530 001	310-90	7,5	34	∅ 88	21	8,5	∅ 15 ∅ 15	M14 x 70	210	8	6,90
11504535 001	310-90S	9,5	34	∅ 88	24	10,3	∅ 19 ∅ 19	M14 x 70	210	8	7,00
11504540 001	310-100	7,5	34	∅ 98	21	8,5	∅ 15 ∅ 15	M14 x 70	220	8	8,70
11504545 001	310-100S	9,5	34	∅ 98	24	10,3	∅ 19 ∅ 19	M14 x 70	220	8	8,80
11504550 001	310-120	9,5	34	∅ 117	25	10,3	∅ 19 ∅ 19	M14 x 70	240	6	10,40
11504560 001	310-140	9,5	44	∅ 137	25	10,3	∅ 19 ∅ 19	M16 x 70	270	2	5,00
11504570 001	310-160	9,5	44	∅ 157	25	10,3	∅ 19 ∅ 19	M16 x 70	290	2	6,60
11504580 001	310-200	9,5	44	∅ 197	25	10,3	∅ 19 ∅ 19	M16 x 70	330	2	10,70

Finishing: Zincato / Galvanized

Categoria commerciale: 1M

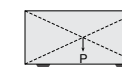
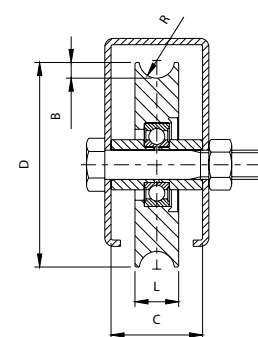

Peso uniformemente distribuito
Equally distributed weight

308 W

Ruota gola Y raccordata
Wheel with Y-rounded groove
Galet avec gorge Y arrondie
Schiebetorrolle mit Y-Rille abgerundeter Führung
Rueda canal Y con racor
Колесо с пазом Y с патрубком

1 CUSCINETTO
1 BEARING



CODE	ART.	A	B	C	D	L	Perno Wheel Pin	Portata ruota-Kg Capacity wheel-Kg	Box info	
									Pcs per pack	Kg
11503505 001	308-50	7	7,5	24	∅ 50	17	M10 x 45	100	12	2,50
11503510 001	308-60	7	7,5	24	∅ 60	16,5	M10 x 45	100	12	3,50
11503520 001	308-80	8	10	34	∅ 78	20	M14 x 70	200	10	5,50

Finishing: Zincato / Galvanized

Categoria commerciale: 1M

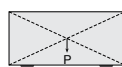
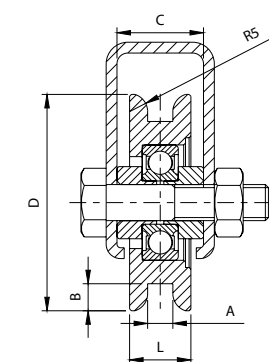

Peso uniformemente distribuito
Equally distributed weight

ART. 310-80

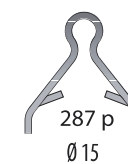
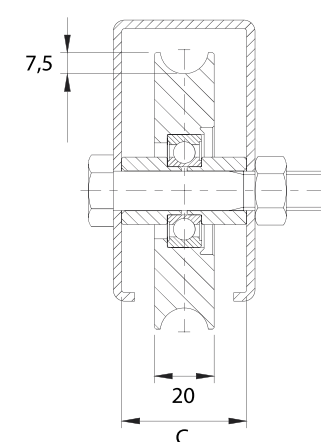

ART. 310-80S

