





# 450 □ P2 S □ □ 2

- |    |   |   |
|----|---|---|
| 09 | 0   | 0   |
| 10 | 1   | 1   |
| 11 | 2   | 2   |
| 12 | 3   | 4   |
| 13 | 4   | 5   |
| 14 |  |  |
| 15 |   |   |
| 16 |   |   |

H<sub>cm</sub>

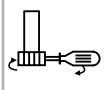
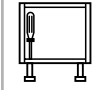
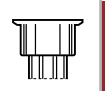







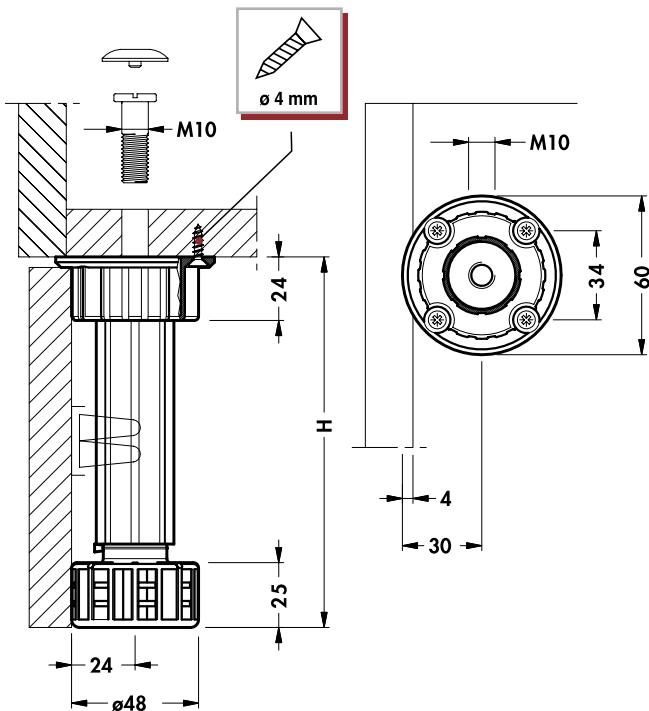







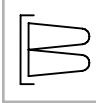

+20mm -5mm			Ø28mm
	ABS	CTBA	

 800 H<sub>cm</sub> 10-12-15

 1600 H<sub>cm</sub> 09-11-13-14-16



9		1	868 00 Z1 S1 00		666
		2	868 00 Z1 S2 00		666
		3	868 00 Z1 S3 00		667
9		1	810 37 01 00 00		656
		2	810 37 02 00 00		656
		4	810 37 04 00 00		656
		5	810 37 55 00 00		656
9		202	600		606
		203	601		606
		204	602		606
		225	606		606
		H 11-16		H 12-16	
		226	607-609		614
		228	611		614
		230	612-613		614
		235	614		614