

# 829

mm.69,8x15,9

Cerniere invisibili per porte  
Invisible hinges for doors  
Bisagras ocultas para puertas



Cod. CI000829 NIKOO  
Cod. CI000829 OTT00  
Cod. CI000829 BRO00

Pack. 20

### CARATTERISTICHE:

- Realizzata in acciaio e zama in 3 diverse finiture
- Adatta per ante con spessore minimo di 22 mm
- Lunghezza totale 69,8 mm
- Profondità 23 mm
- Portata fino a 25 kg
- Simmetria di cava

### MAIN FEATURES:

- Produced in steel and zamak in 3 different finishes
- Suitable for doors of 22 mm min. thickness
- Total length 69,8 mm
- Depth 23 mm
- Load capacity up to 25 kg
- Slot symmetry

### CARACTERÍSTICAS:

- Fabricada en acero y zamak en 3 acabados diferentes
- Adapta para puertas con un espesor mínimo de 22 mm
- Longitud total 69,8 mm
- Profundidad de 23 mm
- Capacidad de carga hasta 25 kg
- Simetría de corte

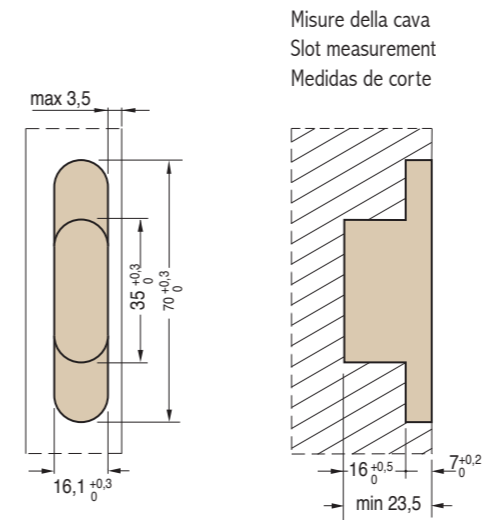
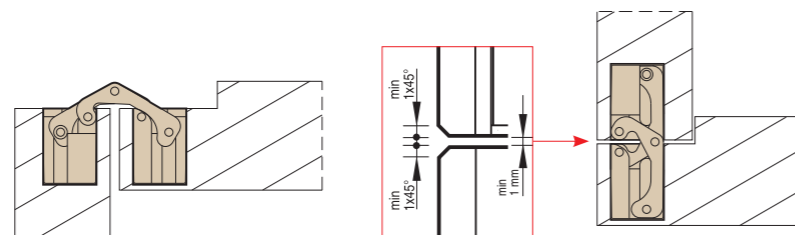
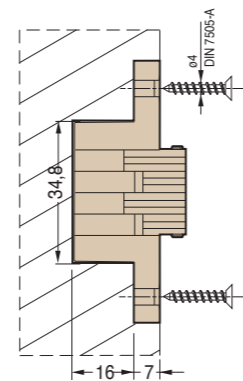
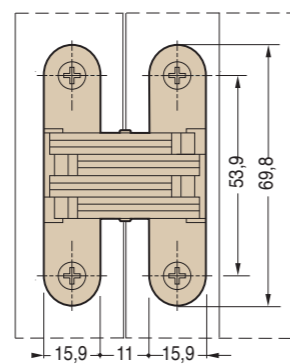

Misure della cava  
Slot measurement  
Medidas de corte

### REVERSIBILITÀ - REVERSIBILITY - REVERSIBILIDAD

Reversible per porte da 22 mm a 23 mm di spessore  
Reversible for doors from 22 mm to 23 mm thick  
Reversible para puertas de 22 mm hasta 23 mm de espesor

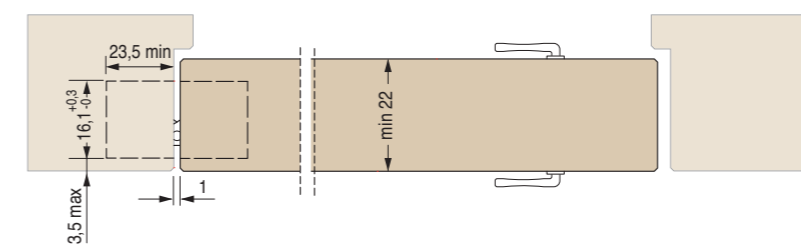
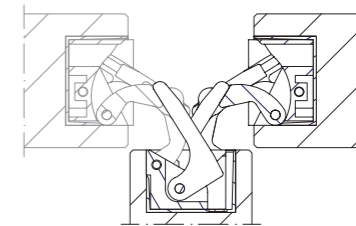

Sezione porta  
Door cross-section  
Sección de puerta

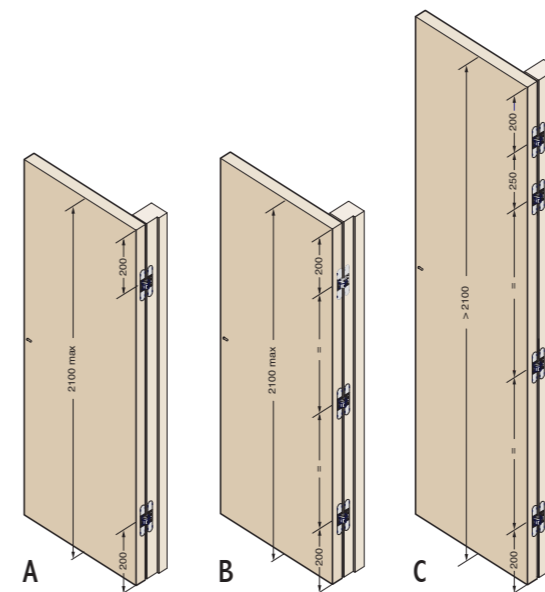

### PORTATA ANTE

Larghe fino a 850 mm  
Alte fino a 2100 mm  
A - 2 cerniere kg 15  
B - 3 cerniere kg 25  
Alte oltre 2100 mm  
C - 4 cerniere kg 25

### CAPACITY DOORS

Width up to 850 mm  
Alte fino a 2100 mm  
A - 2 hinges kg 15  
B - 3 hinges kg 25  
More than 2100 mm high  
C - 4 hinges kg 25

### CAPACIDAD PUERTAS

Anchas hasta 850 mm  
Altas hasta 2100 mm  
A - 2 bisagras kg 15  
B - 3 bisagras kg 25  
Mas altas que 2100 mm  
C - 4 bisagras kg 25

