

# 300 02 Z2 □ Z2

19  
22  
Amm

+20mm  
0mm

6



300 Kg

ABS

Fe

ZAMAK

100

3000

3000

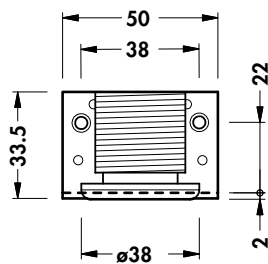
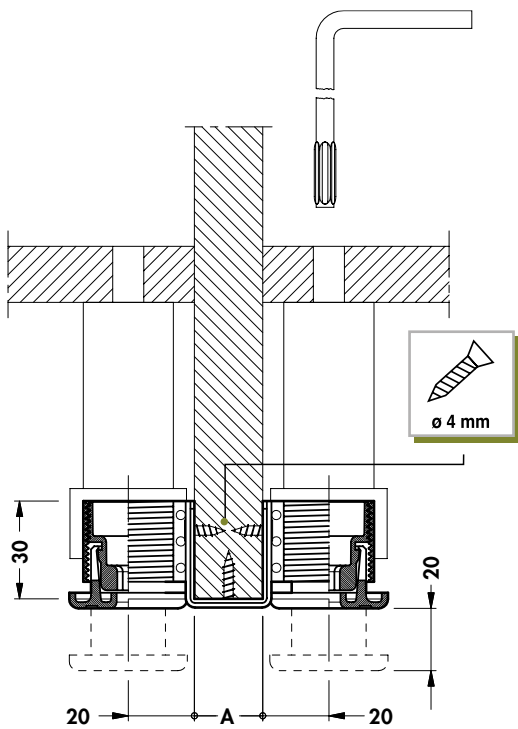
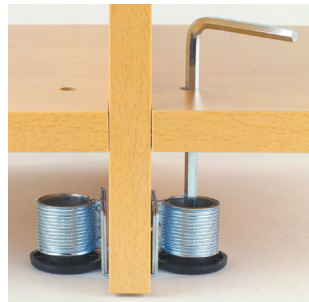
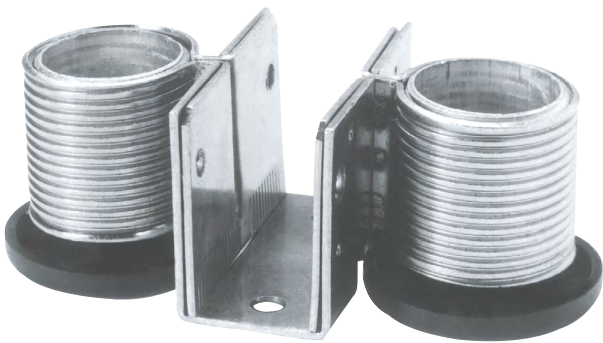

9

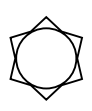
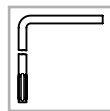

809  
638-641

9

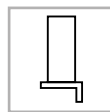

300  
615