



**Glow+**

***SALICE***

ITA





Glow+ è un sistema di scorrimento per armadi a 2, 3 o più ante sovrapposte, dotato di un rivoluzionario ammortizzatore magnetico che permette un movimento decelerato sia in apertura sia in chiusura, fluido e particolarmente silenzioso.

L'innovativa soluzione garantisce, infatti, la definitiva eliminazione della rumorosità in apertura e in chiusura e consente una maggiore facilità di apertura, annullando la tipica resistenza dei sistemi a molla.

Glow+ può essere utilizzato con ante in legno e alluminio, con un peso massimo di 70 kg. Il sistema può, tuttavia, essere fornito con un kit di potenziamento, con il quale è possibile utilizzare ante con un peso fino a 100 kg.

L'installazione di Glow+ è alquanto semplice e intuitiva, realizzabile o con viti o automaticamente con l'ausilio di clip con montaggio a pressione.

Il sistema, inoltre, può essere dotato di una copertura magnetica che consente un ulteriore arricchimento estetico.

Glow+ trova diverse applicazioni, in particolare armadi per zona living e notte.





### Informazioni tecniche

#### COMPOSIZIONE MECCANISMO

- Profili in alluminio: lega 6060T5, anodizzati argento.
- Ruote di scorrimento: cuscinetti per alta velocità.
- Carrelli superiori e inferiori: lamiera verniciata.
- Componenti interni: materiale plastico e zama.

#### CARATTERISTICHE ANTE

- Peso massimo per singola anta 70 kg.  
Con kit di potenziamento 100 kg (uniformemente distribuito).
- Spessore suddiviso in 6 categorie:
  - 1: fino a 23 mm;
  - 2: fino a 26 mm;
  - 3: fino a 30 mm;
  - 4: fino a 35 mm;
  - 5: fino a 40 mm;
  - 6: fino a 50 mm.
- Altezza da terra: 17 mm o 33 mm.
- Materiale:
  - a) legno o derivati;
  - b) telaio in metallo e vetro.
- Larghezza minima per l'applicazione dell'ammortizzatore:
  - 2 ante 600 mm;
  - 3 ante 830 mm;
  - 2 e 3 ante con kit di potenziamento 1000 mm.
- Regolazione dell'anta: verticale +5/-0 mm.

#### TIPOLOGIE APERTURE

- Glow+ è disponibile a una, due, tre o più ante, ciascuna ammortizzata sia in apertura sia in chiusura.



## Caratteristiche principali

Innovativo ammortizzatore ad azione magnetica fluido e silenzioso.

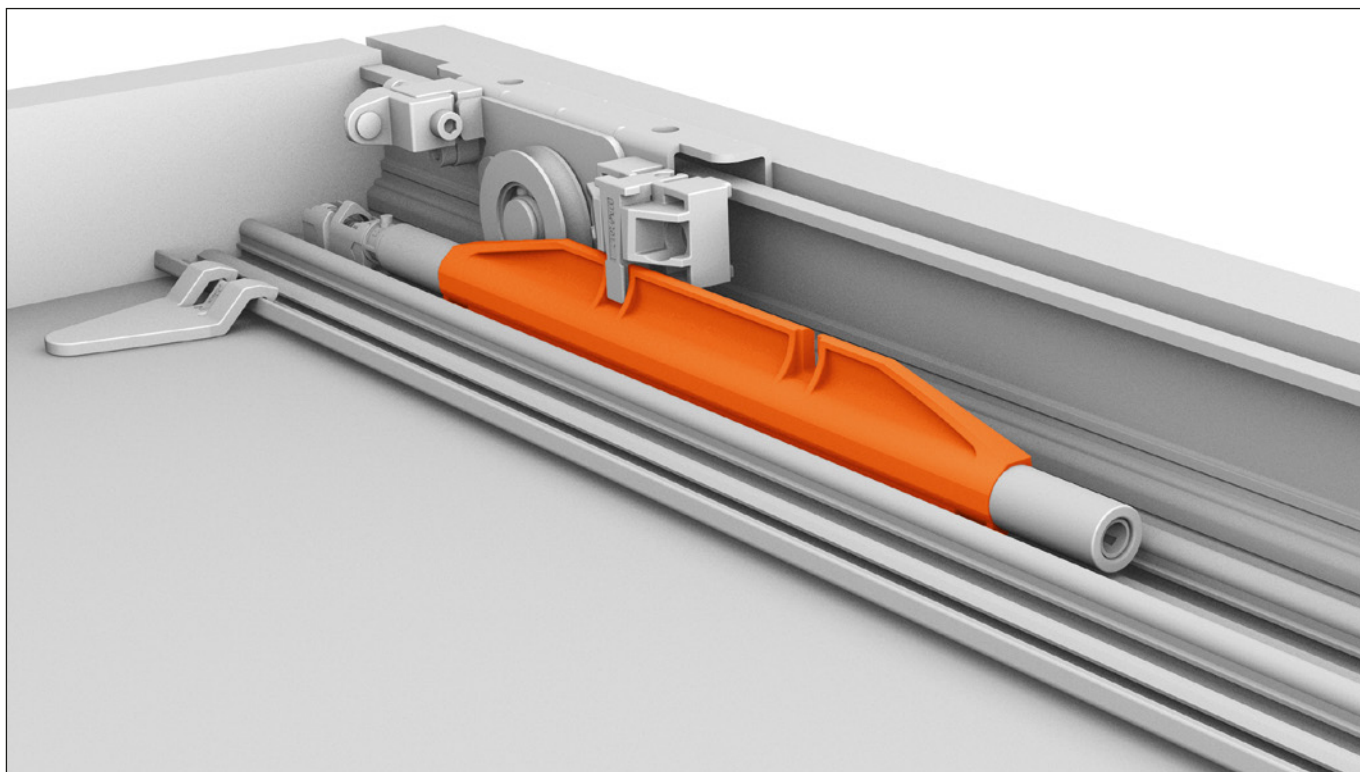

Arresti estremamente facili da montare e riposizionare.

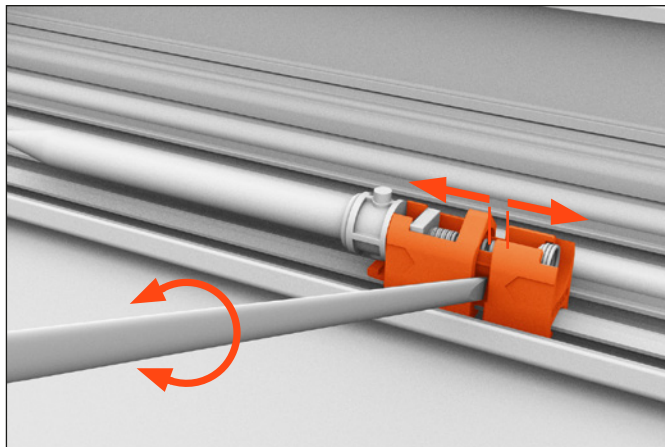

Aggancio automatico, con riarmo, fra carrello e ammortizzatore.

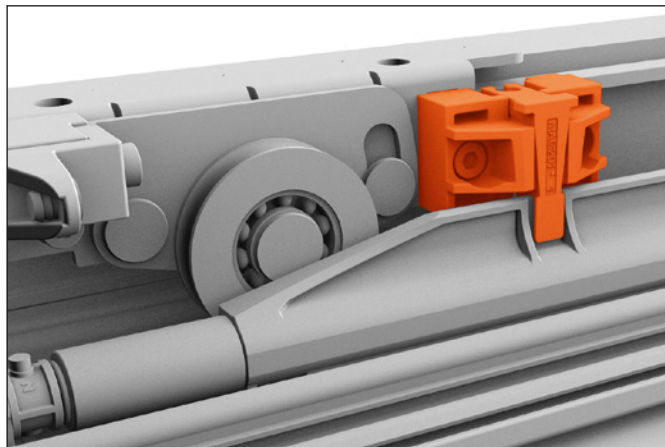

Copertura frontale del meccanismo con aggancio magnetico.

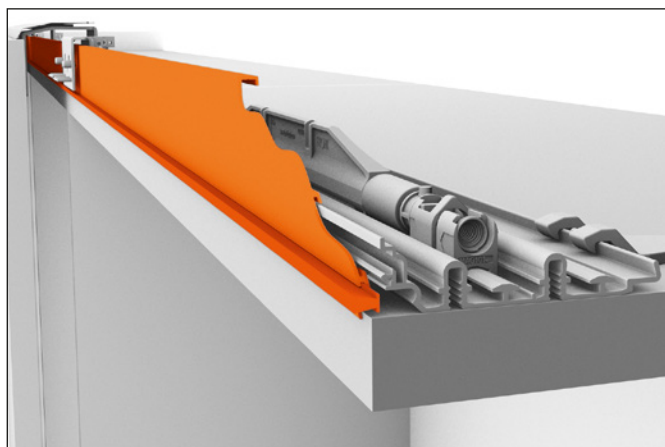

Installazione dei binari mediante clip con montaggio a pressione.



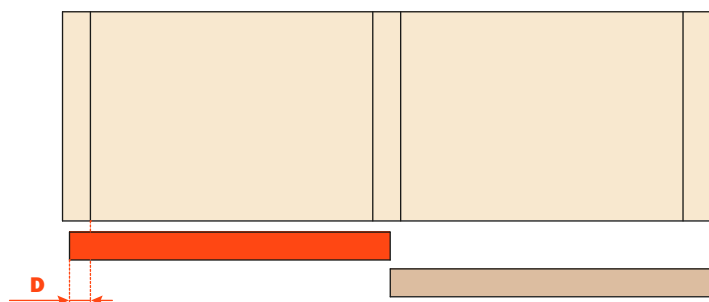
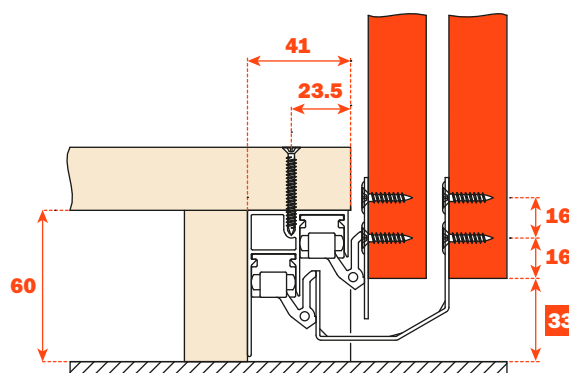
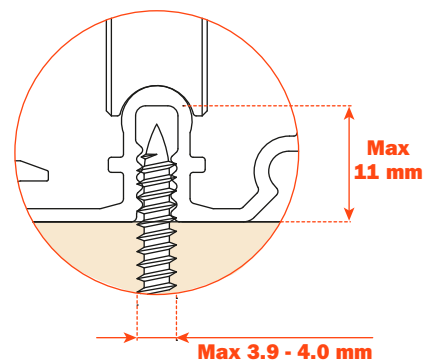
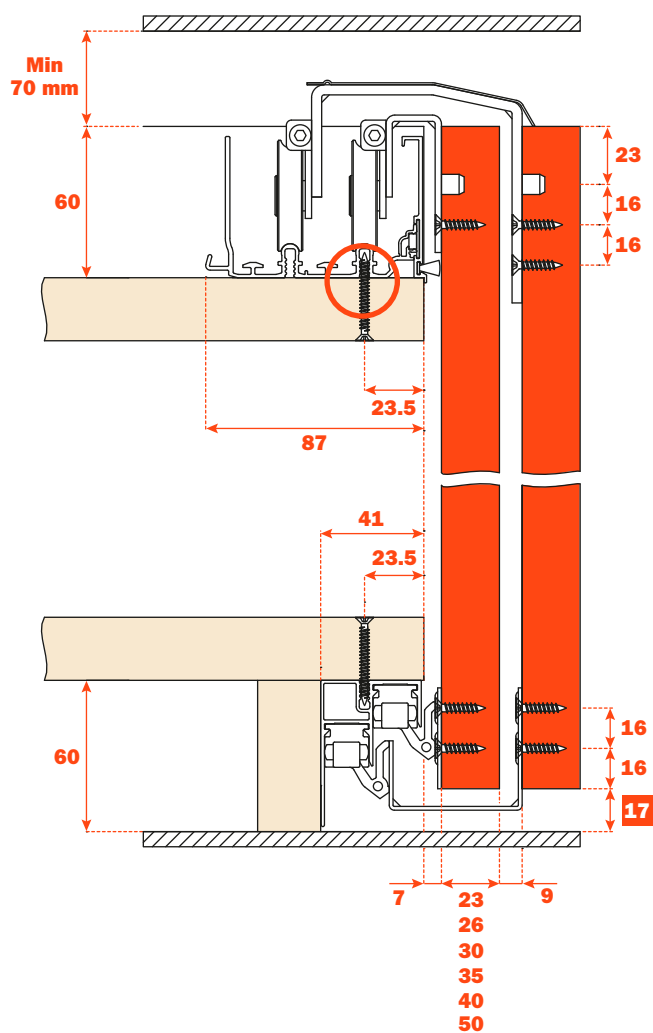

$A \text{ min} = D + 41 \text{ mm}$

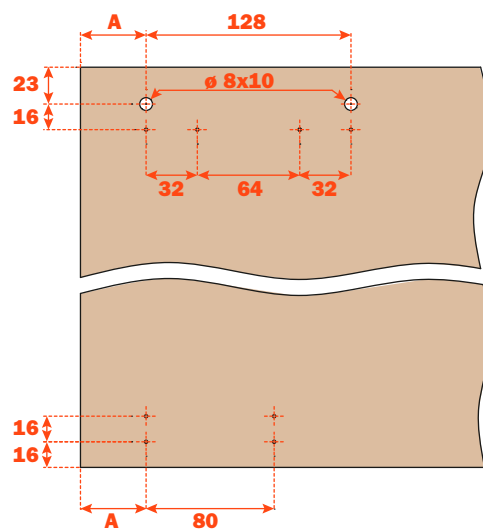



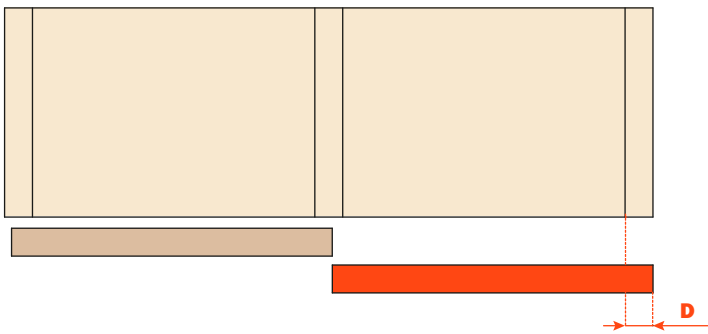
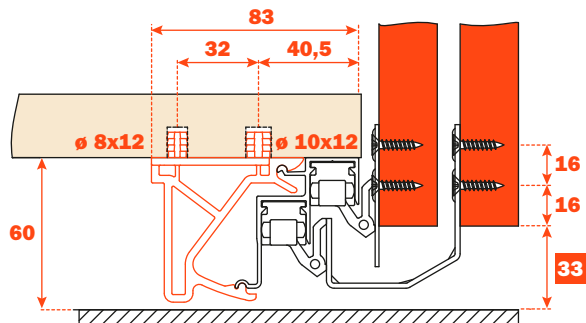
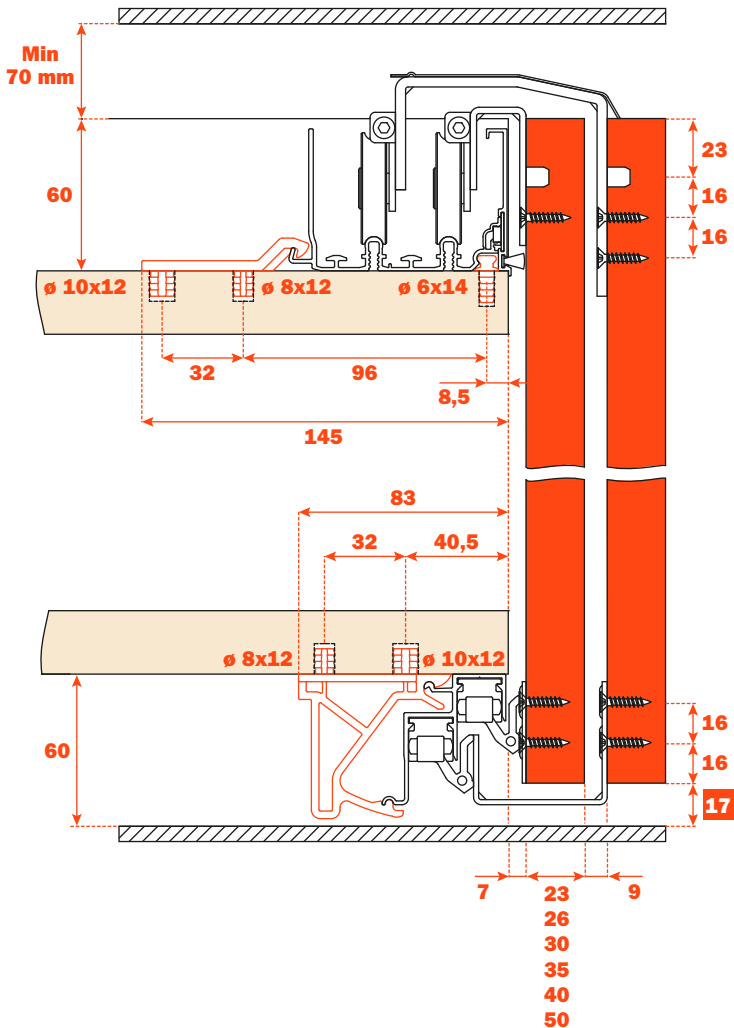



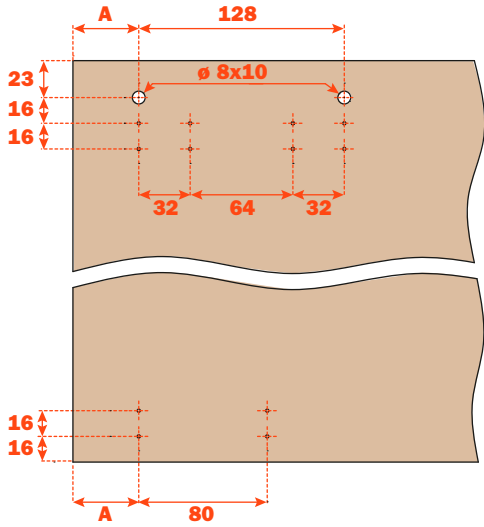



**Klik**



















**A min = D + 41 mm**







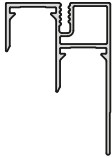
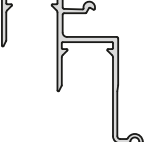

**PROFILI**

PROFILO SUPERIORE STANDARD		CODICE				FISSAGGIO	
	(mm)		(pz)	(kg)	(mm)		
Predisposto per copertura frontale	6200	VE41PIA16200AB	8	39,0	105 x 115 x 6300	<b>Klik</b> 	21152
	3100	VE41PTA13100AB	8	19,6	105 x 115 x 3200	<b>Klik</b> 	
Non predisposto per copertura frontale	6200	VE41PIB16200AB	8	39,5	105 x 115 x 6300	<b>Klik</b> 	21151
	3100	VE41PTB13100AB	8	19,8	105 x 115 x 3200	<b>Klik</b> 	



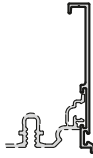

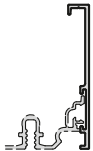



PROFILO SUPERIORE RINFORZATO		CODICE				FISSAGGIO	
	(mm)		(pz)	(kg)	(mm)		
Predisposto per copertura frontale	6200	VE41PIA26200AB	8	52,4	200 x 130 x 6300	<b>Klik</b> 	20944
	3100	VE41PTA23100AB	8	26,2	200 x 130 x 3200	<b>Klik</b> 	
Non predisposto per copertura frontale	6200	VE41PIB26200AB	8	52,6	200 x 130 x 6300	<b>Klik</b> 	20573
	3100	VE41PTB23100AB	8	26,3	200 x 130 x 3200	<b>Klik</b> 	

PROFILO INFERIORE		CODICE				FISSAGGIO	
	(mm)		(pz)	(kg)	(mm)		
	6200	VE41PIE16200AB	8	37,0	75 x 190 x 6300		21162
	3100	VE41PTE13100AB	8	18,5	75 x 190 x 3200		
	6200	VE41BIX06200AB	8	35,8	235 x 75 x 6300	<b>Klik</b>	39428
	3100	VE41BTX03100AB	8	17,9	235 x 75 x 3200	<b>Klik</b>	



























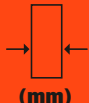







COPERTURA FRONTALE	L	CODICE	 (pz)	 (kg)	 (mm)	
	(mm)					
Con sede per spazzolino	6200	VE41BIA06200AB	8	15,7	125 x 75 x 6300	34032 
	3100	VE41BTA03100AB	8	7,80	125 x 75 x 3200	
Senza sede per spazzolino	6200	VE41BIB06200AB	8	15,02	125 x 75 x 6300	35510 
	3100	VE41BTB03100AB	8	7,50	125 x 75 x 3200	

## CARRELLI DI SCORRIMENTO ANTA INTERNA









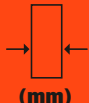

ARTICOLO	 (mm)	CODICE	 (pz)	 (kg)	 (m <sup>3</sup> )	 (mm)	
Carrello superiore destro		VE41KMCM1350DX0	30	13,0	0,016	445 x 191 x 190	
Carrello superiore sinistro		VE41KMCM1350SX0	30	13,0	0,016	445 x 191 x 190	
Carrello inferiore	17	VE41KMGLW310	30	2,9	0,008	295 x 292 x 100	
	33	VE41KMGLW320	30	3,6	0,008	295 x 292 x 100	

**CARRELLI DI SCORRIMENTO ANTA ESTERNA**













ARTICOLO	 (mm)	 (mm)	CODICE	 (pz)	 (kg)	 (m <sup>3</sup> )	 (mm)	
<b>Carrello superiore destro</b>	≤ 23		<b>VE41KMCM1370DX0</b>	<b>30</b>	<b>30,0</b>	<b>0,038</b>	<b>460 x 460 x 180</b>	
<b>Carrello superiore sinistro</b>	≤ 23		<b>VE41KMCM1370SX0</b>	<b>30</b>	<b>30,0</b>	<b>0,038</b>	<b>460 x 460 x 180</b>	
<b>Carrello inferiore</b>	≤ 23	<b>17</b>	<b>VE41KMGLW311</b>	<b>30</b>	<b>6,3</b>	<b>0,011</b>	<b>330 x 310 x 110</b>	
	≤ 23	<b>33</b>	<b>VE41KMGLW321</b>	<b>30</b>	<b>6,8</b>	<b>0,011</b>	<b>330 x 310 x 110</b>	
<b>Carrello superiore destro</b>	≤ 26		<b>VE41KMCM1375DX0</b>	<b>30</b>	<b>30,5</b>	<b>0,038</b>	<b>460 x 460 x 180</b>	
<b>Carrello superiore sinistro</b>	≤ 26		<b>VE41KMCM1375SX0</b>	<b>30</b>	<b>30,5</b>	<b>0,038</b>	<b>460 x 460 x 180</b>	
<b>Carrello inferiore</b>	≤ 26	<b>17</b>	<b>VE41KMGLW316</b>	<b>30</b>	<b>6,5</b>	<b>0,011</b>	<b>330 x 310 x 110</b>	
	≤ 26	<b>33</b>	<b>VE41KMGLW326</b>	<b>30</b>	<b>6,9</b>	<b>0,011</b>	<b>330 x 310 x 110</b>	

ARTICOLO	 (mm)	 (mm)	CODICE	 (pz)	 (kg)	 (m <sup>3</sup> )	 (mm)	
<b>Carrello superiore destro</b>	≤ 30		VE41KMCMI371DX0	30	31,0	0,038	460 x 460 x 180	
<b>Carrello superiore sinistro</b>	≤ 30		VE41KMCMI371SX0	30	31,0	0,038	460 x 460 x 180	
<b>Carrello inferiore</b>	≤ 30	17	VE41KMGLW312	30	6,7	0,011	330 x 310 x 110	
	≤ 30	33	VE41KMGLW322	30	7,1	0,011	330 x 310 x 110	
<b>Carrello superiore destro</b>	≤ 35		VE41KMCMI372DX0	30	32,0	0,043	530 x 460 x 180	
<b>Carrello superiore sinistro</b>	≤ 35		VE41KMCMI372SX0	30	32,0	0,043	530 x 460 x 180	
<b>Carrello inferiore</b>	≤ 35	17	VE41KMGLW313	30	7,0	0,022	390 x 310 x 190	
	≤ 35	33	VE41KMGLW323	30	7,4	0,022	390 x 310 x 190	
<b>Carrello superiore destro</b>	≤ 40		VE41KMCMI374DX0	30	33,0	0,043	530 x 460 x 180	
<b>Carrello superiore sinistro</b>	≤ 40		VE41KMCMI374SX0	30	33,0	0,043	530 x 460 x 180	
<b>Carrello inferiore</b>	≤ 40	17	VE41KMGLW315	30	7,3	0,011	330 x 310 x 110	
	≤ 40	33	VE41KMGLW325	30	7,7	0,011	330 x 310 x 110	

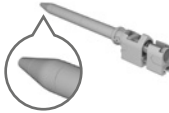
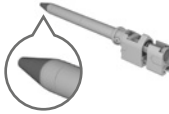
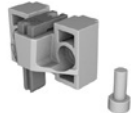











**CARRELLI DI SCORRIMENTO ANTA ESTERNA**

ARTICOLO	 (mm)	 (mm)	CODICE	 (pz)	 (kg)	 (m <sup>3</sup> )	 (mm)	
<b>Carrello superiore destro</b>	≤ 50		<b>VE41KMCM1373DX0</b>	<b>30</b>	<b>34</b>	<b>0,043</b>	<b>530 x 460 x 180</b>	
<b>Carrello superiore sinistro</b>	≤ 50		<b>VE41KMCM1373SX0</b>	<b>30</b>	<b>34</b>	<b>0,043</b>	<b>530 x 460 x 180</b>	
<b>Carrello inferiore</b>	≤ 50	<b>17</b>	<b>VE41KMGLW314</b>	<b>30</b>	<b>7,7</b>	<b>0,022</b>	<b>390 x 310 x 110</b>	
	≤ 50	<b>33</b>	<b>VE41KMGLW324</b>	<b>30</b>	<b>8,1</b>	<b>0,022</b>	<b>390 x 310 x 110</b>	

## AMMORTIZZATORE E ARRESTI

ARTICOLO	CODICE					
		(pz)	(kg)	(m <sup>3</sup> )	(mm)	
Ammortizzatore magnetico 25 kg	VE41KMAMCMA0500	30	5,1	0,015	350 x 180 x 125	
Ammortizzatore magnetico 45 kg	VE41KMAMCMA1000	30	5,1	0,015	350 x 180 x 125	
Ammortizzatore magnetico 70 kg	VE41KMAMCMA2000	30	5,1	0,015	350 x 300 x 150	
Arresto per ammortizzatore magnetico 45 kg	VE41KMAMCMA5000	60	5,6	0,023	420 x 240 x 175	
Arresto per ammortizzatore magnetico 70 kg	VE41KMAMCMA5100	60	5,6	0,023	420 x 240 x 175	
Trascinatore per ammortizzatore magnetico	VE41KMAMCMA3000	30	0,7	0,005	240 x 200 x 100	
Fermo finale	VE41KMANCMI2000	60	2,4	0,003	140 x 140 x 140	
Attivatore per fermo finale	VE41KMANCMI3000	30	1,6	-	120 x 80 x 40	
Arresto inferiore	VE41KMGLW220	60	0,7	-	-	
Perno anticollisione	VE41KMGLW510	30	1,5	-	-	
Salvamaniglia	VE41KMGLW230	30	0,1	-	-	

**ACCESSORI**

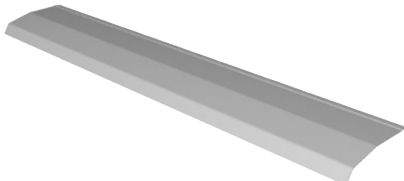
ARTICOLO	L							
	(mm)	CODICE						
<b>Piolo Frontale</b>		<b>VE41MPGLW160</b>	<b>180</b>	<b>1,0</b>	<b>0,002</b>	<b>130 x 120 x 120</b>		
<b>Aggancio superiore</b>		<b>VE41MPGLW260</b>	<b>180</b>	<b>2,2</b>	<b>0,011</b>	<b>330 x 310 x 110</b>		
<b>Aggancio inferiore</b>		<b>VE41MPGLW270.0</b>	<b>180</b>	<b>4,5</b>	<b>0,023</b>	<b>480 x 280 x 175</b>		
<b>Applicatore aggancio inferiore</b>		<b>VE41MPGLW271.0</b>	<b>30</b>	<b>1,2</b>	<b>0,005</b>	<b>250 x 200 x 100</b>		
<b>Contropiastra</b>		<b>VE41MPGLW330</b>	<b>200</b>	<b>1,2</b>	<b>-</b>	<b>120 x 80 x 40</b>		
<b>Magnete 25x6</b>		<b>VE41MPMA250603</b>	<b>200</b>	<b>0,6</b>	<b>-</b>	<b>120 x 80 x 40</b>		
<b>Spazzolino H7 grigio</b>		<b>VE41MPPB4829</b>	<b>325 m</b>	<b>2,0</b>	<b>0,030</b>	<b>350 x 350 x 250</b>		
<b>Kit agganci antiscarrucolamento (Dx+Sx)</b>		<b>VE41MPGLW280</b>	<b>30</b>	<b>0,7</b>	<b>0,005</b>	<b>234 x 174 x 119</b>		
<b>Carter copri staffe anta esterna</b> 	<b>600</b>	<b>VE41CMVS00600A</b>	<b>10</b>	<b>4,3</b>	<b>0,003</b>	<b>100 x 50 x 600</b>		
	<b>700</b>	<b>VE41CMVS00700A</b>	<b>10</b>	<b>5,1</b>	<b>0,004</b>	<b>100 x 50 x 700</b>		
	<b>800</b>	<b>VE41CMVS00800A</b>	<b>10</b>	<b>5,8</b>	<b>0,004</b>	<b>100 x 50 x 800</b>		
	<b>900</b>	<b>VE41CMVS00900A</b>	<b>10</b>	<b>6,5</b>	<b>0,005</b>	<b>100 x 50 x 900</b>		
	<b>1000</b>	<b>VE41CMVS01000A</b>	<b>10</b>	<b>7,2</b>	<b>0,005</b>	<b>100 x 50 x 1000</b>		
	<b>1100</b>	<b>VE41CMVS01100A</b>	<b>10</b>	<b>7,9</b>	<b>0,006</b>	<b>100 x 50 x 1100</b>		
	<b>1200</b>	<b>VE41CMVS01200A</b>	<b>10</b>	<b>8,7</b>	<b>0,006</b>	<b>100 x 50 x 1200</b>		
	<b>1300</b>	<b>VE41CMVS01300A</b>	<b>10</b>	<b>9,4</b>	<b>0,007</b>	<b>100 x 50 x 1300</b>		
	<b>1400</b>	<b>VE41CMVS01400A</b>	<b>10</b>	<b>10,1</b>	<b>0,007</b>	<b>100 x 50 x 1400</b>		
	<b>1500</b>	<b>VE41CMVS01500A</b>	<b>10</b>	<b>10,8</b>	<b>0,008</b>	<b>100 x 50 x 1500</b>		
	<b>1600</b>	<b>VE41CMVS01600A</b>	<b>10</b>	<b>11,5</b>	<b>0,008</b>	<b>100 x 50 x 1600</b>		
	<b>1700</b>	<b>VE41CMVS01700A</b>	<b>10</b>	<b>12,3</b>	<b>0,009</b>	<b>100 x 50 x 1700</b>		
	<b>1800</b>	<b>VE41CMVS01800A</b>	<b>10</b>	<b>13,0</b>	<b>0,009</b>	<b>100 x 50 x 1800</b>		
<b>1900</b>	<b>VE41CMVS01900A</b>	<b>10</b>	<b>13,7</b>	<b>0,010</b>	<b>100 x 50 x 1900</b>			
<b>2000</b>	<b>VE41CMVS02000A</b>	<b>10</b>	<b>14,4</b>	<b>0,010</b>	<b>100 x 50 x 2000</b>			

## ESEMPI COMPOSIZIONE CODICE

### Esempio 1

Armadio 2 ante da 900 mm, spessore 30 mm, H da terra 17 mm, profilo standard, ammortizzatore, copertura frontale con spazzolino, profili di lunghezza 3100 mm.

<b>1 x VE41PTA13100AB</b>	<b>1 x VE41KMCM1350SX0</b>	<b>2 x VE41KMGLW312</b>	<b>4 x VE41KMGLW220</b>	<b>2 x VE41MPPB4829</b>
<b>1 x VE41PTE13100AB</b>	<b>2 x VE41KMGLW310</b>	<b>2 x VE41KMAMCMA1000</b>	<b>1 x VE41KMGLW230</b>	<b>1 x VE41CMVS00900A</b>
<b>1 x VE41BTA03100AB</b>	<b>1 x VE41KMCM1371DX0</b>	<b>4 x VE41KMAMCMA5000</b>	<b>5 x VE41MPGLW330</b>	
<b>1 x VE41KMCM1350DX0</b>	<b>1 x VE41KMCM1371SX0</b>	<b>2 x VE41KMAMCMA3000</b>	<b>5 x VE41MPMA250603</b>	

### Esempio 2

Armadio 3 ante da 1200 mm, spessore 35 mm, H da terra 33 mm, profilo rinforzato, ammortizzatore, copertura frontale con spazzolino, profili di lunghezza 6200 mm.

<b>1 x VE41PIA26200AB</b>	<b>2 x VE41KMCM1350SX0</b>	<b>2 x VE41KMGLW323</b>	<b>4 x VE41KMGLW220</b>	<b>4 x VE41MPPB4829</b>
<b>1 x VE41PIE16200AB</b>	<b>4 x VE41KMGLW320</b>	<b>3 x VE41KMAMCMA2000</b>	<b>2 x VE41KMGLW230</b>	<b>1 x VE41CMVS01200A</b>
<b>1 x VE41BIA06200AB</b>	<b>1 x VE41KMCM1372DX0</b>	<b>6 x VE41KMAMCMA5000</b>	<b>8 x VE41MPGLW330</b>	
<b>2 x VE41KMCM1350DX0</b>	<b>1 x VE41KMCM1372SX0</b>	<b>3 x VE41KMAMCMA3000</b>	<b>8 x VE41MPMA250603</b>	











### Esempio 3

Armadio 2 ante da 800 mm, spessore 23 mm, H da terra 17 mm, profilo standard, senza ammortizzatore e senza copertura frontale, profili di lunghezza 3100 mm.









<b>1 x VE41PTB13100AB</b>	<b>1 x VE41KMCM1350SX0</b>	<b>1 x VE41KMCM1370SX0</b>	<b>4 x VE41KMANCMI2000</b>	<b>1 x VE41KMGLW230</b>
<b>1 x VE41PTE13100AB</b>	<b>2 x VE41KMGLW310</b>	<b>2 x VE41KMGLW311</b>	<b>2 x VE41KMANCMI3000</b>	<b>1 x VE41CMVS00800A</b>
<b>1 x VE41KMCM1350DX0</b>	<b>1 x VE41KMCM1370DX0</b>		<b>4 x VE41KMGLW220</b>	

Negli esempi sono indicate le quantità necessarie per un armadio; per i quantitativi minimi di acquisto si rinvia alle tabelle precedenti.



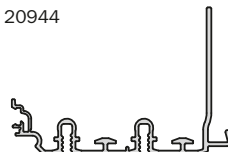

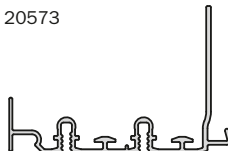

**PROFILI**





PROFILO SUPERIORE STANDARD		CODICE				FISSAGGIO	
	(mm)		(pz)	(kg)	(mm)		
Predisposto per copertura frontale	6200	VE41PIA16200AB	8	39,0	105 x 115 x 6300	<b>Klik</b> 	21152 
	3100	VE41PTA13100AB	8	19,6	105 x 115 x 3200	<b>Klik</b> 	
Non predisposto per copertura frontale	6200	VE41PIB16200AB	8	39,5	105 x 115 x 6300	<b>Klik</b> 	21151 
	3100	VE41PTB13100AB	8	19,8	105 x 115 x 3200	<b>Klik</b> 	

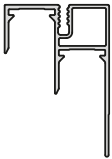







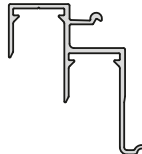

PROFILO SUPERIORE RINFORZATO		CODICE				FISSAGGIO	
	(mm)		(pz)	(kg)	(mm)		
Predisposto per copertura frontale	6200	VE41PIA26200AB	8	52,4	200 x 130 x 6300	<b>Klik</b> 	20944 
	3100	VE41PTA23100AB	8	26,2	200 x 130 x 3200	<b>Klik</b> 	
Non predisposto per copertura frontale	6200	VE41PIB26200AB	8	52,6	200 x 130 x 6300	<b>Klik</b> 	20573 
	3100	VE41PTB23100AB	8	26,3	200 x 130 x 3200	<b>Klik</b> 	









PROFILO INFERIORE		CODICE				FISSAGGIO	21162	
	(mm)		(pz)	(kg)	(mm)			
6200	VE41PIE16200AB	8	37,0	75 x 190 x 6300				
3100	VE41PTE13100AB	8	18,5	75 x 190 x 3200				

PROFILO INFERIORE		CODICE				FISSAGGIO	39428	
	(mm)		(pz)	(kg)	(mm)			
6200	VE41BIX06200AB	8	35,8	235 x 75 x 6300	<b>Klik</b>			
3100	VE41BTX03100AB	8	17,9	235 x 75 x 3200	<b>Klik</b>			





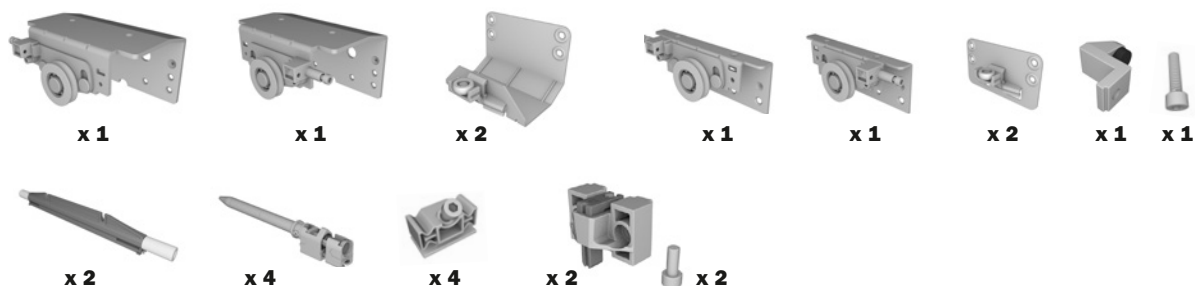

COPERTURA FRONTALE		CODICE				34032	
	(mm)		(pz)	(kg)	(mm)		
Con sede per spazzolino	6200	VE41BIA06200AB	8	15,7	125 x 75 x 6300		
	3100	VE41BTA03100AB	8	7,80	125 x 75 x 3200		
Senza sede per spazzolino	6200	VE41BIB06200AB	8	15,02	125 x 75 x 6300	35510	
	3100	VE41BTB03100AB	8	7,50	125 x 75 x 3200		

**2 ANTE AMMORTIZZATO (25 KG)**

ARTICOLO			CODICE				
	(mm)	(mm)		(pz)	(kg)	(m <sup>3</sup> )	(mm)
Carrelli e ammortizzatori per armadio a 2 ante	≤ 23	17	VE41KSKACMA2013	1	4,52	0,013	330 x 230 x 170
	≤ 23	33	VE41KSKACMA2513	1	4,54	0,013	330 x 230 x 170
	≤ 26	17	VE41KSKACMA2063	1	4,56	0,013	330 x 230 x 170
	≤ 26	33	VE41KSKACMA2563	1	4,57	0,013	330 x 230 x 170
	≤ 30	17	VE41KSKACMA2023	1	4,59	0,013	330 x 230 x 170
	≤ 30	33	VE41KSKACMA2523	1	4,61	0,013	330 x 230 x 170
	≤ 35	17	VE41KSKACMA2033	1	4,65	0,014	340 x 240 x 175
	≤ 35	33	VE41KSKACMA2533	1	4,67	0,014	340 x 240 x 175
	≤ 40	17	VE41KSKACMA2043	1	4,71	0,014	340 x 240 x 180
	≤ 40	33	VE41KSKACMA2543	1	4,73	0,014	340 x 240 x 180
	≤ 50	17	VE41KSKACMA2053	1	4,89	0,015	340 x 240 x 190
	≤ 50	33	VE41KSKACMA2553	1	4,91	0,015	340 x 240 x 190







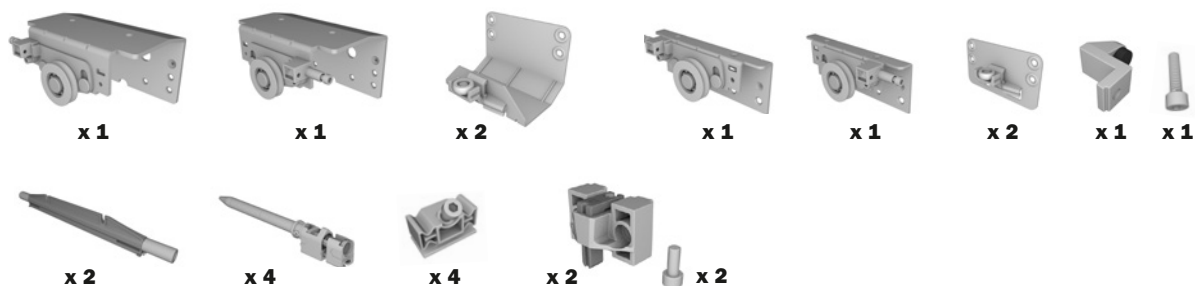

## 2 ANTE AMMORTIZZATO (45 KG)

ARTICOLO			CODICE				
	(mm)	(mm)		(pz)	(kg)	(m <sup>3</sup> )	(mm)
Carrelli e ammortizzatori per armadio a 2 ante	≤ 23	17	VE41KSKACMA2010	1	4,52	0,013	330 x 230 x 170
	≤ 23	33	VE41KSKACMA2510	1	4,54	0,013	330 x 230 x 170
	≤ 26	17	VE41KSKACMA2060	1	4,56	0,013	330 x 230 x 170
	≤ 26	33	VE41KSKACMA2560	1	4,57	0,013	330 x 230 x 170
	≤ 30	17	VE41KSKACMA2020	1	4,59	0,013	330 x 230 x 170
	≤ 30	33	VE41KSKACMA2520	1	4,61	0,013	330 x 230 x 170
	≤ 35	17	VE41KSKACMA2030	1	4,65	0,014	340 x 240 x 175
	≤ 35	33	VE41KSKACMA2530	1	4,67	0,014	340 x 240 x 175
	≤ 40	17	VE41KSKACMA2040	1	4,71	0,014	340 x 240 x 180
	≤ 40	33	VE41KSKACMA2540	1	4,73	0,014	340 x 240 x 180
	≤ 50	17	VE41KSKACMA2050	1	4,89	0,015	340 x 240 x 190
	≤ 50	33	VE41KSKACMA2550	1	4,91	0,015	340 x 240 x 190







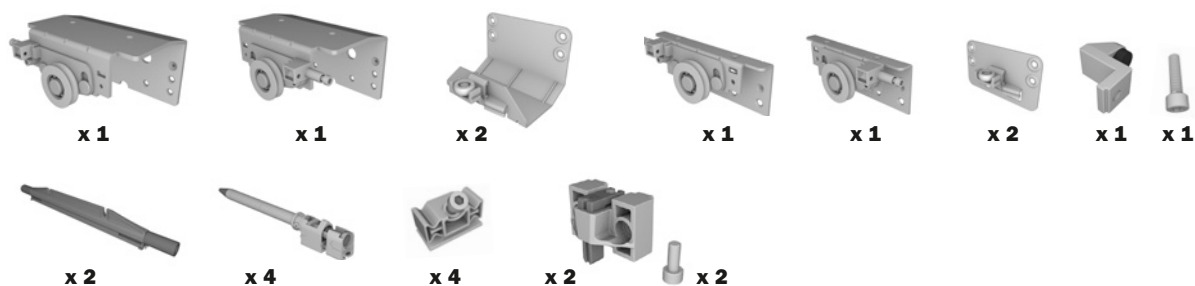

**2 ANTE AMMORTIZZATO (70 KG)**

ARTICOLO			CODICE				
	(mm)	(mm)		(pz)	(kg)	(m <sup>3</sup> )	(mm)
<b>Carrelli e ammortizzatori per armadio a 2 ante</b>	≤ 23	17	VE41KSKACMA2015	1	4,52	0,013	330 x 230 x 170
	≤ 23	33	VE41KSKACMA2515	1	4,54	0,013	330 x 230 x 170
	≤ 26	17	VE41KSKACMA2065	1	4,56	0,013	330 x 230 x 170
	≤ 26	33	VE41KSKACMA2565	1	4,57	0,013	330 x 230 x 170
	≤ 30	17	VE41KSKACMA2025	1	4,59	0,013	330 x 230 x 170
	≤ 30	33	VE41KSKACMA2525	1	4,61	0,013	330 x 230 x 170
	≤ 35	17	VE41KSKACMA2035	1	4,65	0,014	340 x 240 x 175
	≤ 35	33	VE41KSKACMA2535	1	4,67	0,014	340 x 240 x 175
	≤ 40	17	VE41KSKACMA2045	1	4,71	0,014	340 x 240 x 180
	≤ 40	33	VE41KSKACMA2545	1	4,73	0,014	340 x 240 x 180
	≤ 50	17	VE41KSKACMA2055	1	4,89	0,015	340 x 240 x 190
	≤ 50	33	VE41KSKACMA2555	1	4,91	0,015	340 x 240 x 190







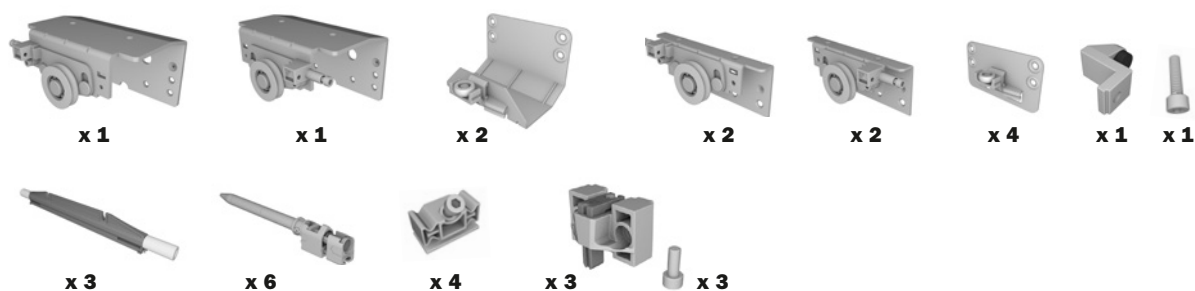

### 3 ANTE AMMORTIZZATO (25 KG)

ARTICOLO			CODICE				
	(mm)	(mm)		(pz)	(kg)	(m <sup>3</sup> )	(mm)
Carrelli e ammortizzatori per armadio a 3 ante	≤ 23	17	VE41KSKACMA3013	1	6,02	0,013	330 x 230 x 170
	≤ 23	33	VE41KSKACMA3513	1	6,06	0,013	330 x 230 x 170
	≤ 26	17	VE41KSKACMA3063	1	6,05	0,013	330 x 230 x 170
	≤ 26	33	VE41KSKACMA3563	1	6,08	0,013	330 x 230 x 170
	≤ 30	17	VE41KSKACMA3023	1	6,09	0,013	330 x 230 x 170
	≤ 30	33	VE41KSKACMA3523	1	6,13	0,013	330 x 230 x 170
	≤ 35	17	VE41KSKACMA3033	1	6,15	0,014	340 x 240 x 175
	≤ 35	33	VE41KSKACMA3533	1	6,19	0,014	340 x 240 x 175
	≤ 40	17	VE41KSKACMA3043	1	6,21	0,014	340 x 240 x 180
	≤ 40	33	VE41KSKACMA3543	1	6,25	0,014	340 x 240 x 180
	≤ 50	17	VE41KSKACMA3053	1	6,39	0,015	340 x 240 x 190
	≤ 50	33	VE41KSKACMA3553	1	6,43	0,015	340 x 240 x 190







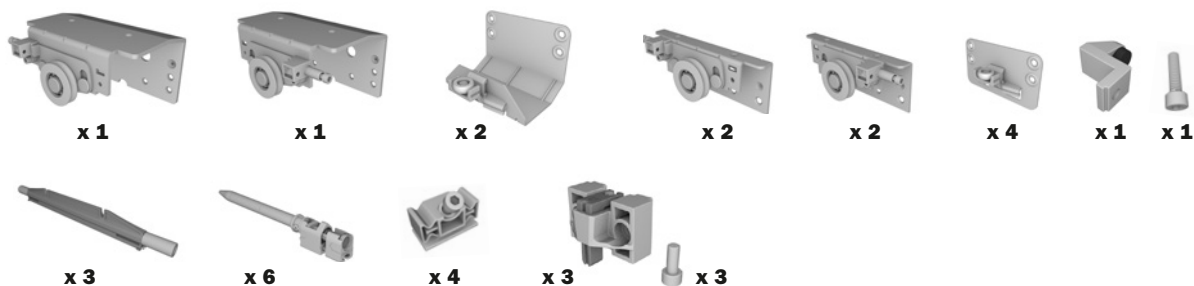

**3 ANTE AMMORTIZZATO (45 KG)**

ARTICOLO			CODICE				
	(mm)	(mm)		(pz)	(kg)	(m <sup>3</sup> )	(mm)
Carrelli e ammortizzatori per armadio a 3 ante	≤ 23	17	VE41KSKACMA3010	1	6,02	0,013	330 x 230 x 170
	≤ 23	33	VE41KSKACMA3510	1	6,06	0,013	330 x 230 x 170
	≤ 26	17	VE41KSKACMA3060	1	6,05	0,013	330 x 230 x 170
	≤ 26	33	VE41KSKACMA3560	1	6,08	0,013	330 x 230 x 170
	≤ 30	17	VE41KSKACMA3020	1	6,09	0,013	330 x 230 x 170
	≤ 30	33	VE41KSKACMA3520	1	6,13	0,013	330 x 230 x 170
	≤ 35	17	VE41KSKACMA3030	1	6,15	0,014	340 x 240 x 175
	≤ 35	33	VE41KSKACMA3530	1	6,19	0,014	340 x 240 x 175
	≤ 40	17	VE41KSKACMA3040	1	6,21	0,014	340 x 240 x 180
	≤ 40	33	VE41KSKACMA3540	1	6,25	0,014	340 x 240 x 180
	≤ 50	17	VE41KSKACMA3050	1	6,39	0,015	340 x 240 x 190
	≤ 50	33	VE41KSKACMA3550	1	6,43	0,015	340 x 240 x 190







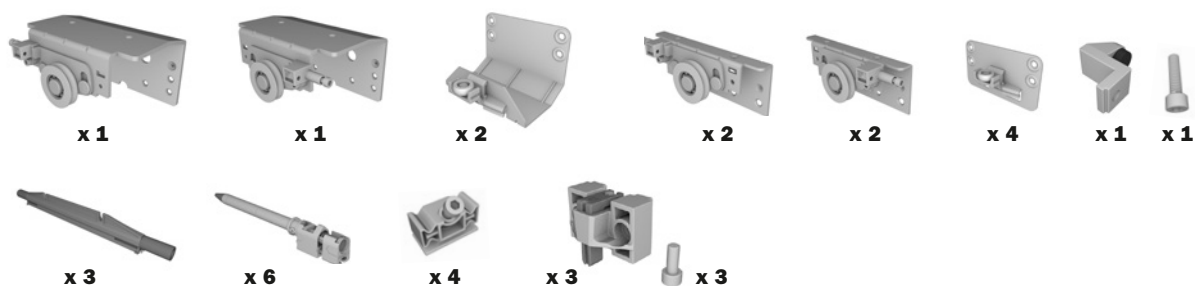

### 3 ANTE AMMORTIZZATO (70 KG)







ARTICOLO			CODICE				
	(mm)	(mm)		(pz)	(kg)	(m <sup>3</sup> )	(mm)
Carrelli e ammortizzatori per armadio a 3 ante	≤ 23	17	VE41KSKACMA3015	1	6,02	0,013	330 x 230 x 170
	≤ 23	33	VE41KSKACMA3515	1	6,06	0,013	330 x 230 x 170
	≤ 26	17	VE41KSKACMA3065	1	6,05	0,013	330 x 230 x 170
	≤ 26	33	VE41KSKACMA3565	1	6,08	0,013	330 x 230 x 170
	≤ 30	17	VE41KSKACMA3025	1	6,09	0,013	330 x 230 x 170
	≤ 30	33	VE41KSKACMA3525	1	6,13	0,013	330 x 230 x 170
	≤ 35	17	VE41KSKACMA3035	1	6,15	0,014	340 x 240 x 175
	≤ 35	33	VE41KSKACMA3535	1	6,19	0,014	340 x 240 x 175
	≤ 40	17	VE41KSKACMA3045	1	6,21	0,014	340 x 240 x 180
	≤ 40	33	VE41KSKACMA3545	1	6,25	0,014	340 x 240 x 180
	≤ 50	17	VE41KSKACMA3055	1	6,39	0,015	340 x 240 x 190
	≤ 50	33	VE41KSKACMA3555	1	6,43	0,015	340 x 240 x 190



**2 ANTE NON AMMORTIZZATO**

ARTICOLO			CODICE				
	(mm)	(mm)		(pz)	(kg)	(m <sup>3</sup> )	(mm)
Carrelli e arresti per armadio a 2 ante	≤ 23	17	VE41KSNACMI2010	1	3,86	0,009	330 x 230 x 120
	≤ 23	33	VE41KSNACMI2510	1	3,88	0,009	330 x 230 x 120
	≤ 26	17	VE41KSNACMI2060	1	3,89	0,009	330 x 230 x 120
	≤ 26	33	VE41KSNACMI2560	1	3,92	0,009	330 x 230 x 120
	≤ 30	17	VE41KSNACMI2020	1	3,93	0,009	330 x 230 x 120
	≤ 30	33	VE41KSNACMI2520	1	3,95	0,009	330 x 230 x 120
	≤ 35	17	VE41KSNACMI2030	1	3,99	0,010	340 x 240 x 125
	≤ 35	33	VE41KSNACMI2530	1	4,01	0,010	340 x 240 x 125
	≤ 40	17	VE41KSNACMI2040	1	4,05	0,011	340 x 240 x 130
	≤ 40	33	VE41KSNACMI2540	1	4,07	0,011	340 x 240 x 130
	≤ 50	17	VE41KSNACMI2050	1	4,23	0,011	340 x 240 x 140
	≤ 50	33	VE41KSNACMI2550	1	4,25	0,011	340 x 240 x 140

**3 ANTE NON AMMORTIZZATO**

ARTICOLO			CODICE				
	(mm)	(mm)		(pz)	(kg)	(m <sup>3</sup> )	(mm)
Carrelli e arresti per armadio a 3 ante	≤ 23	17	VE41KSNACMI3010	1	4,04	0,009	330 x 230 x 120
	≤ 23	33	VE41KSNACMI3510	1	4,24	0,009	330 x 230 x 120
	≤ 26	17	VE41KSNACMI3060	1	4,06	0,009	330 x 230 x 120
	≤ 26	33	VE41KSNACMI3560	1	4,28	0,009	330 x 230 x 120
	≤ 30	17	VE41KSNACMI3020	1	4,11	0,009	330 x 230 x 120
	≤ 30	33	VE41KSNACMI3520	1	4,31	0,009	330 x 230 x 120
	≤ 35	17	VE41KSNACMI3030	1	4,17	0,010	340 x 240 x 125
	≤ 35	33	VE41KSNACMI3530	1	4,37	0,010	340 x 240 x 125
	≤ 40	17	VE41KSNACMI3040	1	4,23	0,011	340 x 240 x 130
	≤ 40	33	VE41KSNACMI3540	1	4,43	0,011	340 x 240 x 130
	≤ 50	17	VE41KSNACMI3050	1	4,41	0,011	340 x 240 x 140
	≤ 50	33	VE41KSNACMI3550	1	4,61	0,011	340 x 240 x 140

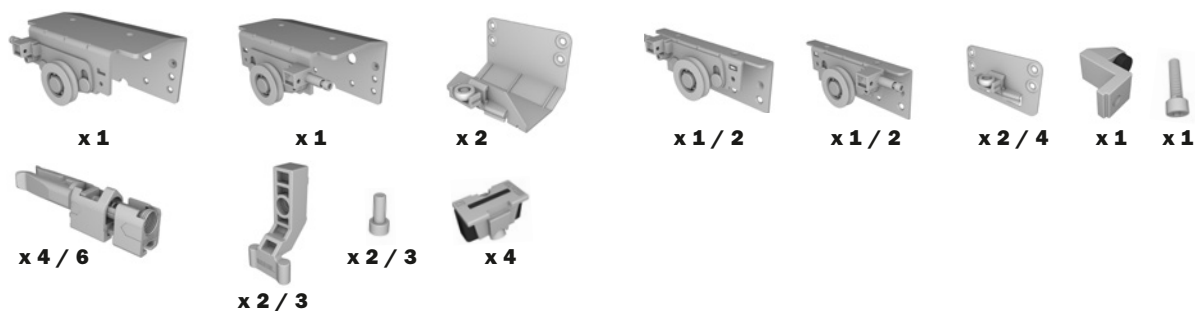



## KIT CARRELLI 100 KG

Coppia di carrelli, che aggiunti a quelli standard, aumentano la portata dell'anta fino ad un massimo di 100 kg.

ARTICOLO	CODICE	(pz)	(kg)	(m <sup>3</sup> )	(mm)
<b>Carrelli per anta interna</b>	<b>VE41KSKPCMI1A99</b>	<b>1</b>	<b>1,2</b>	<b>0,011</b>	<b>340 x 240 x 136</b>

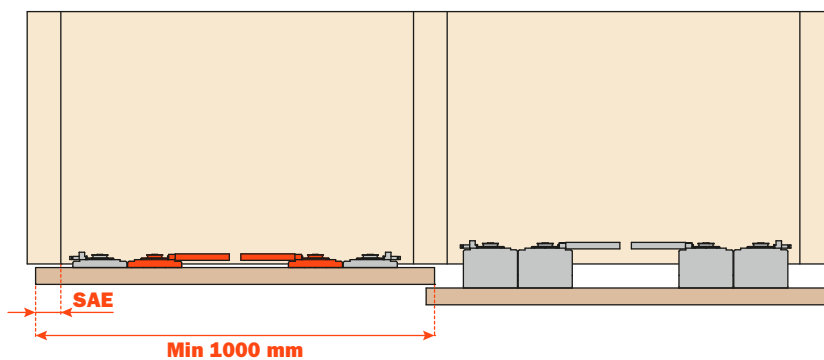
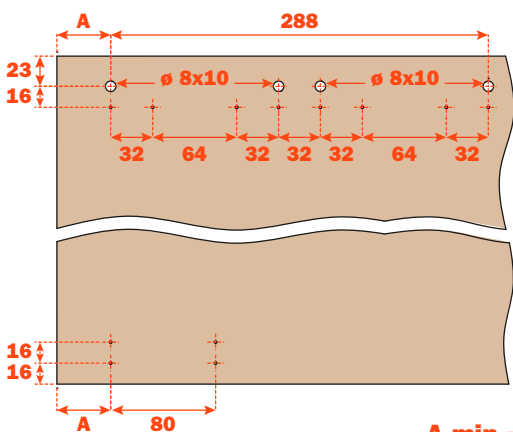
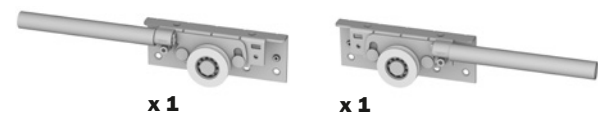

$$A \text{ min} = \text{SAE} + 41 \text{ mm}$$

ARTICOLO	(mm)	CODICE	(pz)	(kg)	(m <sup>3</sup> )	(mm)
<b>Carrelli per anta esterna</b>	23	VE41KSKPCMI1A19	1	2,2	0,011	340 x 240 x 136
	26	VE41KSKPCMI1A69	1	2,3	0,011	340 x 240 x 136
	30	VE41KSKPCMI1A29	1	2,3	0,011	340 x 240 x 136
	35	VE41KSKPCMI1A39	1	2,4	0,011	340 x 240 x 136
	40	VE41KSKPCMI1A49	1	2,5	0,011	340 x 240 x 136
	50	VE41KSKPCMI1A59	1	2,6	0,011	340 x 240 x 136

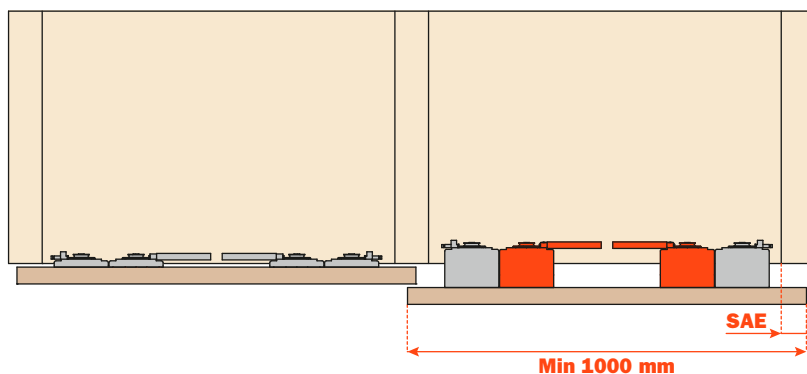
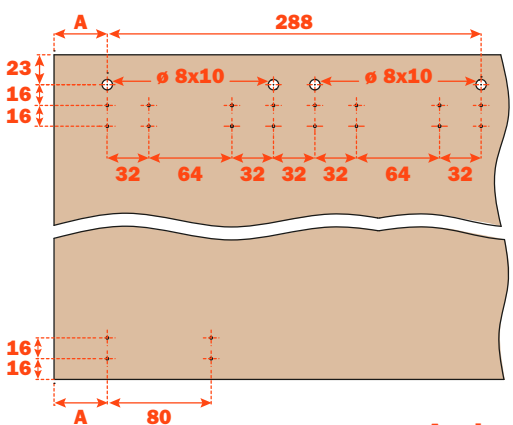
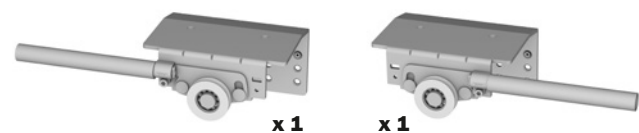

$$A \text{ min} = \text{SAE} + 41 \text{ mm}$$

**KIT ACCESSORI PER COPERTURA FRONTALE**

ARTICOLO	L (mm)	CODICE	(pz)	(kg)	(m <sup>3</sup> )	(mm)
Kit magneti, contropiastre e spazzolino	≤ 2000	VE41KSM0S05	1	0,10	-	120 x 80 x 4
	≤ 3000	VE41KSM0S06	1	0,12	-	120 x 80 x 4
	≤ 4000	VE41KSM0S07	1	0,14	-	120 x 80 x 4



x 5 / 6 / 8



x 5 / 6 / 8



x 2 / 3 / 4

**KIT CLIP**

ARTICOLO	CODICE	(pz)	(kg)	(m <sup>3</sup> )	(mm)
Kit 6 agganci con applicatore	VE41KSCLIP6	1	0,26	-	-
Kit 9 agganci con applicatore	VE41KSCLIP9	1	0,37	-	-



x 6/9



x 6/9



x 6/9





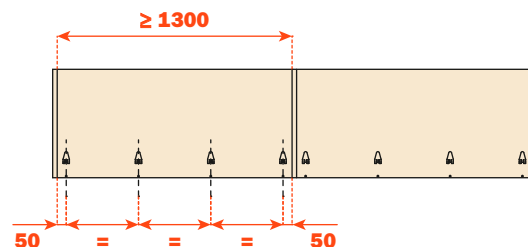
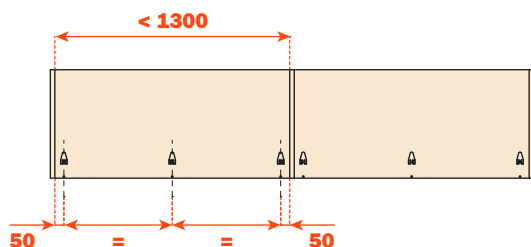

x 1

**Klik**



## KIT PERNI ANTICOLLISIONE



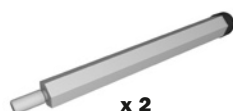

Per gli armadi a 3 ante, è possibile ordinare i perni anticollisione da applicare alle ante interne (1 kit da 2 pezzi).

ARTICOLO	CODICE	 (pz)	 (kg)	 (m <sup>3</sup> )	 (mm)
<b>Perni anticollisione</b>	<b>VE41KMGLW510C</b>	<b>1</b>	<b>0,05</b>	<b>-</b>	<b>-</b>



x 2

## CARTER PARAPOLVERE CON VELCRO AUTOADESIVO

ARTICOLO	L	CODICE	 (pz)	 (kg)	 (m <sup>3</sup> )	 (mm)
	(mm)					
<b>Carter copri staffe anta esterna</b>	600	VE41CSVS00600A	1	0,31	0,003	900 x 110 x 30
	700	VE41CSVS00700A	1	0,33	0,003	900 x 110 x 30
	800	VE41CSVS00800A	1	0,35	0,003	900 x 110 x 30
	900	VE41CSVS00900A	1	0,38	0,003	900 x 110 x 30
	1000	VE41CSVS01000A	1	0,45	0,004	1200 x 110 x 30
	1100	VE41CSVS01100A	1	0,48	0,004	1200 x 110 x 30
	1200	VE41CSVS01200A	1	0,50	0,004	1200 x 110 x 30
	1300	VE41CSVS01300A	1	0,52	0,005	1500 x 110 x 30
	1400	VE41CSVS01400A	1	0,55	0,005	1500 x 110 x 30
	1500	VE41CSVS01500A	1	0,63	0,006	1500 x 110 x 30
	1600	VE41CSVS01600A	1	0,66	0,006	2000 x 110 x 30
	1700	VE41CSVS01700A	1	0,68	0,006	2000 x 110 x 30
	1800	VE41CSVS01800A	1	0,70	0,006	2000 x 110 x 30
1900	VE41CSVS01900A	1	0,72	0,006	2000 x 110 x 30	
2000	VE41CSVS02000A	1	0,85	0,006	2000 x 110 x 30	

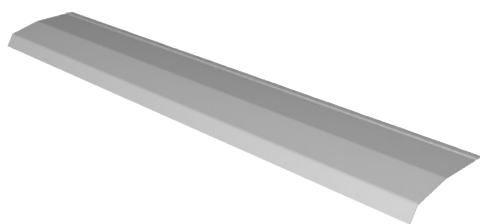

**ESEMPI COMPOSIZIONE CODICE****Esempio 1**

Armadio 2 ante (70 kg) da 900 mm, spessore 30 mm, H da terra 17 mm, profilo standard, ammortizzatore, copertura frontale con spazzolino, profili di lunghezza 3100 mm.

<b>1 x VE41PTA13100AB</b>	<b>1 x VE41KSM0S05</b>
<b>1 x VE41PTE13100AB</b>	<b>1 x VE41CSVS00900A</b>
<b>1 x VE41BTA03100AB</b>	<b>1 x VE41KSKACMA2025</b>

**Esempio 2**

Armadio 3 ante (45 kg) da 1200 mm, spessore 35 mm, H da terra 33 mm, profilo rinforzato, ammortizzatore, copertura frontale con spazzolino, profili di lunghezza 6200 mm.

<b>1 x VE41PIA26200AB</b>	<b>1 x VE41KSM0S07</b>
<b>1 x VE41PIE16200AB</b>	<b>1 x VE41CSVS01200A</b>
<b>1 x VE41BIA06200AB</b>	<b>1 x VE41KSKACMA3530</b>

**Esempio 3**

Armadio 3 ante da 1200 mm, spessore 50 mm, H da terra 33 mm, profilo standard, senza ammortizzatore e copertura frontale senza spazzolino, profili di lunghezza 6200 mm.

<b>1 x VE41PIA16200AB</b>	<b>1 x VE41KSM0S07</b>
<b>1 x VE41BIA06200AB</b>	<b>1 x VE41CSVS01200A</b>
<b>1 x VE41BIB06200AB</b>	<b>1 x VE41KSNACMI3550</b>

Negli esempi sono indicate le quantità necessarie per un armadio; per i quantitativi minimi di acquisto si rinvia alle tabelle precedenti.

ANTE INTERNE

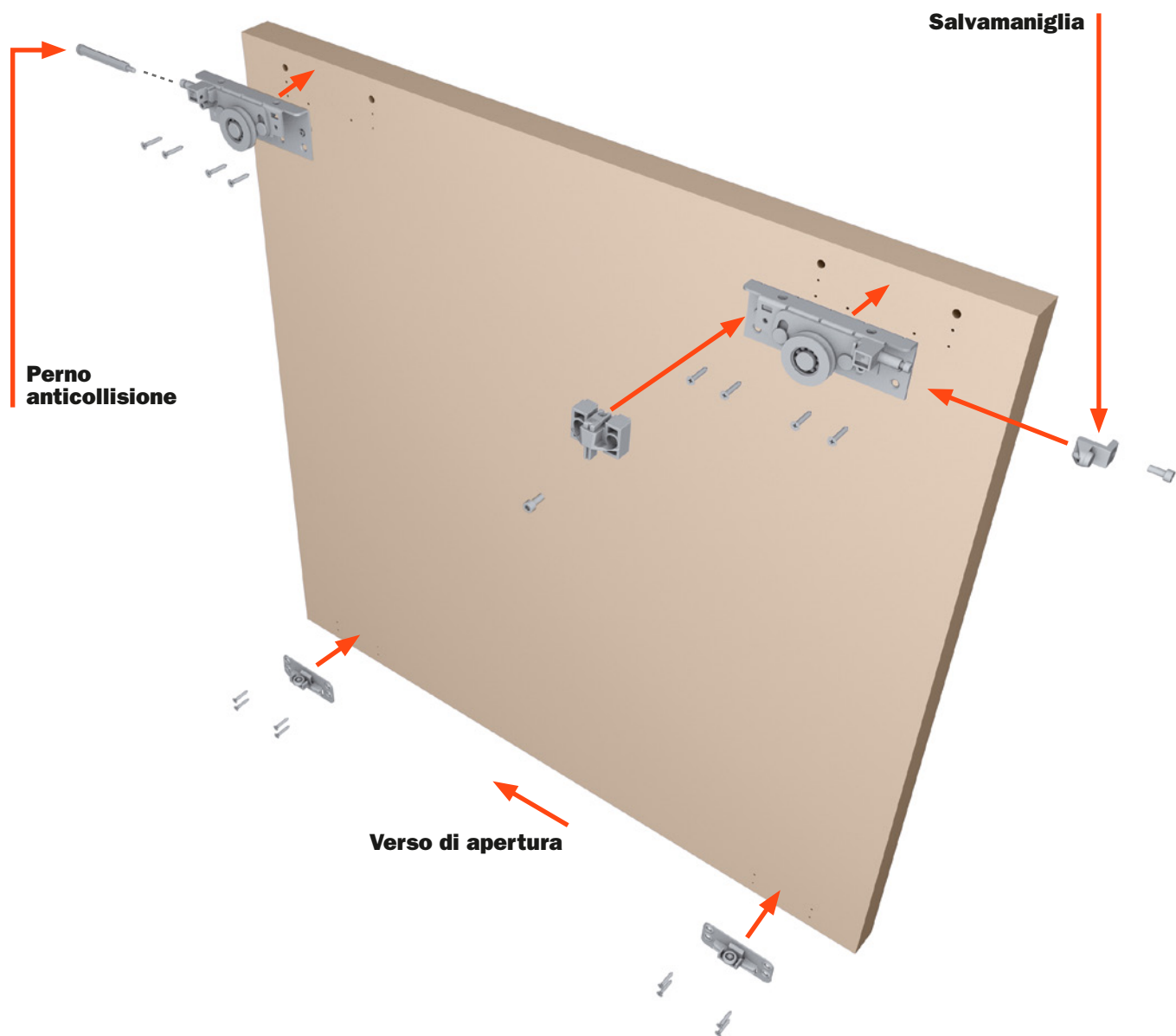

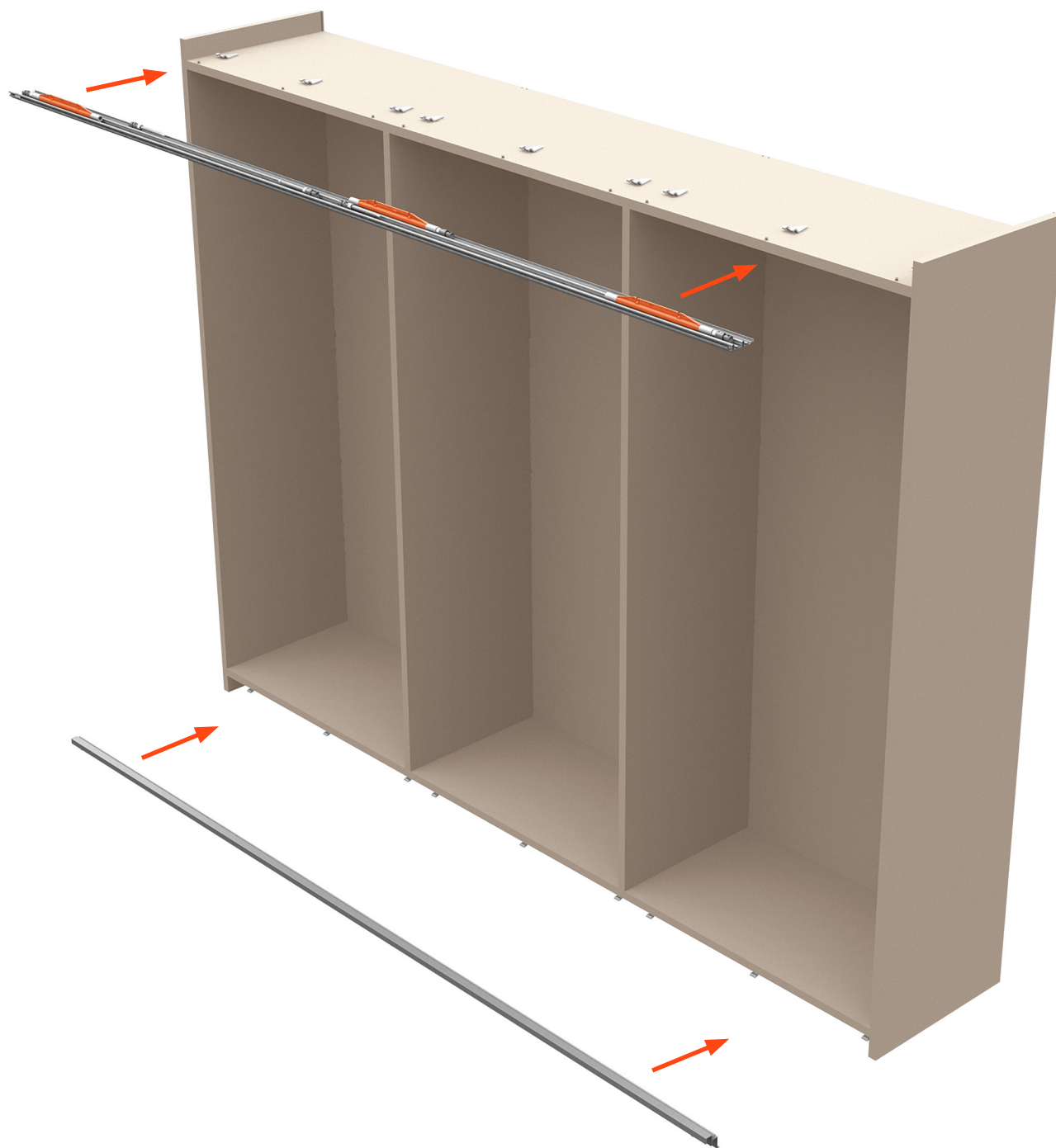

---

## **BREVETTI**

Brevetto depositato presso il Ministero delle Attività Produttive Ufficio Italiano Brevetti e Marchi (U.I.B.M.).



## **ARTURO SALICE S.p.A.**

VIA PROVINCIALE NOVEDRATESE, 10  
22060 NOVEDRATE (COMO) ITALIA  
TEL. 031 790424  
FAX 031 791508  
info.salice@salice.com  
www.salice.com

## **BORTOLUZZI SISTEMI S.p.A.**

VIA CADUTI 14 SETTEMBRE 1944, 45  
32100 BELLUNO ITALIA  
TEL. 0437 930866  
FAX 0437 931442  
info@bortoluzzi.com  
www.bortoluzzi.com

## **DEUTSCHE SALICE GMBH**

RUDOLF DIESEL STR. 10  
POSTFACH 1154  
74382 NECKARWESTHEIM  
TEL. 07233 9807-0  
FAX. 07233 9807-16  
info.salice@deutschesalice.de  
www.deutschesalice.de

## **SALICE UK LTD.**

KINGFISHER WAY  
HINCHINGBROOKE BUSINESS PARK  
HUNTINGDON CAMBS PE 29 6FN  
TEL. 01480 413831  
FAX. 01480 451489  
info.salice@saliceuk.co.uk  
www.saliceuk.co.uk

## **DEUTSCHE SALICE GMBH**

VERKAUFSBÜRO NORD  
RINGSTRASSE 36/A30 CENTER  
32584 LÖHNE  
TEL. 05731 15608-0  
FAX. 05731 15608-10  
vknord@deutschesalice.de  
www.deutschesalice.de

## **SALICE AMERICA INC.**

2123 CROWN CENTRE DRIVE  
CHARLOTTE NC. 28227  
TEL. 704 8417810  
FAX. 704 8417808  
info.salice@saliceamerica.com  
www.saliceamerica.com

## **SALICE FRANCE S.A.R.L.**

ROUTE DE GOA ZAC LES 3 MOULINS  
06600 ANTIBES  
TEL. 0493 330069  
FAX. 0493 330141  
info.salice@salicefrance.com  
www.salicefrance.com

## **SALICE CANADA INC.**

3500 RIDGEWAY DRIVE,  
UNIT#1  
MISSISSAUGA, ONTARIO, L5L 0B4  
TEL. 905 8208787  
FAX. 905 8207226  
info.salice@salicecanada.com  
www.salicecanada.com

## **SALICE ESPAÑA, S.L.U.**

CALLE COPÉRNICO, 11  
POLÍGONO INDUSTRIAL  
COLL DE LA MANYA  
08403 GRANOLLERS (BARCELONA)  
TEL. 938 45 88 61  
FAX 938 49 11 97  
info.salice@saliceespana.es  
www.saliceespana.es

## **SALICE CHINA (SHANGHAI) CO. LTD.**

1st FLOOR, B1 BLDG 928 MINGZHU ROAD  
XUJING, QINGPU DISTRICT  
SHANGHAI 201702 - CHINA  
Tel. 021 3988 9880  
Fax 021 3988 9882  
info.salice@salicechina.com  
www.salicechina.com



### **Contenuti digitali:**

- Pdf prospetto tecnico

**Ci riserviamo il diritto di modificare le specifiche tecniche.**

DOCASS004ITA  
Ed. 02 - 03/2019

