

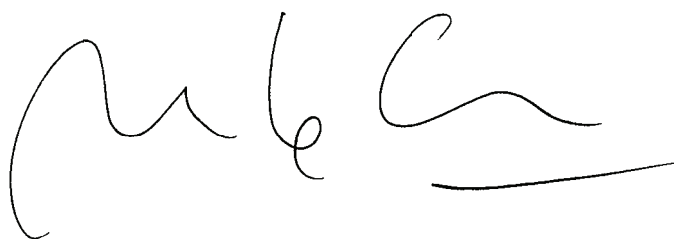

Antonio Citterio

Il mio lavoro sulle maniglie consiste nel ridisegnare modelli classici studiando piccoli dettagli e nuove proporzioni che ne diventano l'elemento caratterizzante.

My work on handles involves the redesign of classic models studying the small details and new proportions which then become the characteristic elements.





Fusital

H 361

Serie AC 4 Duemilasei design Antonio Citterio con Toan Nguyen

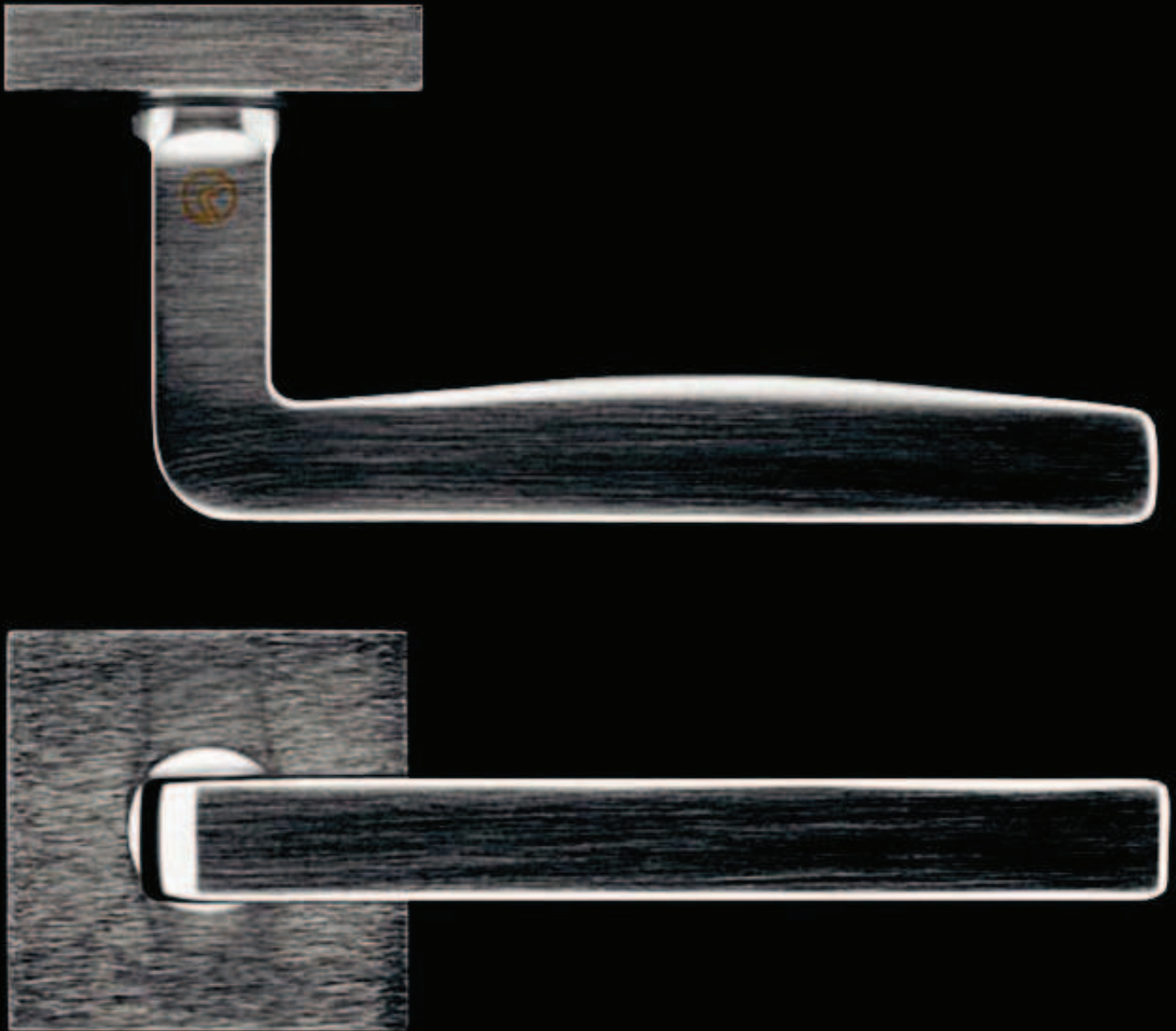

H 361

Serie AC 4 Duemilasei design Antonio Citterio con Toan Nguyen



Materiale
Nikrall lega Zama
UNI 3717

Material
Nikrall lega Zama
UNI 3717

H 361

Maniglia per porta
Door handle

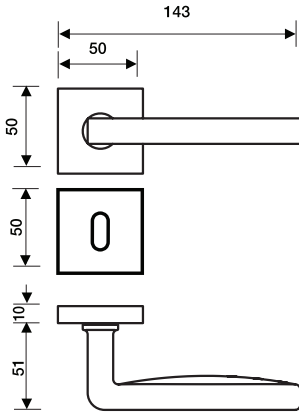

Cromsatin
Satin chrome



Cromo
Chrome

H 361 R7 - H 353 R8

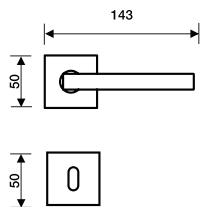

H 361 R7 Y - H 353 R8 Y

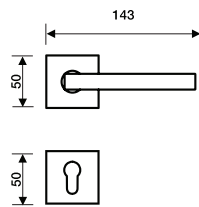

H 361 RG8/8.5

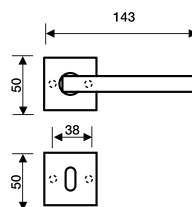

H 361 RG8/8.5 Y

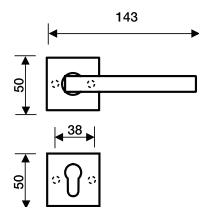

H 361 RG6 - 7 - 8 BZG

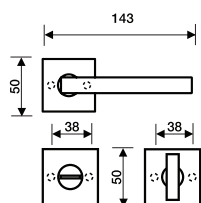

H 361 RQ Privacy

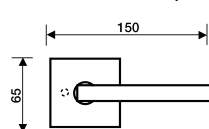

H 361 RQ Passage

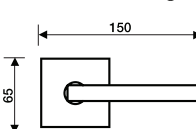

H 361 R SB

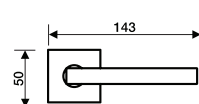

Materiale
Nikrall Lega Zama
UNI 3717

Material
Nikrall Lega Zama
Uni 3717

Finitura
Cromsatin
Cromo

Finish
Satin chrome
Chrome



H 361 F

Maniglia per finestra
Window handle

Movimenti
Movements

Gratz
Gratz CP
Gratz/7
Martellina

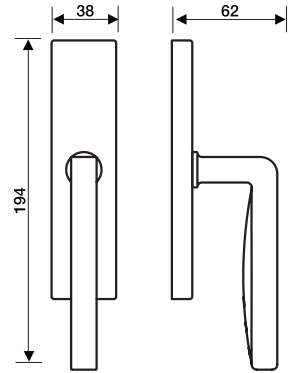

H 361 F RS

Maniglia per finestra
Window handle

Movimento
4 scatti

Movement
4 click positions

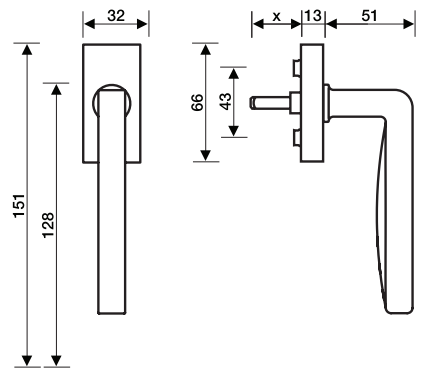

H 361 F SER

Maniglia per finestra
Window handle

Movimento
4 scatti con chiave

Movement
4 click positions with
key

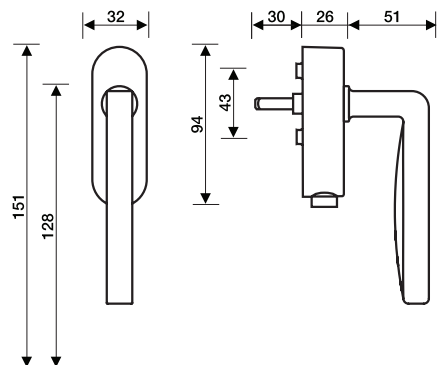

Materiale
Nikrall Lega Zama
UNI 3717

Material
Nikrall Lega Zama
Uni 3717

Finitura
Cromsatin
Cromo

Finish
Satin chrome
Chrome

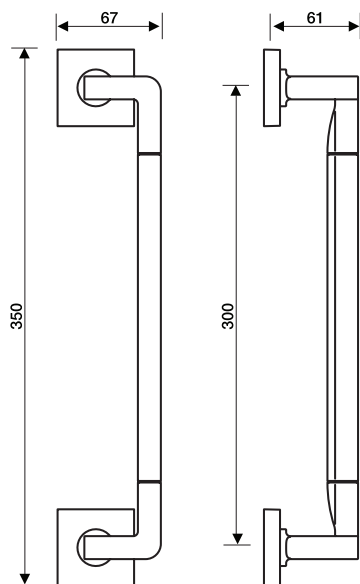

K 368
Maniglione
Pull handle

Interasse
Centre distance

300 mm

Materiale
Ottone

Material
Brass

Dispositivi di fissaggio da ordinare a parte
Fixings to be ordered separately

pag. 371/372/373

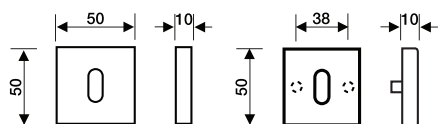
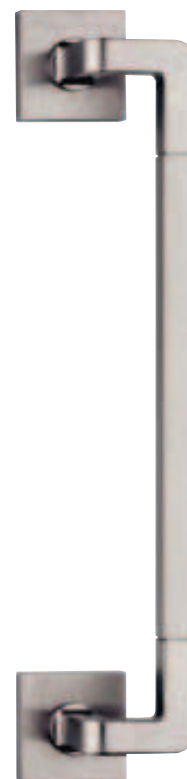

K 3019 - K 3720
Bocchetta foro normale
Standard hole escutcheon

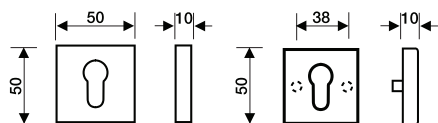

K 3019 Y - K 3720 Y
Bocchetta foro cilindro
Euro-profile hole escutcheon

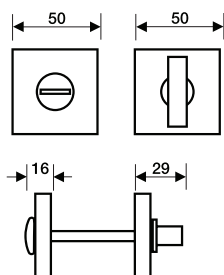

K 3020
Chiusura privacy BZG
Bathroom privacy set



K 3020 R6 - 7 - 8 BZG

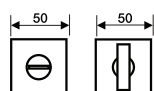

K 3020 RS6 - 7 - 8 BZG

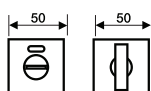

K 3020 RG6 - 7 - 8 BZG

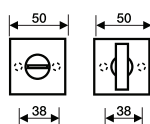

K 3020 RGS6 - 7 - 8 BZG

