

Rif./Ref.	Articolo / Article
A	6010.702
B	6010.B/860/1200/1500
C	6010.720/.721
D	6010.730

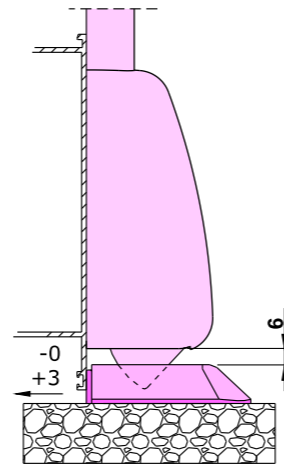

89011372 - REV. 0 - 125093 STAMPATO SU CARTA ECOLOGICA

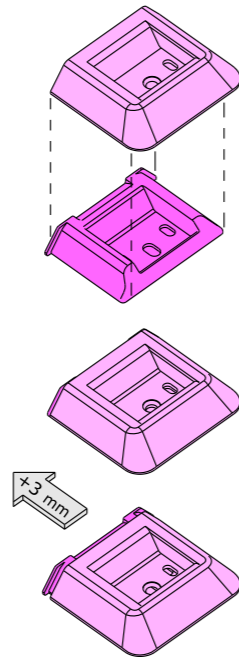

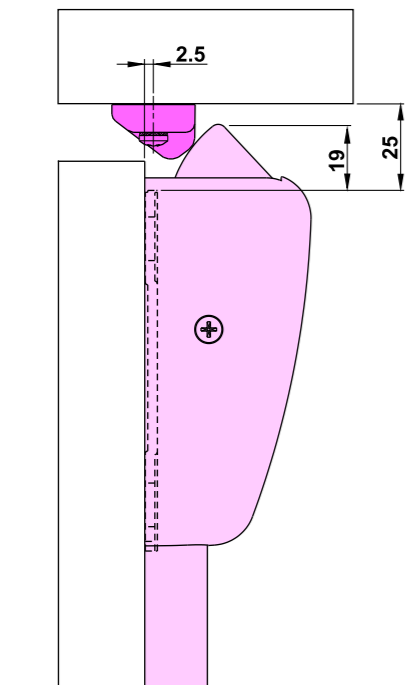
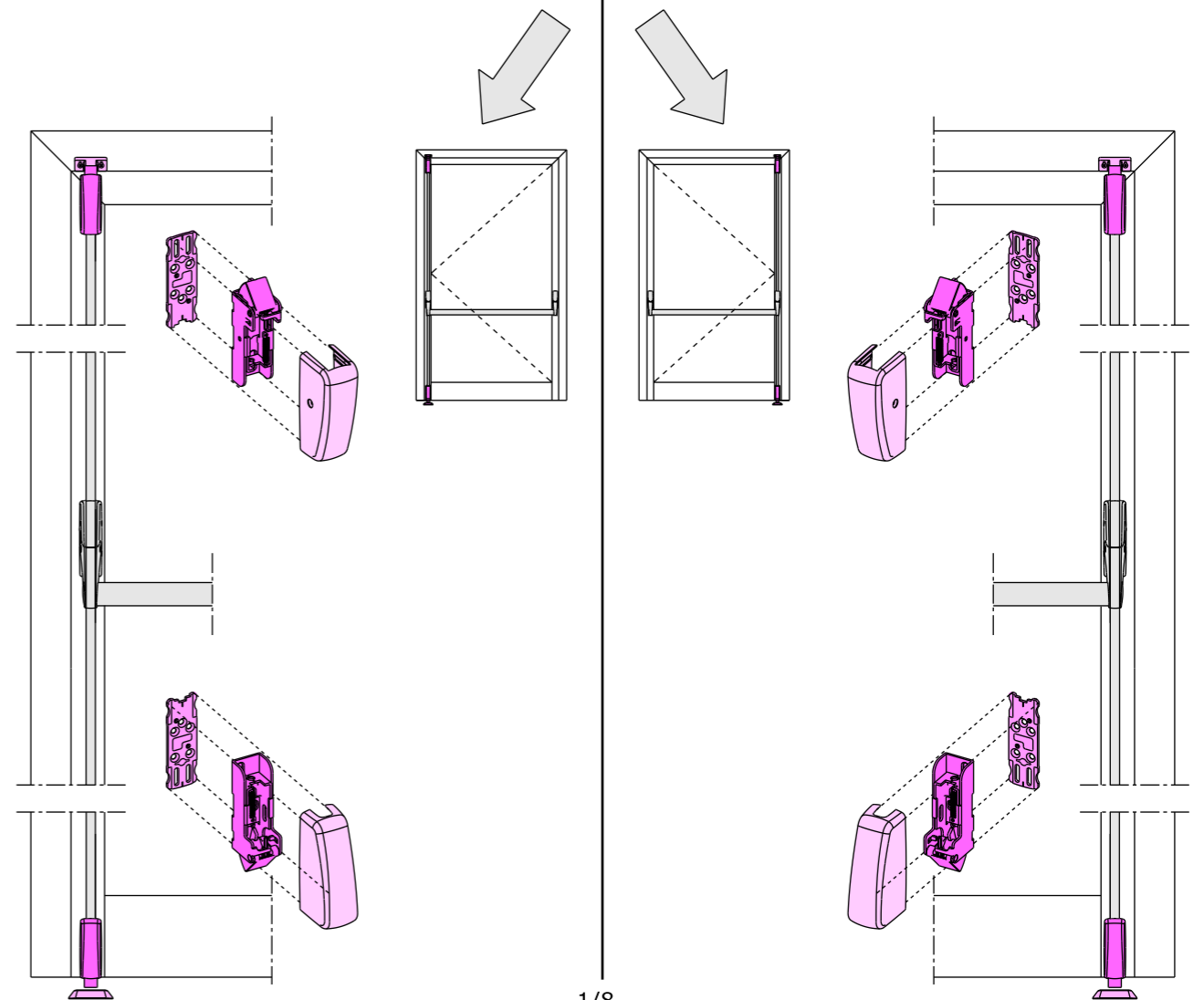

\* Per quote posizionamento contattare: assistenza@savio.it  
 For positioning dimensions, please contact: assistenza@savio.it  
 Pour le positionnement, svp contacter: assistance@savio.it  
 Para emplazar correctamente, contactar: asistencia@savio.it  
 Für Positionierungsmaß bitte in Verbindung mit: assistenza@savio.it setzen  
 Po szczegółowe pozycjonowanie: asistencia@savio.it  
 Для получения размеров установки, пожалуйста, напишите: assistenza@savio.it

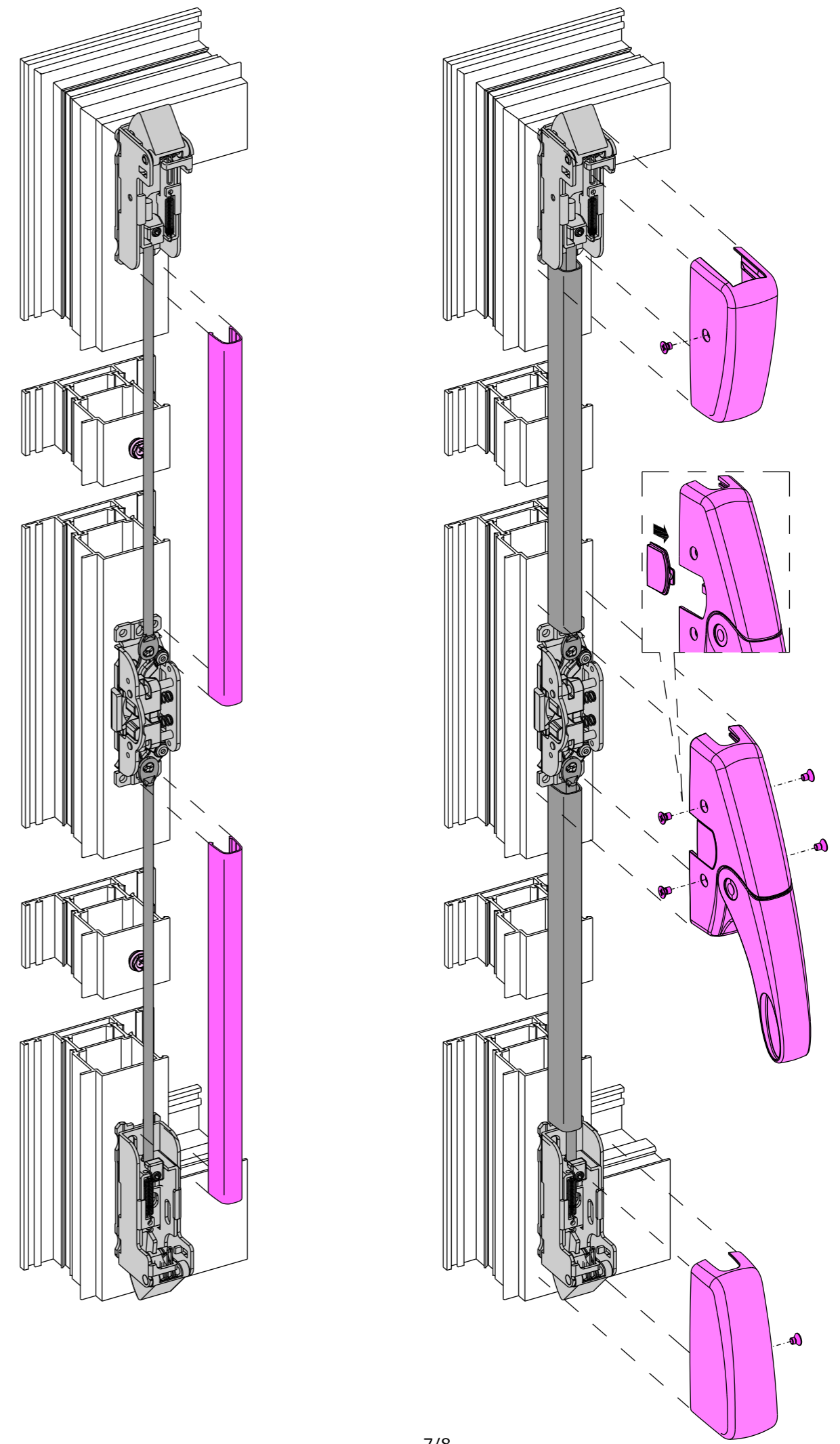
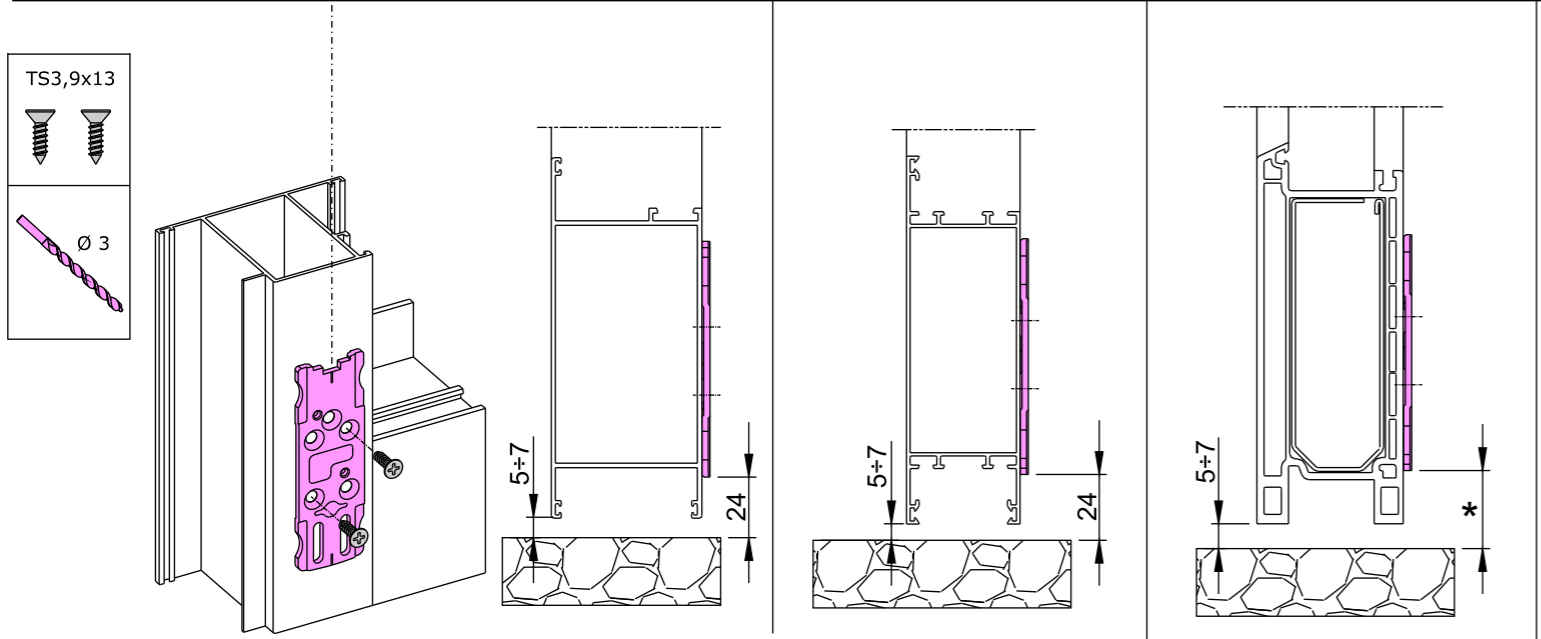
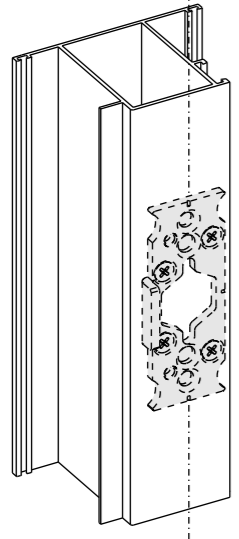

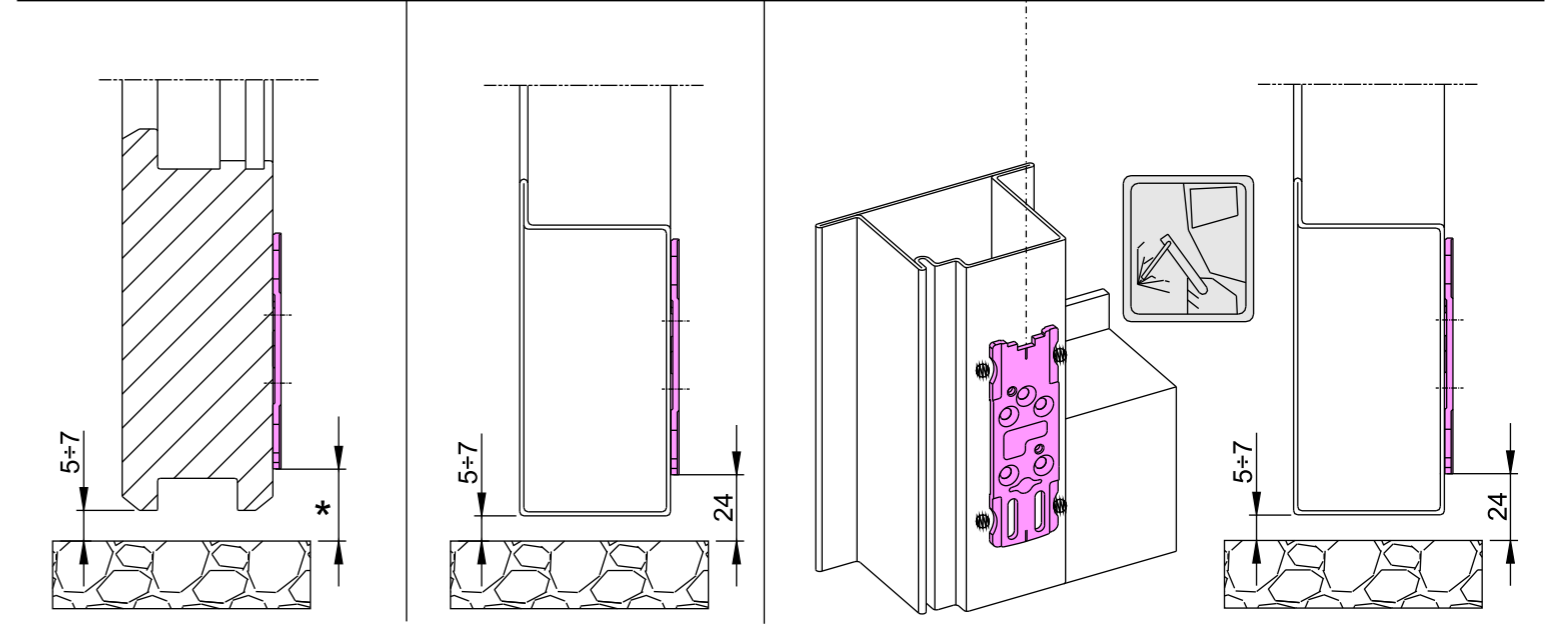
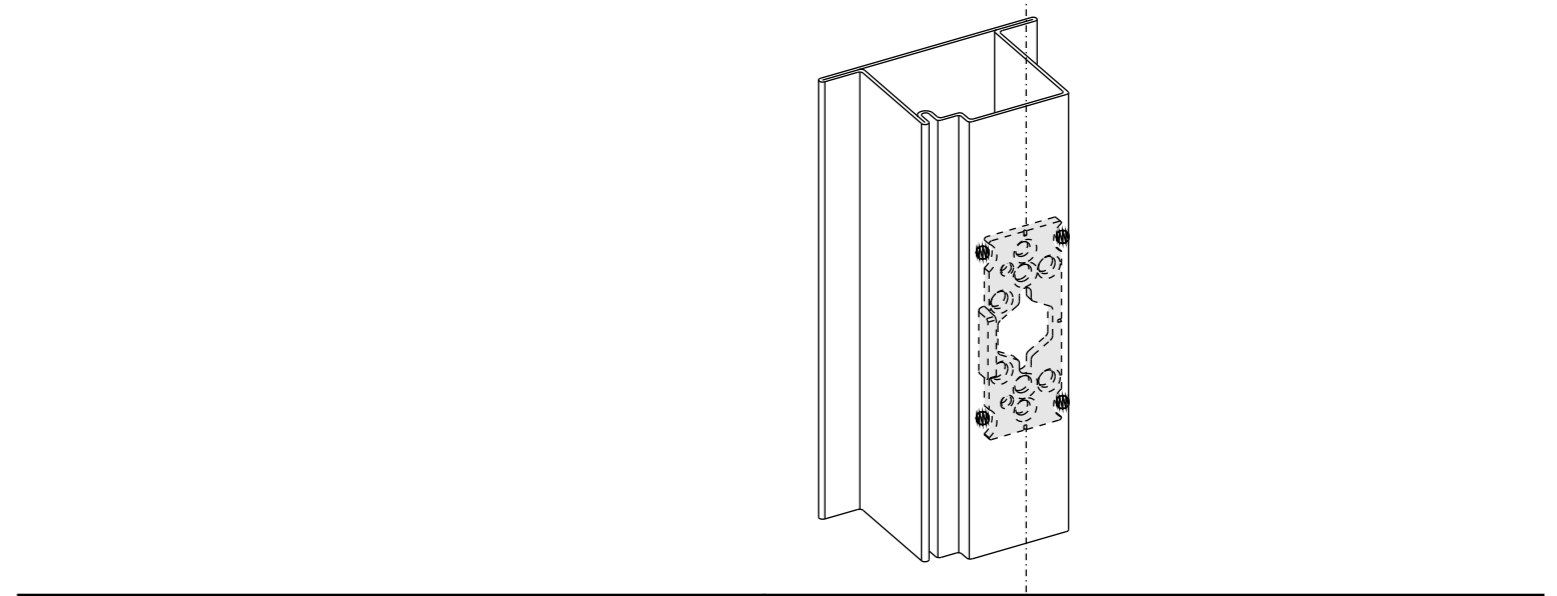
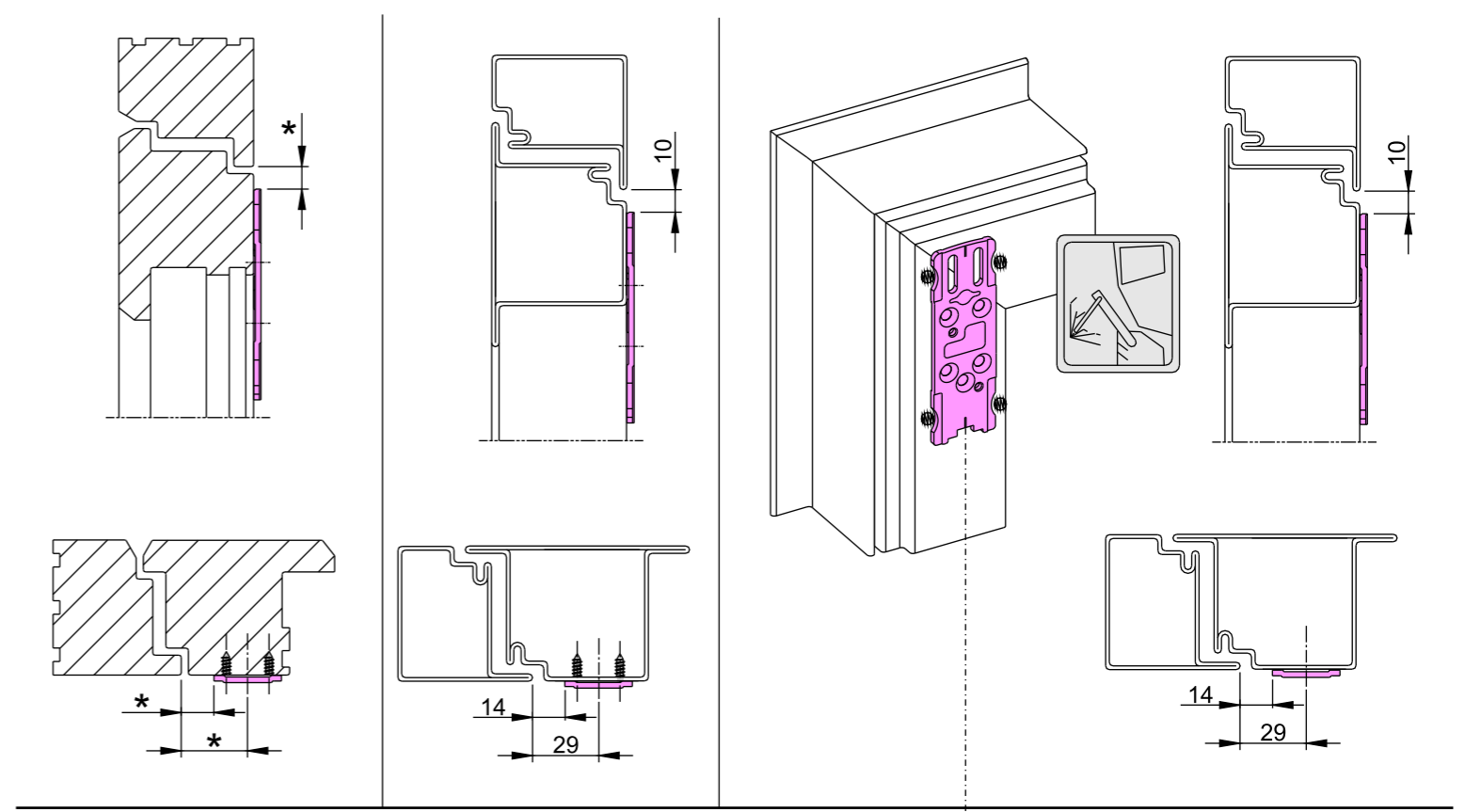
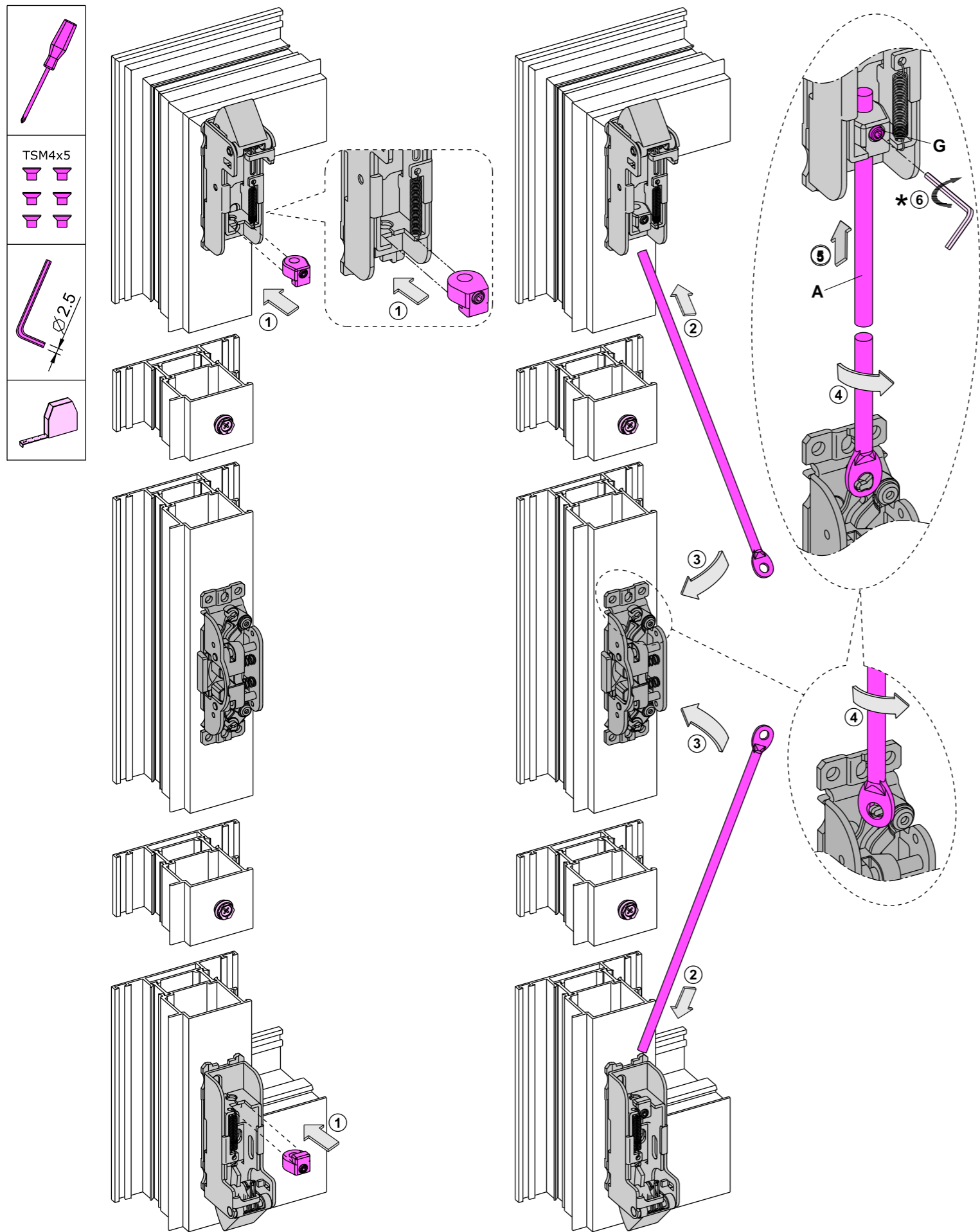

\* N.B.: Prima di serrare il grano **G** portare in tensione i carrelli del meccanismo principale agendo sull'astina **A** (come indicato al punto 5).  
 Note: Avant de serrer la vis-pointeau **G**, amener en tension les chariots du mécanisme principal en utilisant la tringle **A** (comme indiqué au point 5).  
 Note: Before tightening the grub-screw **G** stretch the rollers of the main mechanism acting on the rod **A**, as specified in the point 5.  
 Nota: Antes de apretar el prisionero **G**, traer en tensión los carros del mecanismo principal actuando sobre la pletina **A** (como indicado por el punto 5).  
 Bitte beachten: Vor dem anziehen der Madenschraube (**G**) ziehen sie die Rollen des Hauptmechanismus, der an der Schubstange arbeitet (**A**), auseinander.  
 Siehe Beschreibung Punkt 5.  
 Zauważ: Przed dokręceniem kołka **G**, naprężyc rolki głównego mechanizmu, działając na drążek **A** (jak pokazano w punkcie 5).  
 Примечание: Прежде чем затягивать винт (**G**) приведите в напряжение ролики основного механизма, воздействуя на тягу (**A**), как показано на позиции 5.

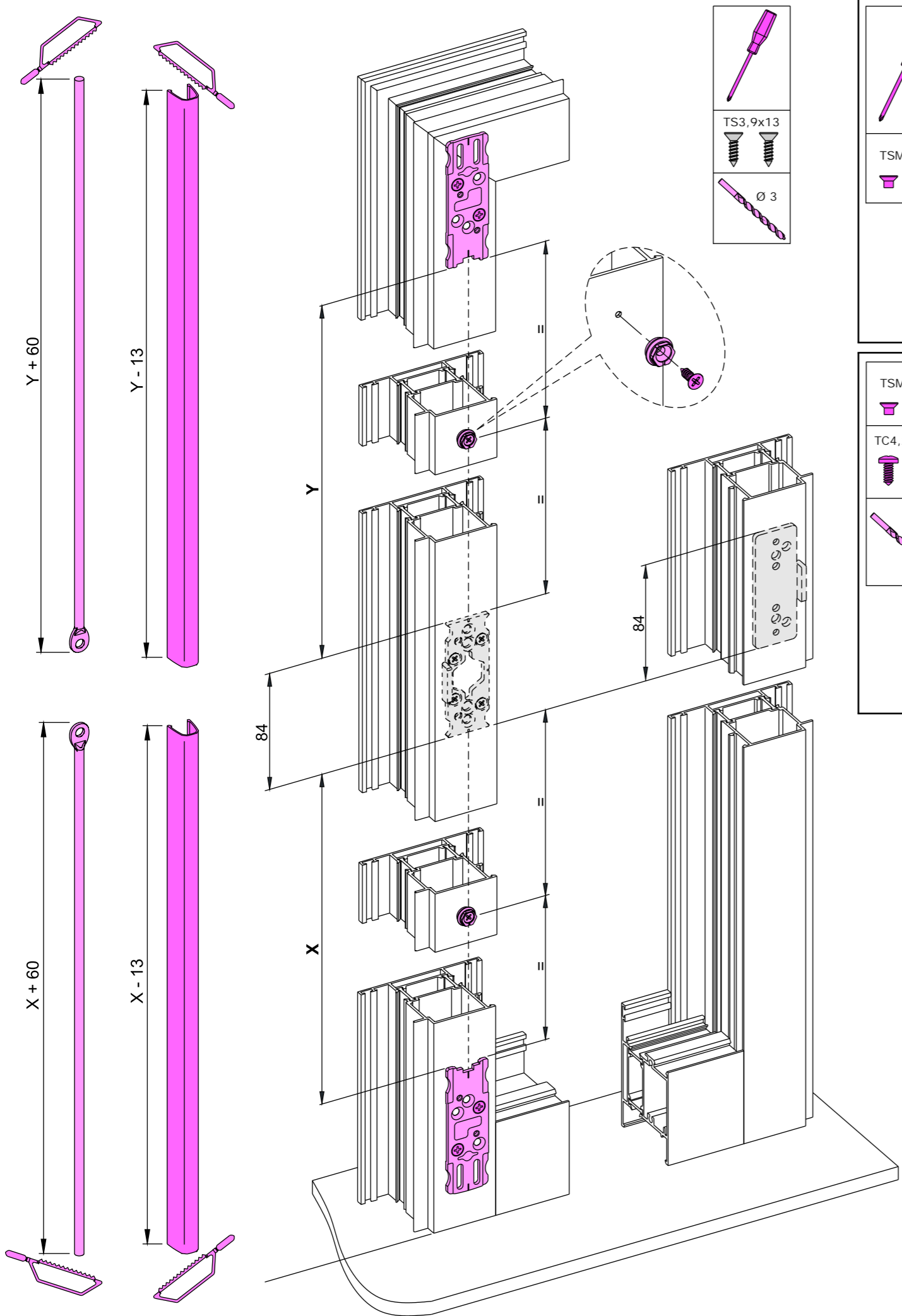

- TS3,9x13
- 
- Ø 3

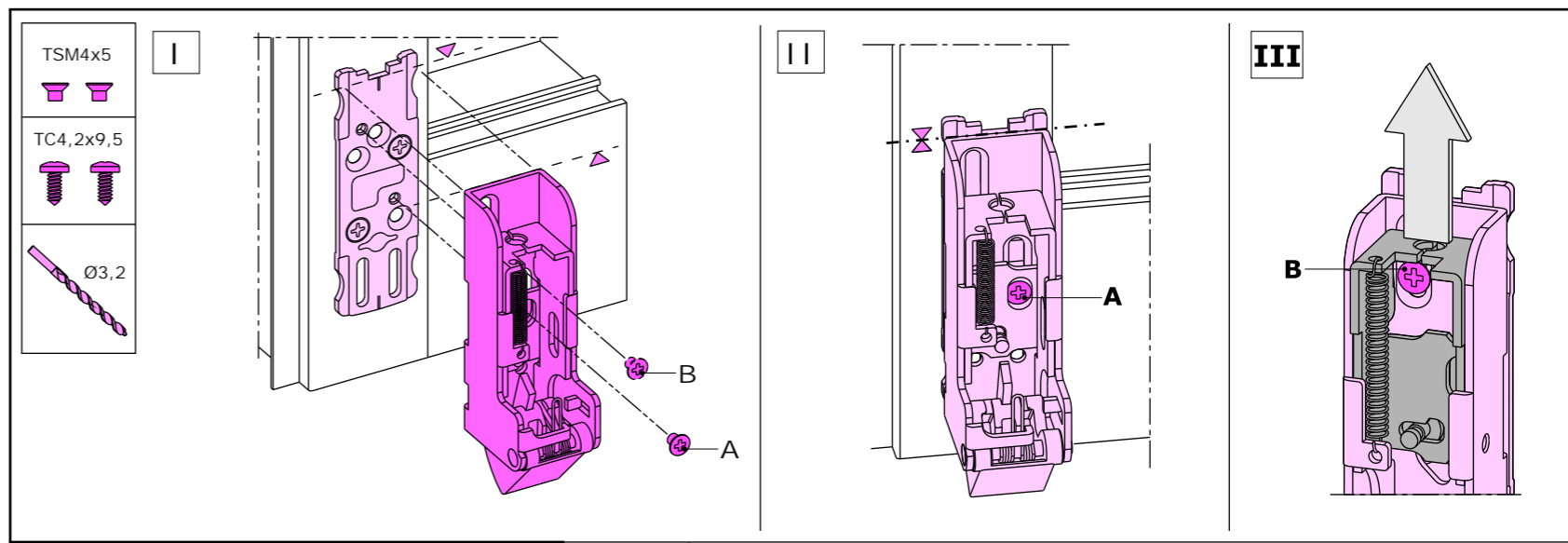
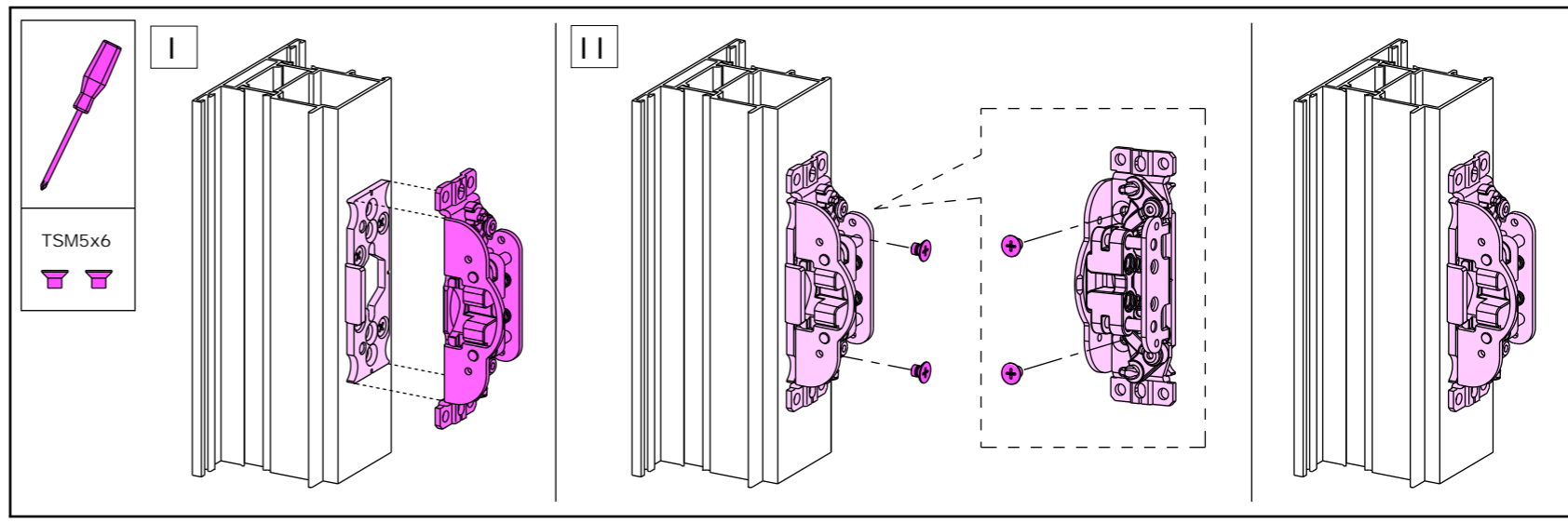

- TSM4x5
- TC4,2x9,5
- Ø3,2

