

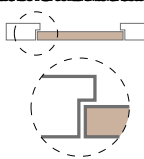

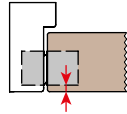

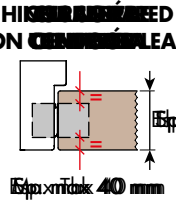
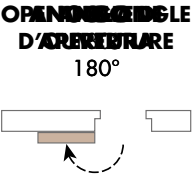
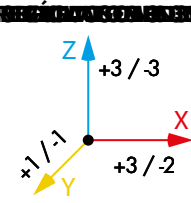
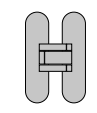

KUBICA K6700

PATENTED

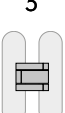

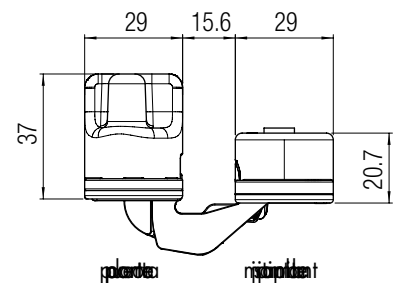
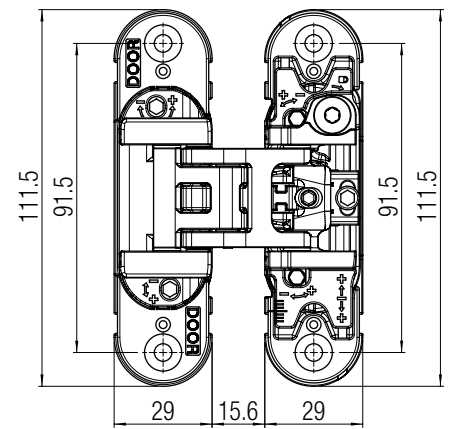

<p>INDICAZIONE</p> <p>Zanook</p>	<p>LOAD CAPACITY</p> <p>50 kg (110 lb) 70 kg (154 lb)</p> 	<p>APPLICAZIONE</p> <p>For use on sliding doors</p> 	<p>MEASURE</p>  <p>K-max 5.5 mm</p>
<p>HINGE MOUNTED ON OPENING LEAF</p>  <p>Max. thickness 40 mm</p>	<p>OPENING ANGLE D'APERTURE</p> <p>180°</p> 	<p>INSTALLATION</p>  <p>Z +3 / -3 X +3 / -2 Y x1 / -1</p>	
<p>FINISHING</p> <p>Full HD</p> 	<p>COVER MATERIAL</p> <p>Aluminium</p>  <p>KK (Krona Koblenz) (patented)</p>	<p>NUMBER OF RODS</p> <p>5</p> 	<p>Rif. report reference N° R27182-20130522</p> 
<p>EN 1634-1</p>  <p>30 min.</p>	<p>EN 1670</p> <p>Resistenza alla compressione</p> <p>2400 tonnes</p>	<p>MADE IN ITALY</p> 	

Sliding Classics



Information
the product:



Accessories	
Color	Code
	Color white K 6700 CL HD
	Color silver K 6700 CS HD
	Color light grey K 6700 NS HD
	Color yellow K 6700 OL HD
	Color black K 6700 NO HD

Per informazioni sui prezzi e sui rivenditori, visitate il sito Krona Koblenz o contattate il nostro servizio clienti al numero 02 90 90 90 90. Krona Koblenz è un marchio registrato di Krona Koblenz s.p.a. per informazioni sui prezzi e sui rivenditori, visitate il sito Krona Koblenz o contattate il nostro servizio clienti al numero 02 90 90 90 90.





Tabelle di portata (carichi) (K6700) (a guisa di guida di lettura)

K6700 - 50 Kg - N°22 bracci												
2000	50	50	50	50	50	50	50	50	50	48	46	
1950	50	50	50	50	50	50	50	50	50	49	47	
1900	50	50	50	50	50	50	50	50	50	48	46	
1850	50	50	50	50	50	50	50	50	50	48	46	
1800	50	50	50	50	50	50	50	49	47	45	43	
1750	50	50	50	50	50	50	50	48	46	44	42	
1700	50	50	50	50	50	50	49	46	44	43	41	
1650	50	50	50	50	50	50	47	45	43	41	40	
1600	50	50	50	50	50	48	46	44	42	40	38	
1550	50	50	50	49	47	44	42	41	39	37	36	
1500	50	50	50	47	45	43	41	39	38	36	35	
1450	50	50	48	46	44	42	40	38	36	35	34	
1540	50											
	926	700	800	900	950	1000	1050	1100	1150	1200	1250	1300
Loggiate disponibili (m) **												

K6700 - 70 Kg - N°33 bracci												
2000	70	70	70	70	70	69	66	63	61	58	56	
1950	70	70	70	70	70	68	65	62	59	57	55	
1900	70	70	70	70	69	66	63	60	58	55	53	
1850	70	70	70	70	67	64	61	59	56	54	52	
1800	70	70	70	69	66	62	60	57	55	52	50	
1750	70	70	70	67	64	61	58	55	53	51	49	
1700	70	70	69	65	62	59	56	54	52	50	48	
1650	70	70	67	63	60	57	55	52	50	48	46	
1600	70	70	65	61	58	55	53	51	49	47	45	
1550	70	70	63	59	56	54	51	49	47	45	43	
1500	70	68	61	57	55	52	50	47	46	44	42	
1450	70	66	59	56	53	50	48	46	44	42	41	
1730	70											
	900	700	800	900	950	1000	1050	1100	1150	1200	1250	1300
Loggiate disponibili (m) **												

- Testato a platea fissa di 2200 mm. N°22 bracci per 50 Kg e N°33 bracci per 70 Kg.
 ** Con gli elementi di serie, il carico massimo ammissibile è di 50 Kg/m. Per carichi superiori, è necessario utilizzare i bracci rinforzati. Per informazioni sui carichi e sulle condizioni di installazione, consultare il manuale di installazione. I dati sono indicativi e non costituiscono garanzia di resistenza. La responsabilità della scelta e dell'installazione è del cliente.

Spessori di installazione

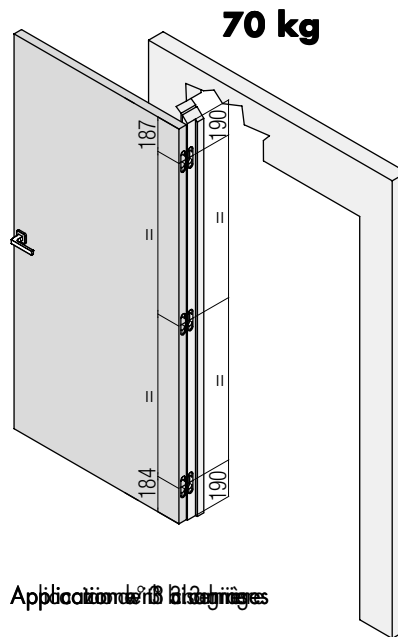
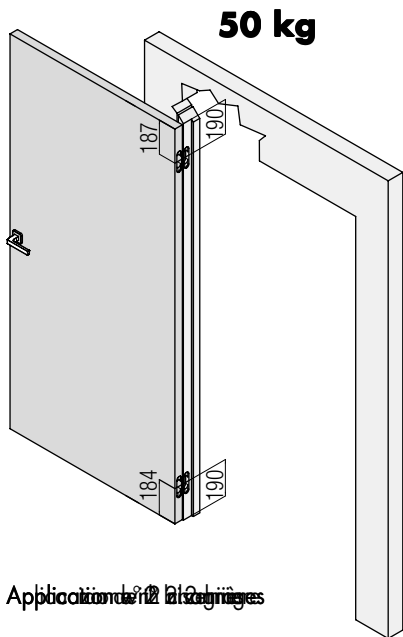

JEM (a guisa di guida di lettura)

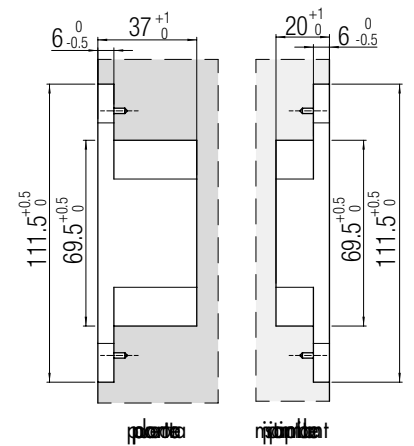

Installazione di JEM in un foro della porta

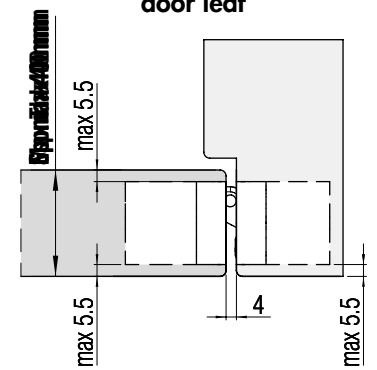

Installazione di JEM in un foro della porta

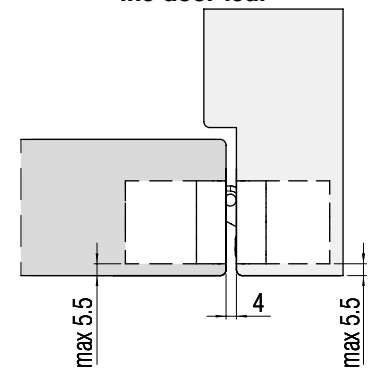

Il sistema è fornito con i componenti necessari per l'installazione. Per informazioni e consigli, consultare il manuale di installazione o il sito web Krona Koblenz.

