

ISTRUZIONI DI MONTAGGIO

VIRTUS

by Bettio

1 BATTENTE CON VITI

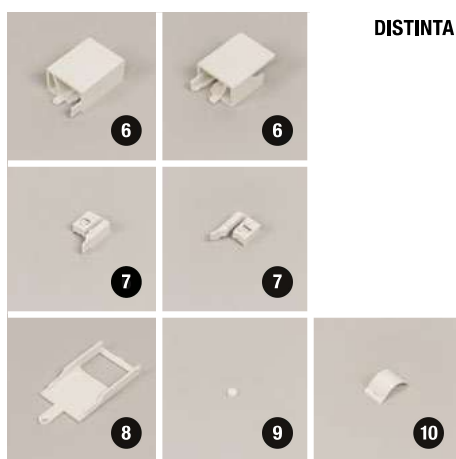
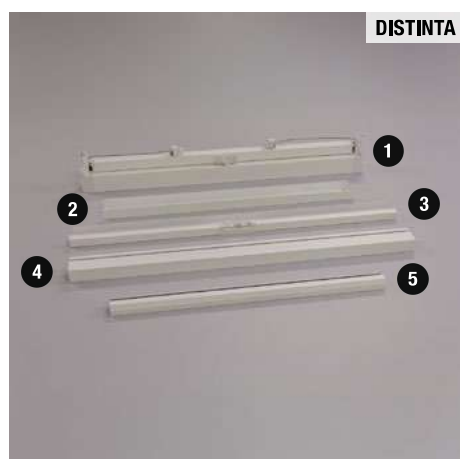

DISTINTA

1. Zanzariera
2. Compensatore superiore
3. Riscontro a muro
4. Guida superiore
5. Guida inferiore
6. Prolunga sx-dx
7. Copri scivolo sx-dx
8. Supporto cassonetto
9. Tappo copertura vite Clic-clak®
10. Molletta di regolazione (x2)

ATTENZIONE

Non tutti gli accessori in plastica verranno utilizzati durante l'installazione.

FUORI SQUADRA

Nel caso in cui il vano abbia un fuori squadra orizzontale compreso tra 4 e 8 mm, consultare la sezione **Mollette di regolazione** prima di installare la zanzariera.

VIRTUS

Virtus può essere installata indistintamente con apertura a sinistra o a destra. È quindi necessario valutare come orientare la zanzariera prima di procedere all'installazione.

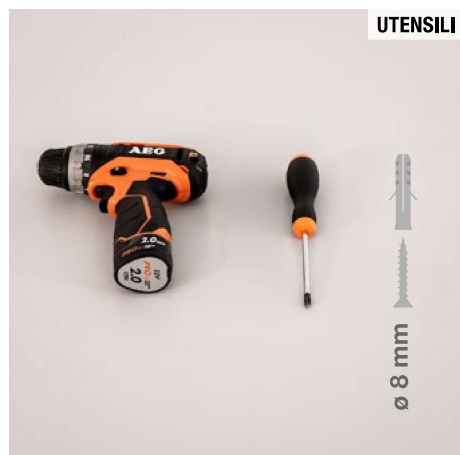

APERTURA DA SINISTRA A DESTRA

Guardando dall'esterno dell'abitazione

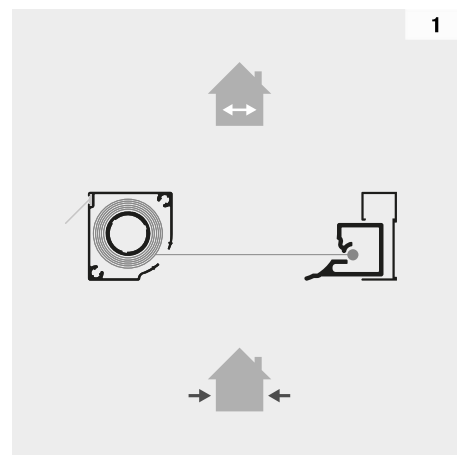

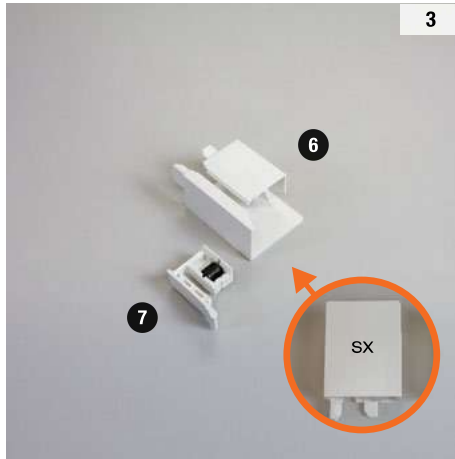

**APERTURA
DA DESTRA
A SINISTRA**

Guardando dall'esterno dell'abitazione

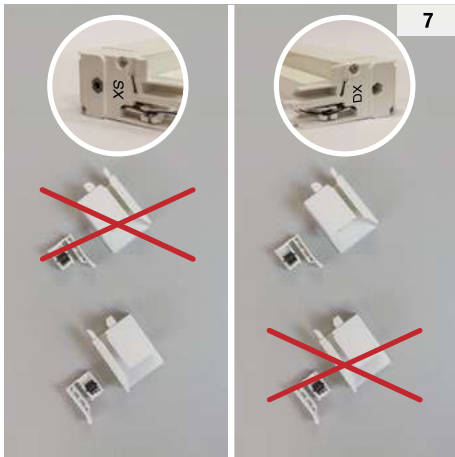
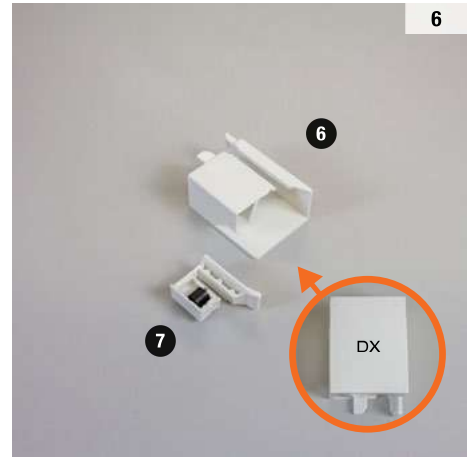
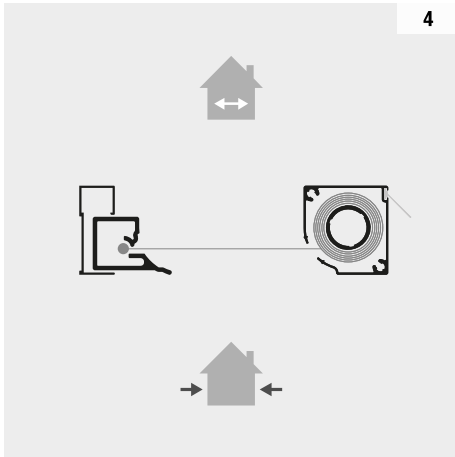

**INSTALLAZIONE
ACCESSORI**

Consigliamo di eseguirla su un piano
di lavoro o una superficie piana.

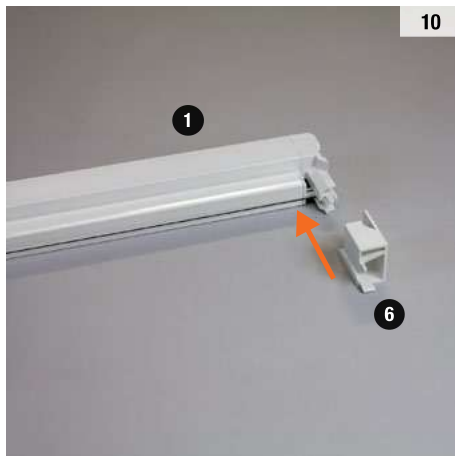
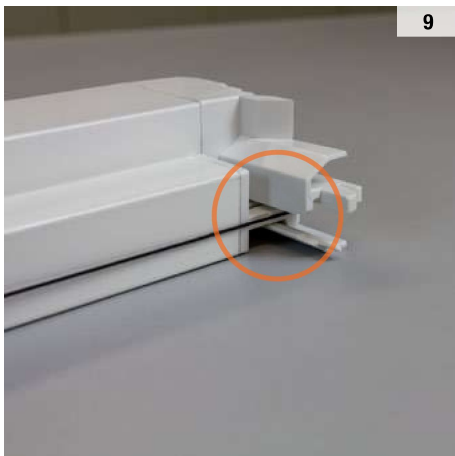
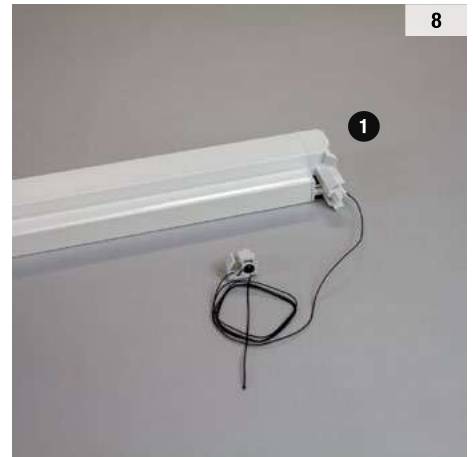

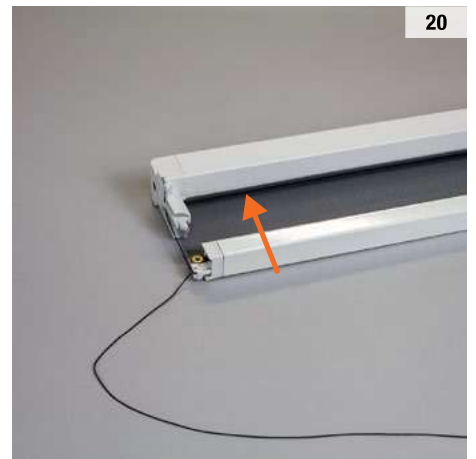
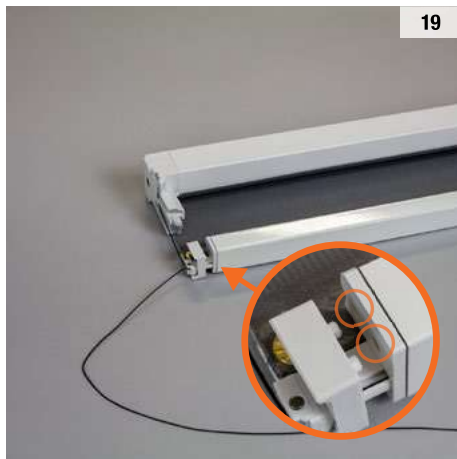
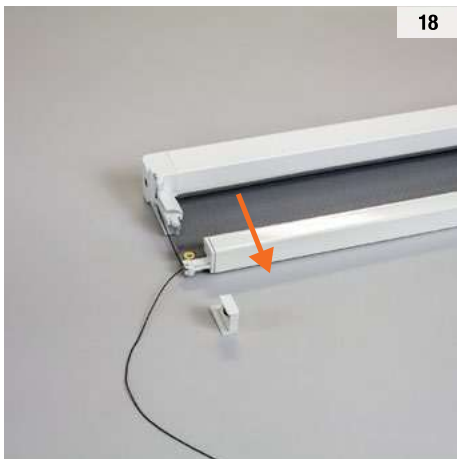
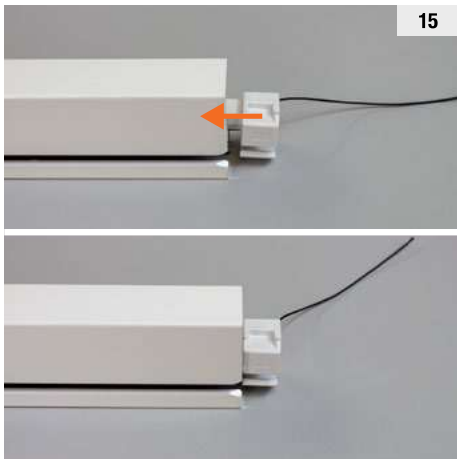
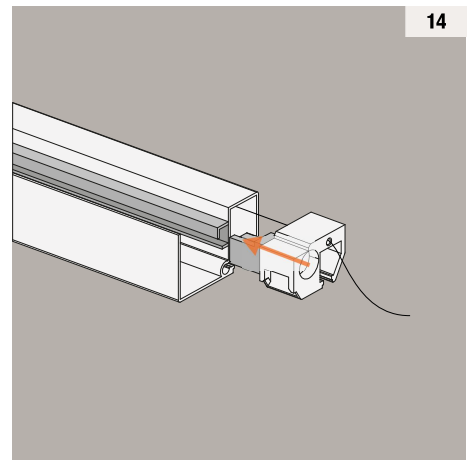
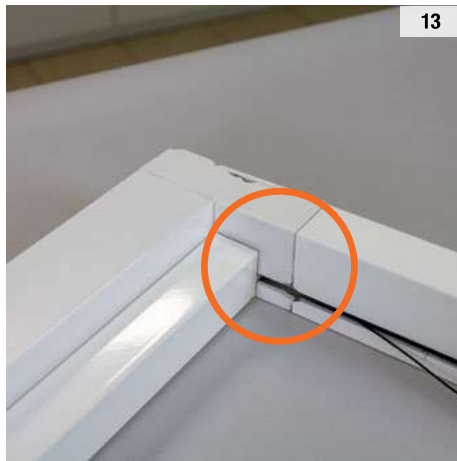
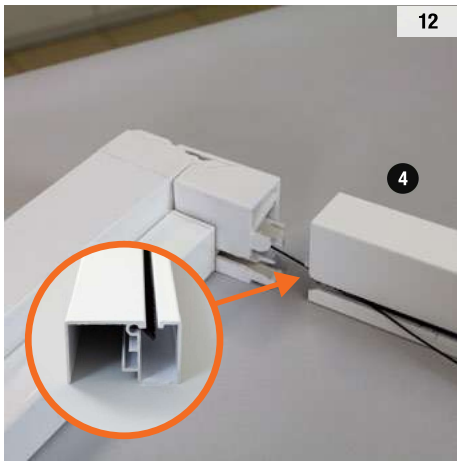

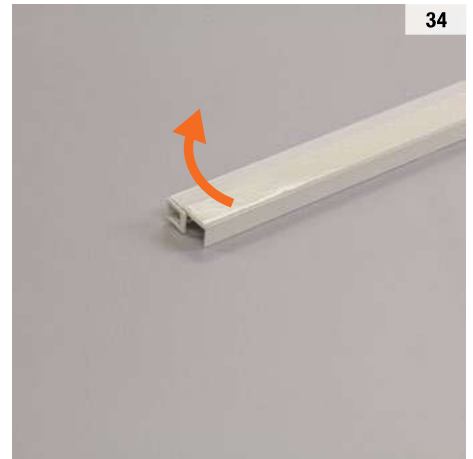
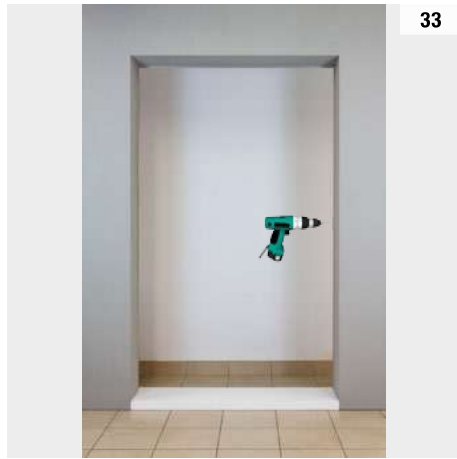
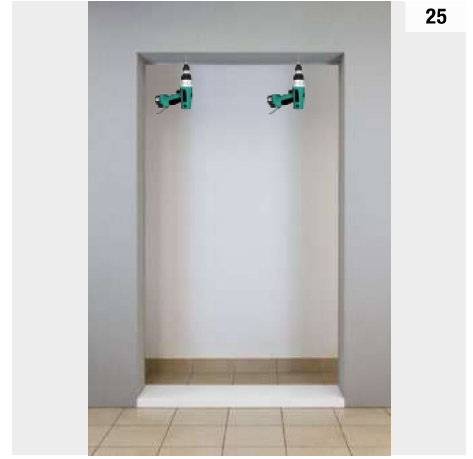
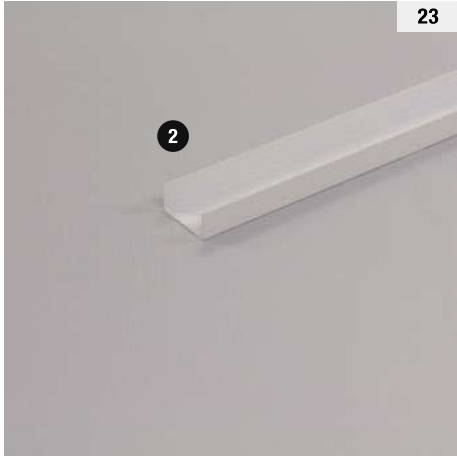



35



36



37



38



39

ATTENZIONE

In caso di fuori squadra orizzontale compreso tra 4 e 8 mm, consultare la sezione Mollette di regolazione



40



41

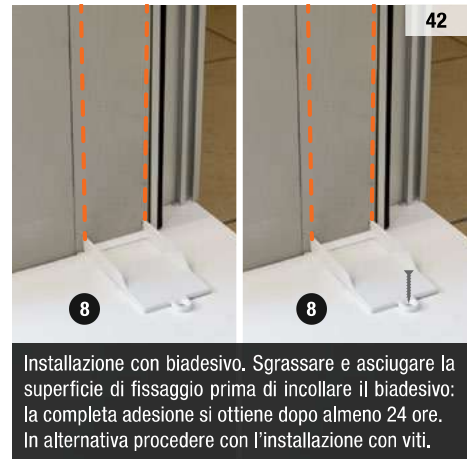

42

Installazione con biadesivo. Sgrassare e asciugare la superficie di fissaggio prima di incollare il biadesivo: la completa adesione si ottiene dopo almeno 24 ore. In alternativa procedere con l'installazione con viti.



43



44



45



46



47



48

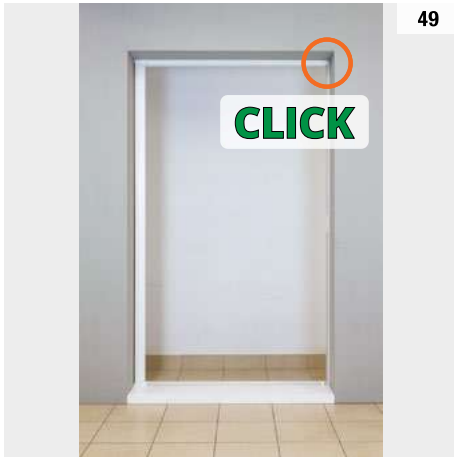

49

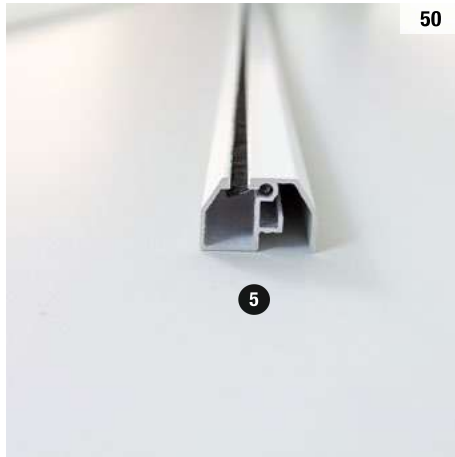

50



51

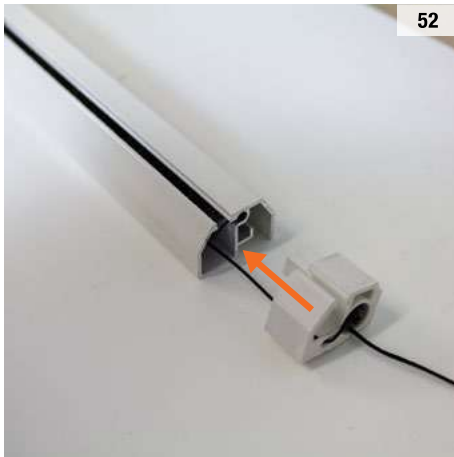

52



53

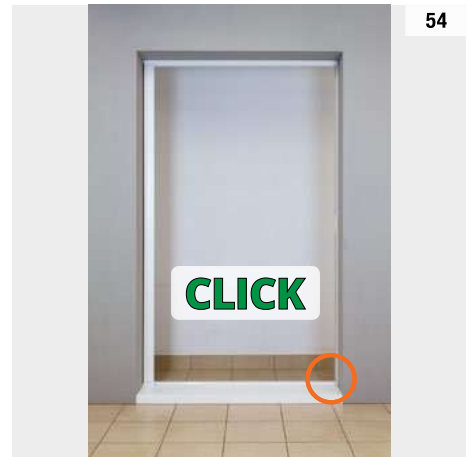

54



55

MOLLETTE DI REGOLAZIONE

Da montare sull'anta mobile solo in caso di fuori squadra orizzontale compreso tra 4 e 8 mm.

FUORI SQUADRA NELLA PARTE ALTA
Installare la molletta nella parte alta.

FUORI SQUADRA NELLA PARTE BASSA
Installare la molletta nella parte bassa.

ZANZARIERA STRETTA
Installare entrambe le mollette in alto e in basso.

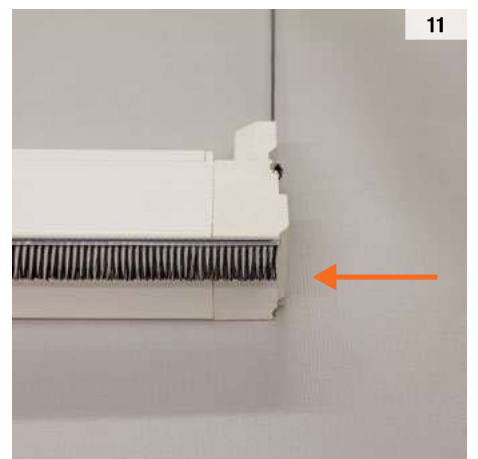
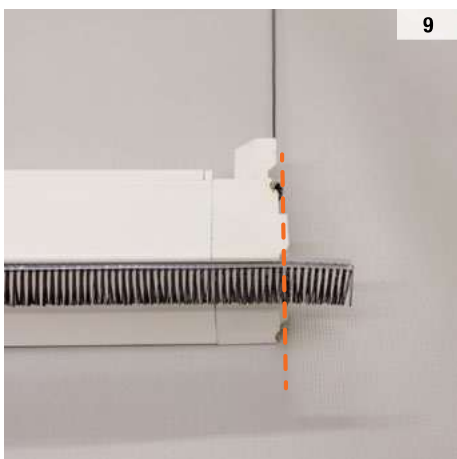
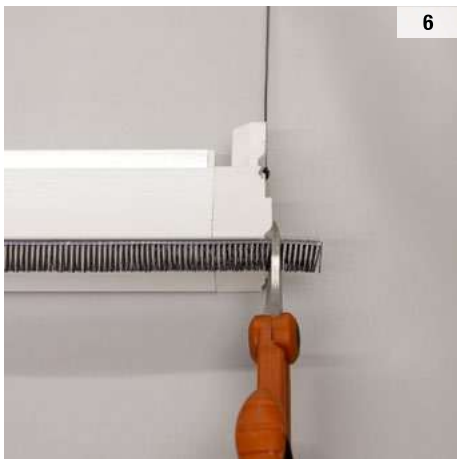
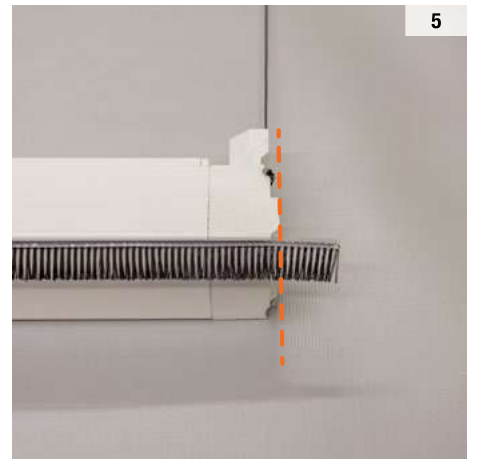
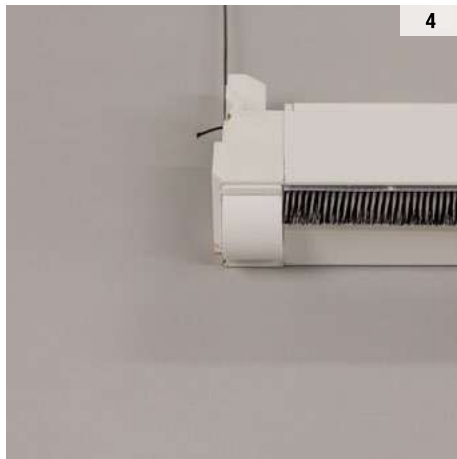
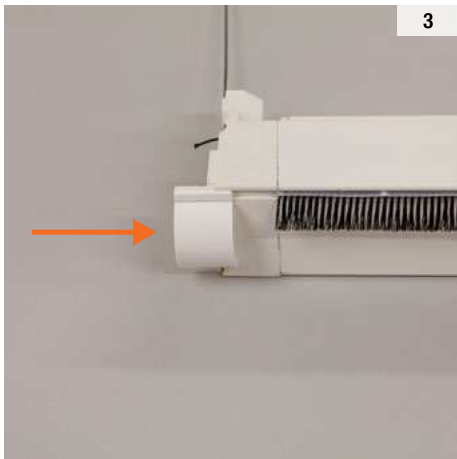
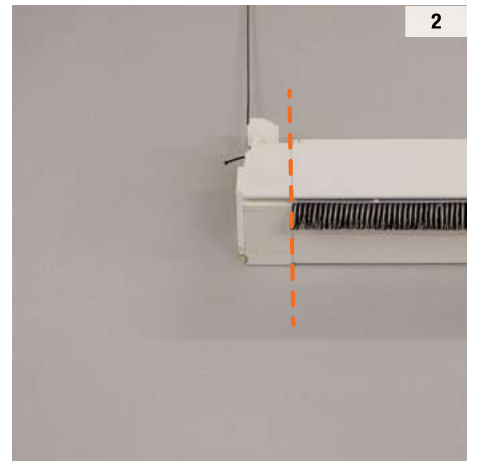
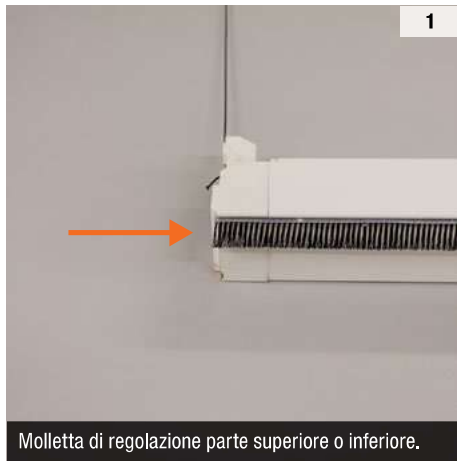

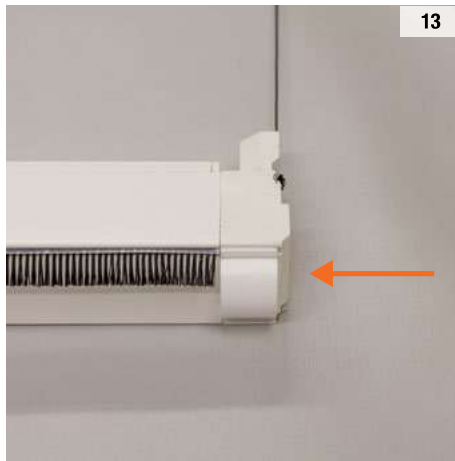

**SISTEMA DI
REGOLAZIONE
MOLLA**

Per zanzariere prodotte
dall'1/12/2025

In caso Virtus faccia fatica a
sganciare o sia troppo reattiva,
è possibile regolare la molla.

1 giro in più o in meno modifica di
molto la reattività della zanzariera.

Per la regolazione usare una
chiave esagonale da 4 mm.

